



World Water Safety

# **INTERNATIONAL LIFESAVING FEDERATION**

## **ILS COMPETITION RULE BOOK**

**Rules, Standards and Procedures for  
Lifesaving World Championships,  
ILS-Sanctioned Competitions and  
ILS Federation Competitions**

2025 Edition

**Revised May 2026**

Gemeenteplein 26, 3010 Leuven, Belgium

Telephone: +32 16 89 60 60

Email: [ils.hq@telenet.be](mailto:ils.hq@telenet.be)

Web: [www.ilsf.org](http://www.ilsf.org)

## ILS COMPETITION RULE BOOK

2025 Edition

First Published August 2025

(Revised May 2026)

### Rules, Standards and Procedures for Lifesaving World Championships, ILS Sanctioned Competitions, and ILS Federation Competitions

Published by the International Life Saving Federation  
Gemeenteplein 26, 3010 Leuven, Belgium  
Telephone: +32 16 89 60 60  
Email: [ils.hq@telenet.be](mailto:ils.hq@telenet.be)  
Web: [www.ilsf.org](http://www.ilsf.org)

© Copyright: The International Life Saving Federation.

The 2025 Edition of the ILS Competition Rule Book (Revised May 2026) is issued by the International Lifesaving Federation (ILS) as part of a comprehensive set of ILS publications.

It replaces the ILS Competition Rule Book, 2025 Edition that was first published in August 2025. The Revised May 2026 Edition comes into effect for ILS and ILS sanctioned competition on 1 June 2026. Any subsequent required changes to the 2025 Edition Rule Book will be advised on the ILS website ([www.ilsf.org](http://www.ilsf.org)) by ILS Bulletin together with an implementation date.

- Note 1:** The original (source) document for this Manual is the Official English version located in the Competitive Lifesaving section of the ILS website. The source document is the authorised reference document and is maintained in terms of all authorised amendments. The ILS may issue bulletins and other documents from time to time to supplement this written publication.
- Note 2:** In any discrepancy between the Official ILS English version of this Rule Book and editions in other languages, the most recent ILS English edition is deemed to be the definitive text. In any discrepancy between the Official ILS English electronic version of this handbook and any print editions, the most recent Official ILS electronic version is deemed to be the definitive text.
- Note 3:** Additional ILS Policies, Manuals and Documents may also be referenced in this Rule Book and published separately that may also apply to this Rule Book and to ILS competition. Such documentation will also be available on the ILS website.

#### Acknowledgments

The ILS acknowledges the many lifesaving organisations and individuals who helped shape lifesaving competition around the world. In particular, ILS acknowledges the 2024 – 2028 ILS Sport Commission, the 2024 – 2028 Rules and Technical Project Working Group and others for their contributions to this Rule Book. These people include: Greg Allum AM - Surf Life Saving Australia – Chair, ILS Anti-Doping Committee, Stephanie Andrews - Royal Life Saving Society United Kingdom, William Barker – French Federation of Lifesaving and First Aid, Jürgen Bonnemann - German Lifesaving Association, John Brennan OAM - Surf Life Saving Australia Limited, Arno Eberle - German Lifesaving Association, Tamer Gaber El-Maghraby – Egyptian Diving and Lifesaving Federation, Ingy El-Elshazly - Egyptian Diving and Lifesaving Federation, Ian Fullagar - Surf Life Saving Australia, Anni Gardiner AM - Royal Life Saving Society Australia, Steven Kent – Surf Life Saving New Zealand – Chair, ILS Athletes Commission, Kiyohiro (Chris) Kurisu - Japan Lifesaving Association, Bruce Matheson - Surf Life Saving New Zealand, Fabio Martins – Brazilian Life Saving Society, Jelle Meintsma - Lifesaving South Africa, Anabel Navio Robles - Royal Spanish Lifesaving Federation, Dr Eil Khan Nouri Mazandarani PhD - Lifesaving and Diving Federation of the Islamic Republic of Iran, Wim Nuyens - Belgian Life Saving Federation, Allen Pembroke - Lifesaving South Africa and Surf Lifesaving Great Britain, Andrea Pennell - Surf Lifesaving Great Britain, Jerry Polesel - Italian Swimming Federation (Lifesaving Section), Dott Giorgio Quintavalle - Italian Swimming Federation (Lifesaving Section), Vijay Kumar SAH – Indian Lifesaving and Lifesaving Sports Federation, Carsten Schleppehorst - German Lifesaving Association, Perry Smith - Lifesaving Society Canada, Simone Spencer - Surf Life Saving New Zealand, Stephen Strange OAM - Surf Life Saving Australia Limited, David (Dave) Thompson AM - Surf Life

Saving Australia – Chair, ILS Sport Commission, Dr Toshiyuki Tamura PhD - Japan Lifesaving Association, Craig Van Rooyen - Lifesaving South Africa, Dr Harald Vervaecke PhD - ILS Secretary General, Carolyn Wilson - Surf Life Saving Australia.

### **Trademarks**

Trademarks (™) of the International Life Saving Federation are World Water Safety ™, Oceanman ™, and Oceanwoman ™, Ocean M ™, ILS Logo ™, ILS Flag ™, ILS Song ™, Rescue Series ™, Lifesaving World Championships ™, World Conference on Drowning Prevention ™, Red over Yellow ™.

### **Copyright**

The contents of this handbook are protected by copyright and may be used only for personal, non-commercial purposes. All other rights are reserved. Commercial uses including publication, broadcast or redistribution in any medium are prohibited, unless authorised in writing by the publisher. Direct enquiries to the headquarters (secretariat) of the International Life Saving Federation.

## TABLE OF CONTENTS

TABLE OF CONTENTS .....	3
TABLE OF FIGURES .....	14
PREFACE .....	15
INTRODUCTION – LIFESAVING AND SPORT .....	19
GLOSSARY OF TERMS .....	20
SECTION 1 THE INTERNATIONAL LIFE SAVING FEDERATION .....	2
1. HISTORY .....	2
1.1 History of the Fédération Internationale de Sauvetage .....	2
1.2 History of World Life Saving .....	2
1.3 History of the International Life Saving Federation .....	2
2. ORGANISATION .....	3
3. STRATEGIC GOALS .....	3
4. SPORT COMMISSION .....	3
5. ATHLETES COMMITTEE .....	3
6. ANTI-DOPING COMMITTEE .....	3
7. EVENT MANAGEMENT COMMITTEE .....	4
SECTION 2 GENERAL RULES AND PROCEDURES .....	2
1. ILS SANCTIONED COMPETITION .....	2
2. COMPETITION ORGANISATION AND ADMINISTRATION .....	2
2.1 Committees, Safety Officer, and Security Officer .....	3
2.2 Organising Committee .....	3
2.3 Competition Committee .....	4
2.4 Safety Officer .....	4
2.5 Security Officer .....	4
3. COMPETITION SAFETY .....	4
3.1 Safety and emergency plan .....	4
3.2 Relocation contingency plan .....	5
4. TECHNICAL, SAFETY AND OTHER OFFICIALS .....	5
4.1 Technical Officials Code of Conduct .....	6
4.2 Local Event Manager .....	6
4.3 ILS Event Director .....	6
4.4 Chief Referee .....	7
4.5 Deputy Chief Referee .....	8
4.6 Area Referee (Ocean) .....	8
4.7 Event Director (Pool) .....	8
4.8 Sectional Referee .....	9
4.9 Referee Steward/Head Scorer .....	9
4.10 Competitor Liaison Officer .....	9
4.11 Course Supervisor .....	10
4.12 Scrutineer Coordinator and Scrutineer .....	10
4.13 Gear and Equipment Coordinator .....	11
4.14 Announcing Coordinator and Commentary Panel .....	11

---

	Judges .....	11
4.15	Chief Judge .....	12
4.16	Finish Judge .....	12
4.17	Lane Judge (IRB) .....	12
4.18	Lane Judge (Pool) .....	13
4.19	Specialist Judge / Judge in Boat .....	13
4.20	Course Judge .....	13
4.21	Electronic Device Specialist Judge .....	14
4.22	Timekeeping Judge .....	14
4.23	Recording Judge .....	14
4.24	Starter .....	15
4.25	Check Starter .....	15
4.26	Marshall .....	15
4.27	Check Marshall .....	16
4.28	Presentation Steward .....	16
4.29	Appeals Committee Convenor .....	17
4.30	Appeals Committee Member .....	17
4.31	Disciplinary Committee Convenor .....	17
4.32	Disciplinary Committee Member .....	17
4.33	Officials Assessor .....	17
4.34	Safety Officer .....	18
4.35	Security Officer .....	18
4.36	Safety and Emergency Management Officer (SEMO) .....	18
4.37	Power Craft Coordinator .....	19
4.38	Water Safety Coordinator .....	19
4.39	Water Safety Personnel .....	20
4.40	Communications Coordinator .....	20
4.41	Medical/First Aid Coordinator .....	20
4.42	Course Statistician .....	21
4.43	Infection Control Marshall .....	21
5.	WORLD RECORDS .....	21
6.	OFFICIAL START AND COMPLETION OF COMPETITION .....	23
7.	PREVAILING CONDITIONS .....	23
8.	VIDEO RECORDING DEVICES .....	23
9.	COMMUNICATION DEVICES IN COMPETITION .....	23
10.	COMPETITION ATTIRE .....	24
11.	AGE CATEGORIES .....	26
11.1	Determining Age Categories .....	26
12.	COMPETITORS WITH A DISABILITY .....	28
13.	TRANSGENDER GUIDELINES .....	28
14.	INTERCLUB, NATIONAL, AND INTERNATIONAL MEMBER COMPETITION TRANSFERS .....	28
15.	ANTI DOPING .....	28
15.1	Drug policy and process .....	28
15.2	Doping control event definitions .....	29

---

16.	CODE OF CONDUCT .....	29
16.1	Code of conduct for competitors, technical Officials, and members .....	29
16.2	Fair-play code for lifesaving competitions .....	29
17.	MISCONDUCT .....	31
17.1	Conduct and discipline generally .....	31
17.2	Competing unfairly .....	31
17.3	Serious discipline offence .....	31
17.4	Disciplinary Committee .....	31
17.5	Notification of Findings .....	32
18.	DISQUALIFICATIONS AND “DID NOT FINISH” CLASSIFICATIONS .....	32
19.	PROTESTS AND APPEALS .....	33
19.1	Types of protests .....	33
19.2	Lodging a protest.....	33
19.3	Protests in Beach Flags .....	34
19.4	Adjudication of protests .....	34
19.5	Appeals Committee and Appeal Panels .....	34
	PROTEST FORM.....	36
	APPEAL FORM.....	37
	WORLD RECORD APPLICATION FORM.....	38
	COMPETITION ORGANISATIONAL STRUCTURE – SCHEMATIC DIAGRAM .....	40
	SECTION 3 POOL EVENTS .....	2
1.	GENERAL CONDITIONS FOR POOL COMPETITION.....	2
2.	THE START .....	3
2.1	Dive start procedure .....	3
2.2	In-water start procedure .....	3
2.3	Disqualification .....	3
3.	MANIKINS .....	4
3.1	Competitors surfacing the manikin .....	4
3.2	Carrying the manikin .....	4
3.3	Towing the manikin .....	5
3.4	Manikin handlers .....	5
4.	SEEDING .....	6
4.1	Seeding in heats.....	6
4.2	Seeding in time-finals .....	6
4.3	Assignment of lanes .....	6
4.4	Seeding in finals .....	7
5.	TIMEKEEPING AND DETERMINATION OF PLACING .....	7
5.1	Automatic officiating equipment .....	7
5.2.	Manual time keeping, finish judging, and officiating.....	8
6.	TECHNICAL OFFICIALS .....	8
7.	OBSTACLE SWIM (200m and 100m).....	9
7.1.	Event description – 200m.....	9
7.2.	Event description – 100m.....	9
7.3.	Equipment .....	9

---

7.4.	Disqualification .....	9
8.	MANIKIN CARRY (50m) .....	10
8.1.	Event description .....	10
8.2.	Equipment .....	10
8.3.	Disqualification .....	10
9.	RESCUE MEDLEY (100m) .....	11
9.1.	Event description .....	11
9.2.	Equipment .....	11
9.3.	Disqualification .....	11
10.	MANIKIN CARRY WITH FINS (100m) .....	12
10.1.	Event description .....	12
10.2.	Equipment .....	12
10.3.	Disqualification .....	12
11.	MANIKIN TOW WITH FINS (100m) .....	13
11.1.	Event description .....	13
11.2.	Equipment .....	13
11.3.	Disqualification .....	14
12.	SUPER LIFESAVER (200m) .....	15
12.1.	Event description .....	15
12.2.	Equipment .....	15
12.3.	Disqualification .....	16
13.	MANIKIN LIFESAVER MEDLEY (100m) .....	18
13.1.	Event description .....	18
13.2.	Equipment .....	18
13.3.	Disqualification .....	19
14.	LINE THROW (12.5m) .....	21
14.1.	Event description .....	21
14.2.	Equipment .....	23
14.3.	Disqualification .....	23
15.	MANIKIN RELAY (4 x 25m) .....	24
15.1.	Event description .....	24
15.2.	Equipment .....	25
15.3.	Disqualification .....	25
16.	OBSTACLE RELAY (4 x 50m) .....	26
16.1.	Event description .....	26
16.2.	Equipment .....	26
16.3.	Disqualification .....	26
17.	MEDLEY RELAY (4 x 50m) .....	27
17.1.	Event description .....	27
17.2.	Equipment .....	28
17.3.	Disqualification .....	28
18.	POOL LIFESAVER RELAY (4 x 50m) .....	29
18.1.	Event description .....	29
18.2.	Equipment .....	30

---

18.3.	Disqualification .....	30
19.	RESCUE TOW RELAY (4 x 50m).....	31
19.1	Event description.....	31
19.2	Equipment .....	32
19.3	Disqualification .....	32
20.	DISQUALIFICATION CODES FOR POOL EVENTS.....	34
SECTION 4 BEACH AND OCEAN EVENTS.....		2
1	GENERAL CONDITIONS FOR BEACH AND OCEAN COMPETITION.....	2
2	THE START .....	3
2.1	Prior to the start.....	3
2.2	The Starter .....	3
2.3	Start procedures.....	3
2.4	Notes .....	4
2.5	Start lines .....	4
2.6	Disqualification .....	4
2.7	Changeovers and tagging in relays.....	5
3.	THE FINISH .....	5
3.1	Judging.....	5
3.2	Time limits .....	6
4.	SEEDING .....	6
4.1	Seeding in heats.....	6
4.2	Seeding in semi-finals and finals.....	6
4.3	Draws for position.....	7
4.4	Beach positions .....	7
4.5	Competitor limits.....	7
5.	SURF RACE.....	9
5.1	Event description.....	9
5.2	The course .....	9
5.3	Judging.....	9
5.4	Disqualification .....	9
6.	SURF TEAMS RACE .....	11
6.1	Event description.....	11
6.2	The course .....	11
6.3	Judging.....	11
6.4	Disqualification .....	11
7.	RESCUE TUBE RESCUE.....	13
7.1	Event description.....	13
7.2	Notes .....	13
7.3	The course .....	14
7.4	Equipment .....	14
7.5	Judging.....	14
7.6	Disqualification .....	14
8.	RESCUE TUBE RACE.....	16
8.1	Event description.....	16

---

8.2	The course .....	16
8.3	Judging .....	16
8.4	Equipment .....	16
8.5	Disqualification .....	16
9.	RUN - SWIM – RUN .....	18
9.1	Event description .....	18
9.2	The course .....	18
9.3	Judging .....	18
9.4	Disqualification .....	18
10.	BEACH FLAGS .....	20
10.1	Event description .....	20
10.2	Start procedure .....	20
10.3	The start .....	20
10.4	Starting infringements .....	20
10.5	Draw for positions .....	21
10.6	Number of competitors eliminated .....	21
10.7	Run-offs .....	21
10.8	The course .....	21
10.9	Equipment and apparel .....	21
10.10	Judging .....	21
10.11	Elimination and disqualification .....	21
11.	BEACH SPRINT (90m and 70m) .....	24
11.1	Event description .....	24
11.2	The start .....	24
11.3	The course .....	24
11.4	Equipment and Apparel .....	24
11.5	Judging .....	24
11.6	Disqualification .....	24
12.	BEACH RELAY .....	26
12.1	Event description .....	26
12.2	The start .....	26
12.3	Baton changeovers .....	26
12.4	The course .....	26
12.5	Equipment and apparel .....	26
12.6	Judging/changeovers .....	26
12.7	Disqualification .....	26
13.	BEACH RUN (2km and 1km) .....	28
13.1	Event description – 2km .....	28
13.2	Event description – 1km .....	28
13.3	The course .....	28
13.4	Equipment and apparel .....	28
13.5	Judging .....	28
13.6	Disqualification .....	28
14.	BEACH RUN RELAY (3 x 1km) .....	30

---

14.1	Event description – 3 x 1km .....	30
14.2	The course .....	30
14.3	Equipment and apparel .....	30
14.4	Judging .....	30
14.5	Disqualification .....	30
15.	SURF SKI RACE .....	32
15.1	Event description .....	32
15.2	The course .....	32
15.3	Dry Start and Dry finish .....	32
15.4	Equipment .....	33
15.5	Judging .....	33
15.6	Disqualification .....	33
16.	SURF SKI RELAY .....	35
16.1	Event description .....	35
16.2	The course .....	35
16.3	Equipment and apparel .....	35
16.4	Judging .....	35
16.5	Control of craft .....	35
16.6	Masters Ski Relay Course and Procedure Variation .....	36
16.7	Disqualifications .....	36
17.	BOARD RACE .....	39
17.1	Event description .....	39
17.2	The course .....	39
17.3	Equipment .....	39
17.4	Judging .....	39
17.5	Control of Craft .....	39
17.6	Disqualification .....	40
18.	BOARD RELAY .....	42
18.1	Event description .....	42
18.2	The course .....	42
18.3	Equipment .....	42
18.4	Judging .....	42
18.5	Control of craft .....	42
18.6	Masters Board Relay Course and Procedure Variation .....	43
18.7	Disqualification .....	43
19.	BOARD RESCUE .....	46
19.1	Event description .....	46
19.2	The course .....	46
19.3	Equipment .....	46
19.4	Judging .....	46
19.5	Control of victim or board .....	46
19.6	Victim pick-up .....	47
19.7	Disqualification .....	47
20.	OCEANMAN/OCEANWOMAN .....	49

---

20.1	Event description .....	49
20.2	The course .....	49
20.3	Masters Oceanman/Oceanwoman Variation .....	50
20.4	Equipment .....	50
20.5	Judging .....	50
20.6	Contact with craft.....	50
20.7	Disqualification .....	50
21.	OCEAN M (INDIVIDUAL).....	53
21.1	Event description .....	53
21.2	The course .....	55
21.3	Equipment .....	56
21.4	Judging .....	56
21.5	Contact with craft.....	56
21.6	Disqualification .....	56
22.	OCEANMAN/OCEANWOMAN ELIMINATOR VARIATION.....	58
22.1	Event Description .....	58
22.2	Disqualification .....	58
23.	OCEANMAN/OCEANWOMAN RELAY.....	59
23.1	Event description .....	59
23.2	Equipment .....	60
23.3	Judging .....	60
23.4	Contact with craft.....	60
23.5	Masters Oceanman/Oceanwoman Relay Procedure Variation .....	60
23.6	Disqualification .....	60
24.	OCEAN M LIFESAVER RELAY.....	61
24.1	Event description .....	61
24.2	The course .....	61
24.2	Course Variations.....	62
24.4	Disqualification .....	62
25.	DISQUALIFICATION CODES FOR BeaCH and OCEAN EVENTS .....	64
SECTION 5 SIMULATED EMERGENCY RESPONSE COMPETITION .....		2
1.	GENERAL CONDITIONS FOR SIMULATED EMERGENCY RESPONSE COMPETITION .....	2
1.1	Security and lock-up.....	3
1.2	Competition start .....	3
1.3	Competition Arena: Aquatic Environment (Wet SERC) .....	3
1.4	Competition Arena: Non- Aquatic Environment (Dry SERC) .....	3
1.5	Situation scenarios .....	4
1.6	Victims, manikins, and bystanders .....	4
1.7	Equipment .....	4
1.8	Start and timekeeping .....	5
2.	PRINCIPLES OF RESCUE.....	5
2.1	Lifesaver versus lifeguard response .....	5
3.	JUDGING AND MARKING.....	6
3.1	Marking system .....	6

---

3.2	Disqualification .....	6
4.	DISQUALIFICATION CODES FOR SERC .....	7
	ANNEXURE 1: .....	8
	SERC COACH, COMPETITOR , JUDGE, AND TECHNICAL OFFICIAL'S GUIDE.....	8
	Purpose .....	8
	Definition Of Terms.....	8
	Marking System .....	8
	Marking Scale.....	9
	WET SERC .....	10
	WEIGHTING FACTOR.....	10
	OVERVIEW OF WEIGHTING FACTOR FOR CHIEF JUDGE SCORE SHEET .....	10
	SAMPLE SCENARIO DESIGN WITH WEIGHTING FACTORS .....	12
	Scenario Description: .....	12
	Victims:.....	12
	Judge Scoring Sheets.....	13
	SAMPLE POOL SETUP, EQUIPMENT AND VICTIMS.....	14
	Scenario.....	14
	SAMPLE WET SERC JUDGING SHEETS .....	15
	OVERALL: SAMPLE CHIEF JUDGE SCORING SHEET .....	15
	NON-SWIMMER: SAMPLE JUDGE SCORING SHEET .....	16
	WEAK SWIMMER: SAMPLE JUDGE SCORING SHEET .....	17
	NON-BREATHING VICTIM: SAMPLE JUDGE SCORING SHEET .....	18
	INJURED VICTIM: SAMPLE JUDGE SCORING SHEET .....	19
	BYSTANDER: SAMPLE JUDGE SCORING SHEET .....	20
	DRY SERC .....	21
	VICTIM MEDICAL CONDITIONS .....	21
	SCENARIO DESIGN.....	21
	WEIGHTING FACTORS .....	21
	TREATMENT .....	21
	EQUIPMENT .....	21
	SAMPLE DRY SERC JUDGING SHEETS .....	22
	CARDIAC EVENT / NON BREATHING VICTIM: SAMPLE JUDGE SCORING SHEET .....	22
	BLEEDING: SAMPLE JUDGE SCORING SHEET.....	23
	EMBEDDED OBJECT: SAMPLE JUDGE SCORING SHEET .....	24
	FRACTURE: SAMPLE JUDGE SCORING SHEET .....	25
	SPRAIN/STRAIN: SAMPLE JUDGE SCORING SHEET.....	26
	SEIZURE: SAMPLE JUDGE SCORING SHEET.....	27
	ENVIRONMENTAL – COLD: SAMPLE JUDGE SCORING SHEET .....	28
	ENVIRONMENTAL – HOT: SAMPLE JUDGE SCORING SHEET .....	29

---

BYSTANDER: SAMPLE JUDGE SCORING SHEET .....	30
SECTION 6 SURFBOAT COMPETITION .....	2
1.    GENERAL CONDITIONS FOR SURF BOAT COMPETITION .....	2
1.1.    Luck of prevailing conditions .....	3
1.2.    Competition area .....	3
2.    THE COURSE .....	3
3.    THE COMPETITION .....	6
3.1    Pre-Start .....	6
3.2 The Start .....	6
3.3    The Seaward Journey .....	6
3.4    The Turn .....	7
3.5    The Return Journey .....	7
3.6    The Finish.....	9
4.    RACING FORMAT .....	9
5.    ROUND ROBIN RACING.....	10
6.    PENALTIES AND DISQUALIFICATION .....	12
7.    DISQUALIFICATION CODES FOR SURF BOAT EVENTS .....	12
SECTION 7 INFLATABLE RESCUE BOAT (IRB) COMPETITION .....	2
1.    INDEMNITY.....	2
2.    GENERAL CONDITIONS .....	2
2.1    Safety essentials .....	2
2.2    Pre-competition safety briefing.....	3
2.3    Safety and technical infringements .....	3
2.4    Competitor prerequisites .....	4
2.5    Entry limitations and substitutions .....	4
2.6    Equipment requirements, scrutineering, and compliance .....	4
2.7    The course .....	5
2.8    Course variations .....	5
2.9    Administration and Officials.....	5
3.    PROCEDURE .....	7
3.1    Placing of patients .....	7
3.2    Preparing for the Start.....	7
3.3    The start .....	7
3.4    Proceed to and from buoys .....	8
3.5    The turn and patient pick-up .....	9
3.6    The exit and finish .....	9
3.7    The Changeover (Mass and Teams events only) .....	10
4.    IRB RESCUE .....	10
5.    IRB MASS RESCUE .....	10
6.    IRB TEAMS RESCUE .....	11
7.    IRB RESCUE TUBE.....	11
8.    DISQUALIFICATION.....	12
9.    DISQUALIFICATION CODES FOR IRB EVENTS.....	13

---

SECTION 8 FACILITY AND EQUIPMENT STANDARDS AND SCRUTINEERING PROCEDURES.....	2
1. POOL FACILITY STANDARDS .....	2
1.1 Scrutineering procedure .....	2
1.2 Length .....	2
1.3 Lanes.....	2
1.4 Starting platform.....	2
1.5 Automatic officiating equipment .....	2
1.6 Water.....	2
1.7 Depth.....	2
1.8 Dive start .....	3
1.9 Obstacle Swim, Obstacle Relay.....	3
1.10 Manikin Carry (50m), Super Lifesaver (200m).....	3
1.11 Manikin Carry with Fins (100m), Manikin Tow with Fins (100m), Super Lifesaver (200m), Pool Lifesaver Relay (4 x 50m).....	4
1.12 Rescue Medley (100m).....	4
1.13 Manikin Relay (4 x 25m) .....	4
1.14 Medley Relay (4 x 50m) .....	5
1.15 Line Throw.....	5
1.16 Simulated Emergency Response Competition (SERC).....	5
2. GENERAL ILS EQUIPMENT STANDARDS .....	5
3. POOL EQUIPMENT STANDARDS.....	5
3.1 Rescue Manikins .....	5
3.2 Obstacles .....	6
3.3 Rescue Tubes .....	7
3.4 Swim Fins.....	8
3.5 Throw Lines.....	9
4. BEACH/OCEAN EQUIPMENT STANDARDS .....	9
4.1 Rescue Tubes .....	9
4.2 Swim fins .....	9
4.3 Batons (Beach Flags and Beach Relay).....	9
4.4 Surf Boards .....	9
4.5 Inflatable Rescue Boats (IRB).....	10
4.6 Personal Flotation Devices (PFDs).....	10
4.7 Helmets .....	10
4.8 Wetsuits.....	10
4.9 Surf Boats.....	11
4.10 Buoys and Flags.....	11
4.11 Surf Skis .....	12
4.12 Swimwear .....	12

## TABLE OF FIGURES

FIGURE 1: OBSTACLE SWIM (200M AND 100M) .....	S3-9
FIGURE 2: MANIKIN CARRY (50M) .....	S3-10
FIGURE 3: RESCUE MEDLEY (100M). .....	S3-11
FIGURE 4: MANIKIN CARRY WITH FINS (100M).....	S3-12
FIGURE 5: MANIKIN TOW WITH FINS (100M). .....	S3-13
FIGURE 6: SUPER LIFESAVER (200M).....	S3-15
FIGURE 7: MANIKIN LIFESAVER MEDLEY (100M) .....	S3-18
FIGURE 8: LINE THROW (12.5M). .....	S3-21
FIGURE 9: MANIKIN RELAY (4 X 25M).....	S3-24
FIGURE 10: OBSTACLE RELAY (4 X 50M).....	S3-26
FIGURE 11: MEDLEY RELAY (4 X 50M).....	S3-27
FIGURE 12: POOL LIFESAVER RELAY (4 X 50M).....	S3-29
FIGURE 13: RESCUE TOW RELAY (4 X 50M) .....	S3-31
FIGURE 14: SURF RACE.....	S4-10
FIGURE 15: SURF TEAMS RACE .....	S4-12
FIGURE 16: RESCUE TUBE RESCUE .....	S4-15
FIGURE 17: RESCUE TUBE RACE .....	S4-17
FIGURE 18: RUN – SWIM – RUN .....	S4-19
FIGURE 19: BEACH FLAGS (ONE ELIMINATION PER RUN-THROUGH) .....	S4-23
FIGURE 20: BEACH FLAGS (TWO ELIMINATIONS PER RUN-THROUGH).....	S4-23
FIGURE 21: BEACH SPRINT .....	S4-25
FIGURE 22: BEACH RELAY .....	S4-27
FIGURE 23: BEACH RUN (1KM AND 2KM) .....	S4-29
FIGURE 24: BEACH RUN RELAY .....	S4-31
FIGURE 25: SURF SKI RACE .....	S4-34
FIGURE 26: OPEN AND YOUTH SURF SKI RELAY .....	S4-37
FIGURE 27: MASTERS SURF SKI RELAY.....	S4-38
FIGURE 28: BOARD RACE.....	S4-41
FIGURE 29: OPEN AND YOUTH BOARD RELAY RACE .....	S4-44
FIGURE 30: MASTERS BOARD RELAY RACE .....	S4-45
FIGURE 31: BOARD RESCUE.....	S4-48
FIGURE 32: OPEN AND YOUTH OCEANMAN/OCEANWOMAN.....	S4-51
FIGURE 33: MASTERS OCEANMAN/OCEANWOMAN AND OCEANMAN/OCEANWOMAN RELAY.....	S4-52
FIGURE 34: INDIVIDUAL OCEAN M. ....	S4-57
FIGURE 35: OCEAN M LIFESAVER RELAY .....	S4-63
FIGURE 36: SAMPLE POOL SETUP, EQUIPMENT AND VICTIMS.....	S5-14
FIGURE 37: SURF BOAT RACE .....	S6-5
FIGURE 38: SURF BOAT TURNS AT BUOYS .....	S6-8
FIGURE 40: SURF BOAT RACE OPTIONAL START AND/OR FINISH.....	S6-10
FIGURE 41: TYPICAL IRB COMPETITION AREA .....	S7-6

## PREFACE

The 2025 edition of the ILS Lifesaving Competition Rule Book governs ILS Championships and ILS-sanctioned competitions. The rule book may, at their discretion, be used by member organisations for their domestic competitions. Any changes to or clarifications regarding rules, standards or procedures for ILS competition will be published as bulletins on the ILS website at [www.ilsf.org](http://www.ilsf.org).

For ILS World Championships, consult the relevant Lifesaving World Championships Handbook (at [www.ilsf.org](http://www.ilsf.org)) in conjunction with ILS Lifesaving Competition Rule Book.

In this 2025 edition, the changes reflect Sport Commission initiatives, Sport Regulations Committee recommendations, consultation with key stake holders, and feedback received from ILS members and consultation with key stake holders. The key changes for the 2025 edition are highlighted in yellow for ease of reference. The Sport Commission draws your attention to the following significant changes to the previous Edition ILS Competition Rule Book:

**General** Various formatting, editorial, and other changes that do affect the conduct or rules of competition.  
Updated wording to note that the changes to ILS Lifesaving Competition Rule Book reflect Sport Commission initiatives, Sport Rules and Technical Project Working Group recommendations, consultation with the ILS Athletes Commission Chair, other key stake holders, and feedback received from ILS members.

### **Section 1 The International Lifesaving Federation**

**General** Various formatting, editorial, and other changes that do affect the conduct or rules of competition.

S1-6 Added the new Anti-Doping Committee.

### **Section 2 General Rules and Procedures**

**General** Various editorial and other changes that do affect the conduct of competition.

S2-2.3 Added Athlete Representatives to the list that Competition Committees may consult.

S2-4.4 For the Chief Referee position description added responsibility for pool event paperwork.

S2-4.7 For the Event Director pool position description added, if required, the checking for sticky/tacky substances and swimsuit compliance with ILS standards the checking for sticky/tacky substances (pool events), swimsuits, equipment acceptability (e.g. rescue tubes lines/ropes) and that equipment is correctly placed.

S2-4.21 For Pool Marshall position description added, if required, the checking of swimsuit standards and the illegal use sticky/tacky substances on hands and feet.

S2-4.25 For the Check Starter position description added, if required, the checking for sticky/tacky substances (pool events), swimsuits, equipment acceptability (e.g. rescue tubes lines/ropes) and that equipment is correctly placed.

S2-4.26 Added in water cameras to the list of devices that may be referenced.

S2-4.33 Added a description for the Official Assessor's position.

S2-10 Clarified Competition attire including the cut of swimsuits, as well as the wearing of wetsuits, caps, and helmets.

S2-11 Clarified the table for participation in Reserve and Open Surf Boats, {patients and Handlers in IRBs, and clarified IRB qualifications.

S2-12 Added Transgender Guidelines for competition participation.

S2-15 Reworded the Anti-Doping clauses.

S2-17.2 Added a reference to Beach Flags and special circumstances.

### **Section 3 Pool Events**

**General** Various formatting, editorial, and other changes that do affect the conduct or rules of competition.

S3-2 Reworded the pool start procedures to include the use of whistle commands.

S3-3.1 Further refined the carry rules for clarity.

- S3-3.2 Clarified that within the 5m finish/changeover zone competitors must maintain contact with the manikin until touching the pool wall/edge.
- S3-3.3 Clarified that competitors may stand/walk within the 10m changeover zone while clipping in a manikin.  
**Note:** These changes are also reflected in the rules for respective pool events.
- S3-3.3 The line/rope of the manikin does not need to be fully extended beyond the 10m changeover zone provided that the line/rope has not been deliberately shortened prior to the start of the race. **Note:** These changes are also reflected in the rules for respective pool events.
- S3-3.4 Reviewed who can be a handler, the holding of a manikin, and the wearing of caps by handler.
- S3-3.5 Reviewed the procedures for time keeping and allocation of placings.
- S3-9.1 Clarified when a breath can be taken at the turn of the Rescue Medley event.
- S3-11.2 Clarified that when swimming with a rescue tube the lanyard/harness can be readjusted without penalty.  
**Note:** This change is also reflected in the rules for similar pool events.
- S3-14.1 Added a marked back line to the Line Throw event. Any backward movement by the rescuer within the area defined by this line is not a disqualification. Reviewed the start procedure.
- S3-15.1 The first, second, and third competitors in the Manikin Relay are to leave the water after completing their leg of the race.
- S3-20 Reviewed, combined, and simplified the number of Pool Disqualification Codes.

#### **Section 4 Beach and Ocean Events**

- General Various formatting, editorial, and other changes that do affect the conduct or rules of competition.
- S4-2.3 The start procedures have been further clarified.
- S4-3 The finish procedures for surf ski and surf boat events have been further clarified.
- S4-4.5 The number of competitors in the Ocean M, Ocean M Relay and Eliminator events have been reduced from 24 to 16 competitors.
- S4-10.1 The wording for competitors preparing for the start of Beach Flags has been extensively reviewed and clarified.
- S4-15.3 Reviewed who can be a handler, and the wearing of caps and vests by handlers.
- S4-17.2 Added an alternate finish procedure for Board Races.
- S4-20.1 Reviewed who can be a handler, and the wearing of caps and vests by handlers.
- S4-20.3 Clarified that, if conditions require, a handler may hold a board in the water for the changeover of the Masters Oceanman/woman events.
- S4-21.1 Reviewed who can be a handler, and the wearing of caps and vests by handlers.
- S4-21.1 Added detailed requirements and options for the conduct of major competitions to ensure optimum presentation of events.
- S4-21.2 Modified the start to improve event presentation.
- S4-Figure 34 Updated the Ocean M Course Diagram
- S4-23.2 Reviewed who can be a handler, and the wearing of caps and vests by handlers.
- S4-24 Modified the start and reviewed the need for handlers to improve event presentation.
- S4-Figure 35 Updated the Ocean M Lifesaver Relay Course Diagram.

#### **Section 5 Simulated Emergency Response Competition**

- General Various formatting, editorial, and other changes that do affect the conduct or rules of competition.
- S5-1 Added wording to better describe Wet SERC and Dry SERC events.
- S5-3.1 Deleted reference to the Marking guide and replaced with reference to Annexure 1: "SERC Coach, Competitor, Judge, and Technical Official's Guide." Also deleted the reference to the ILS website for the guide.

Annexure Removed the current sample scenario sheets and replaced with a “SERC Coach, Competitor, Judge, and Technical Official’s Guide”.

## **Section 6 Surf Boat Event**

General Various formatting, editorial and other changes that do affect the conduct or rules of competition.

S6-3.1 Reviewed who can be a handler, and the wearing of caps, helmets, and vests/lifejackets by handlers.

S6-5 Reviewed the rules for Round Robin Racing including point scores, disqualifications, DNFs, and countback procedures for qualification into further rounds of surf boat events.

## **Section 7 Inflatable Rescue Boat (IRB) Events**

General Various formatting, editorial, and other changes that do affect the conduct or rules of competition.

S7-2.4 Reviewed who can be a handler, and the wearing of caps, helmets, and vests/lifejackets by handlers.

S7-2.5 Added wording to clarify substitution of competitors in events.

S7-3.2 Clarified boat management when preparing for a start of events.

S7-3.2 Changed toes to foot for placement on a line at the start and added a definition of foot.

S7-3.3 Clarified boat management for the start of events.

S7-3.4 Clarified and simplified rules for crew positioning in a boat.

S7-3.5 Clarified and simplified rules for turning of buoys.

S7-3.5 Clarified and simplified rules for exiting the boat and finish of events.

S7-3.6 Clarified and simplified rules for changeovers in the IRB Mass Rescue and IRB Teams Rescue events.

S7-3.6 Clarified and simplified rules for IRB Mass Rescue event.

S7-3.6 Clarified and simplified rules for IRB Teams Rescue event.

S7-3.6 Clarified and simplified rules for IRB Rescue Tube event.

## **Section 8 Facility and Equipment Standards and Scrutineering Procedures**

General Various formatting, editorial, and other changes that do affect the conduct or rules of competition.

S8-3.1 Added the Weitz Manikin to list of ILS approved rescue manikins.

S8-3.3 Added the types of tubes that have been used in ILS Lifesaving World Championships.

S8-4.3 Clarified the specification for Batons (Beach Flag and Beach Relay).

S8-4.11 Amended the minimum weight of Surf Skis to 17,5kg.

S8-4.12 Changed the term “FINA” to “World Aquatics” (WA) when referring to swimsuit standards.

S8-4.12 Clarified swim wear specifications for swimming and also that board paddlers may wear shirt sleeved protective garments in board races.

### **October 2025 Clarification:**

S3-19.1 The note at the bottom of point C has been clarified to more simply read that before the third competitor releases their contact with the turning wall/edge, the head of the manikin must have broken the surface of the water (October 2025).

### **May 2026 Clarifications:**

**General** Various formatting, editorial, and other changes that do affect the conduct or rules of competition.

**S2-4** Clarification of the roles of Event Director, Referee Steward/Head Scorer, Chief Judge, Electronic Device Specialist Judge, Recording Judge, Starter, Marshall, Check Marshall, Safety Officer, Safety and Emergency Management Officer, Powercraft Coordinator, Water Safety Coordinator, and Statistician.

**S2-10F** Clarification of the caps to be worn by competitors in team events and the identification of teams.

- 
- S2-19 Clarification of the role and the procedures for the Appeals Committee and Panels.
- S3-1E. Clarification that it is permitted to use soaps/lubricants on fins and/or feet to don fins.
- S3.2C Clarification that the top of the manikin's head is the judging point for the manikin carry in relation to the competitor.
- S3.3A. Clarification of what defines the rescue tube to judge the securing of a manikin for the tow and that it is permitted for a tube to be secured under or on the arm
- S3-3G A change that for a tow it is **not** permitted to loop the line of rescue tube around the neck of the manikin.
- Note:** This clarification also applies to S3-11, S3-12, S3-13, and S3-20.
- S3-4C Clarification that a manikin handler is free to release contact with the manikin at their discretion after the rescuer touches the turning edge/wall.
- S3-14C Clarification of the start position for the Line Throw event.
- S3-14D Clarification of a fair throw in Line Throw events.
- S3-15.1O Clarification of competitors leaving the water in the Manikin Relay event.
- S3-16.1F Clarification of competitors leaving the water in the Obstacle Relay event.
- S3-17.1K Clarification of competitors leaving the water in the Medley Relay event.
- S3-18.1L Clarification of competitors leaving the water in the Pool Lifesaver Relay event
- S3.19.1L Clarification of competitors leaving the water in the Rescue Tow Relay event.
- S4-4.3 Clarification of the draw and seeding process for ocean events.
- S4-3A Clarification of the correct finish of events where competitors cross a finish line on their feet.
- S4-22.1 Amendment of the note for the Eliminator format for Oceanman, Ocean M, and Ocean M events to clarify that Organisers have the flexibility to change both the number of competitors qualifying for finals and/or the elimination numbers in each Eliminator race.
- S7-3.4D Clarification of the positioning of the IRB crew are not permitted to sit on the floor of the IRB during a race and, where practical, crews are to be seated on the pontoon.
- S7-3.5D Clarification of the patient turn and pick up in IRB races.
- S7-3.6F Clarification of the exit and finish in IRB events.
- S8-1.7 Clarification of pool surveys for ILS event sanctioning purposes.
- S8-4 Clarification of the ski weight and a process to bring underweight surf boards, boats, and skis up to weight.

## INTRODUCTION – LIFESAVING AND SPORT

The International Lifesaving Federation (ILS) is the world authority for drowning prevention, lifesaving, and lifesaving sport. The ILS is a non-profit, non-political, non-religious, worldwide lifesaving sport and humanitarian organisation. The ILS leads, collaborates, and partners with national and international organisations to prevent drowning, to promote the provision of lifesaving services and oversee lifesaving sport throughout the world.

The ILS (and ILS Member Organisations) promotes and organises lifesaving sport and regularly organises international lifesaving competitions to stimulate the interest of competitors to improve their ability and willingness to save people who are in danger in the aquatic environment. Lifesaving sport helps develop the lifesavers' skills, knowledge, and techniques, and plays a vital role in providing opportunities to enhance global relationships among ILS Member Organisations. The ILS Motto is: be fit to save a life.

The ILS is a member of or has relations with the following International Sport Organisations:

- The International Olympic Committee (IOC): The ILS is an IOC recognised International Federation.
- Sport Accord (International Federation regrouping all International Sports Federations): The ILS is a full and voting member of Sport accord.
- The Association of IOC Recognised International Sport Federations (ARISF): The ILS is a full and voting member of the ARISF.
- The International World Games Association (IWGA): The ILS is a full and voting Member of the IWGA.
- The International Masters Games Federation (IMGF): The ILS is a co-opted member of the IMGF.
- The Commonwealth Games Federation (CGF): Lifesaving sport is a recognised sport by the CGF.
- The International Military Sports Council (CISM): Lifesaving is a recognised sport by the CISM.

The ILS also has Official relations with the World Health Organisation (WHO) for drowning prevention activities.

Lifesaving sport engages youth and adults from all nations in the mutual pursuit of excellence in lifesaving. The global focus on cooperation and teamwork to reduce the burden of drowning is a compelling opportunity. Increasing the participation of youth in lifesaving sport is part of the engagement strategy.

Lifesaving sport is an important component of this mission. The ILS Lifesaving World Championships and Lifesaving Regional Championships play an important part in bringing together the world's lifesavers on a regular basis – helping our members learn from the experience of other countries and to challenge themselves to improve and perform.

The public profile and media exposure to lifesaving sport helps profile our vision, mission, values, and strategic goals as the world authority in the global effort to prevent drowning.

We thank the Members and Member Organisations of the ILS Sport Commission and Committees for their dedication in composing the ILS Competition Rule Book, and for their constant endeavours to promote international lifesaving competitions around the world. We congratulate ILS Member Organisations on the continuing growth in participation in lifesaving sport and the Lifesaving Regional and World Championships.

## GLOSSARY OF TERMS

<b>LIFESAVING SPORT:</b>	An activity involving physical effort and skill in which an individual, or team competes against others. The activity can be recreational or competitive, is capable of achieving a result, and is governed by a set of rules issued by the International Life Saving Federation.
<b>DISCIPLINE:</b>	A discipline is a subset of a sport, comprising one or more events of a similar nature. Lifesaving Sport is composed of different disciplines such as: Pool, Ocean & Beach, Simulated Emergency Response Competition (SERC), Surf Boats, Inflatable Rescue Boats, and others.
<b>COMPETITION:</b>	A competition is composed of one or more disciplines.
<b>CHAMPIONSHIP:</b>	A championship is a type of competition. For example, the National Teams Lifesaving World Championships.
<b>EVENT:</b>	An event is a series of races with the same prescribed set of rules and conditions. For example: sprinting and running events, beach flag events, etc.
<b>RACE:</b>	A race is a single contest of speed or distance within an event in which the winner is determined by time or distance. For example, a single heat is a race, the A-final is a race.
<b>HEATS:</b>	Heats are a preliminary set of races which eliminate competitors and in which the winners advance to a next round, quarter final, semi-final, or final race.
<b>ROUND:</b>	A round is a set of heats of the same event. For example, “This round includes 8 heats.”
<b>RUN THROUGH:</b>	Run throughs occur within a round of the Beach Flag event to determine which competitors are eliminated from event during that round of the race.
<b>FINAL:</b>	The final is the final race of the fastest qualifying competitors.
<b>A-FINAL:</b>	An A-final is a race of the 1 <sup>st</sup> to 8 <sup>th</sup> fastest (or placed) qualifying competitors to determine the 1 <sup>st</sup> through 8 <sup>th</sup> places.
<b>B-FINAL:</b>	A B-final is a race of the 9 <sup>th</sup> to 16 <sup>th</sup> fastest (or placed) qualifying competitors to determine the 9 <sup>th</sup> through 16 <sup>th</sup> places.
<b>TIME-FINALS:</b>	Time-finals are a set of races of the same event where there are no qualifying heats. Event winners are determined by time.
<b>ILS:</b>	International Life Saving Federation
<b>FIS:</b>	Fédération Internationale de Sauvetage Aquatique
<b>WLS:</b>	World Lifesaving
<b>IOC:</b>	International Olympic Committee
<b>SERC:</b>	Simulated Emergency Response Competition
<b>IRB:</b>	Inflatable Rescue Boats
<b>LWC:</b>	Lifesaving World Championships
<b>WADA</b>	World Anti-Doping Agency
<b>NADO</b>	National Anti-Doping Organisation (or equivalent WADA recognised national authority)



**World Water Safety  
INTERNATIONAL LIFE SAVING FEDERATION**

**ILS COMPETITION RULE BOOK**

**SECTION 1  
THE INTERNATIONAL LIFE SAVING FEDERATION**



**2025 EDITION  
(Revised May 2026)**

## **SECTION 1**

### **THE INTERNATIONAL LIFE SAVING FEDERATION**

#### **1. HISTORY**

##### **1.1 History of the Fédération Internationale de Sauvetage**

At the end of the nineteenth century, several national lifesaving organisations were working with and learning from each other by exchanging lifesaving techniques and experiences. Organised international lifesaving activities date back to 1878 when an International Congress was hosted in Marseille in the South of France. In the decades since, there have been many independent national and international lifesaving achievements. A need for an international forum to exchange ideas was soon recognised. The dynamic Frenchman, Raymond Pitet organised a lifesaving Congress in 1900 during the Paris World Fair with the purpose of setting up a world federation. He did not initially succeed in achieving this objective at that time but did not give up the idea.

From 25th to 30th January 1910, Paris had to contend with heavy floods and the lifesavers were ever ready to act. These acts of human solidarity from the neighbouring countries incited Raymond Pitet to organise a new Congress, this time in Saint-Ouen, a small town located 7km from the centre of Paris.

At this Congress, the Fédération Internationale de Sauvetage (FIS) was founded on 27th March 1910 by federations from Belgium, Denmark, France, Great Britain, Luxembourg, and Switzerland. Spain and Italy could not attend the meeting but signed the deed of incorporation. FIS was incorporated in France and set up its head office after its foundation in Paris, in the home of Raymond Pitet.

In the following years Congresses and international Championships took place in European countries, but the First World War stopped the expansion of the International Federation. Between the two World Wars, attention was not only given to water rescue but also to road and mountain rescue services. After the Second World War, FIS became a leading authority in drowning prevention and lifesaving sport.

In 1953, the first Pool Lifesaving World Championships took place in Nantes - France. This was the start of the regularly organised world Championships.

The FIS grew from 8 Founding Members to over 34 Member Organisations in 1993. On 24 February 1993, the FIS merged with the WLS to form the ILS. The FIS was disbanded on 3 September 1994.

##### **1.2 History of World Life Saving**

In November 1956, the National Surf Lifesaving Associations of Australia, New Zealand, South Africa, Ceylon (nowadays Sri Lanka), Hawaii, Great Britain, and the USA (California Branch) created the International Council of Surf Life Saving (ICSLS). On 24 March 1971, at a Congress held in Cronulla, Sydney (Australia) a new organisation called World Life Saving (WLS) was founded by members of the ICSLS. The constitution was adopted on 14 June 1977 with a formal agreement between the foundation nations: Australia, Great Britain, New Zealand, South Africa, and the United States.

WLS was founded for the purpose of establishing educational marine safety and aquatic programmes on a people-to-people basis. In 1974, the first World Surf Lifesaving Championships for National Teams took place in Port Elizabeth and Durban (South Africa). In 1981, the first World Surf Lifesaving Championships for Clubs took place in Kuta Beach, Bali (Indonesia).

The WLS grew from 5 Founding Members in 1971 to over 25 Member Organisations in 1993. On 24 February 1993, the WLS merged with the FIS to form the ILS. The WLS was disbanded on 3 September 1994.

##### **1.3 History of the International Life Saving Federation**

The International Life Saving Federation (ILS) was created at the jointly organised General Assembly of FIS and WLS on 26th February 1993 in Leuven (Belgium) by the Official signing of the merging agreement between the Fédération Internationale de Sauvetage Aquatique (FIS) and World Life Saving (WLS).

On the same date the FIS and WLS agreed on a draft ILS Constitution and draft Byelaws. The ILS was ultimately constituted on Saturday, 3rd September 1994 in Cardiff (United Kingdom). The creation date marks the Official founding of the ILS. The first Lifesaving World Championships under the auspices of the ILS also took place in 1994 in Cardiff and Newquay (United Kingdom) and encompassed both pool and ocean competitions. This Championship and subsequent biennial ILS Championships conducted up until 2012 were called the "Rescue" Championships.

In 2014 the word "Rescue" was replaced with the term "Lifesaving World Championships" (LWC) to better describe the ILS LWC and to delineate from the biennial ILS World Conference on Drowning Prevention.

## 2. ORGANISATION

The supreme authority of the ILS is the General Assembly in which Member Organisations are represented. The General Assembly establishes ILS priorities. The Elective General Assembly is organised every four years and elects a Board of Directors. The Board of Directors conducts the business of the ILS between meetings of the General Assembly and is chaired by the President. The General Secretariat (Headquarters) is currently located in Leuven (Belgium) and houses the administration.

The ILS decentralises its affairs under the management of four Regional Branches. The Branches are established in and for Africa, the Americas, Asia-Pacific, and Europe and are responsible for initiating, supervising, and coordinating regional activities.

The ILS has created Commissions which in turn are composed of Committees responsible for the management, development, and technical aspects of each major ILS field of activity. The four Commissions are: Drowning Prevention, Rescue, Lifesaving Sport, and Business.

The ILS also cooperates with partner organisations, governments, non-government organisations (NGOs) and sponsors to promote lifesaving worldwide. The ILS is a unique international federation in that it sponsors and sanctions athletic competition as an important method of furthering its humanitarian lifesaving work. Lifesaving through competition is one of the established goals.

## 3. STRATEGIC GOALS

The Strategic Goals of ILS are to:

- Build the capacity to reduce drowning within targeted communities.
- Position ILS as the world authority of drowning prevention, lifesaving, and lifesaving sport.
- Reduce the drowning of children globally through partnership and collaboration.
- Expand the scope, reach and recognition of lifesaving sport.
- Create a sustainable business model.
- Establish and promote global best practice.
- Engage with every nation.

## 4. SPORT COMMISSION

The Sport Commission oversees all aspects of lifesaving sport in the international sport arena. The Commission's responsibilities and liaisons include, but are not limited to:

- Sport rules
- Championships
- Sport management
- Anti-doping
- Athletes
- Technical Officials
- Sport education
- Sport development and transformation
- Sport research

The Commission supports the Board of Directors in the facilitation of relationships with collaborating sports organisations.

## 5. ATHLETES COMMITTEE

Since 2018, the ILS includes an Athletes Committee. The ILS Athletes Committee is composed of at least six elected persons from which 50% are men and 50% are women. The Committee is tasked to empower the athlete's representation in the ILS decision-making processes, to support the athlete development in their sporting and non-sporting careers and to represent the athlete's views in the decisions across the ILS. The Chair of the Athletes Committee is a voting member of the ILS Board of Directors.

## 6. ANTI-DOPING COMMITTEE

Since 2024, ILS includes a formal Anti-Doping Committee. The ILS Anti-Doping Committee is composed of Board appointed men and women and is independent of other ILS Commissions and Committees. The Anti-Doping Committee is tasked with maintaining the shared ILS and WADA vision of a world where athletes can participate in a doping free sporting environment. The Chair of the Anti-Doping Committee reports directly through to the ILS Board of Directors.

**Note:** The delivery of Anti-doping requirements including education is the responsibility of ILS National Lifesaving Federations/Organisations (NLFs) and their National Anti- Doping Organisation (NADO) should be their point of contact for Anti-Doping operational matters.

## **7. EVENT MANAGEMENT COMMITTEE**

The ILS Event Management Committee is composed of a Board-appointed Chair, the ILS Event Director (if in place) and representatives from the Sport Commission and/or the ILS membership for the Sport related events and representatives of the Drowning Prevention Commission and/or the ILS membership for Conferences and Drowning Prevention related Events. The ILS Event Management Committee is tasked to supervise the management of the respective ILS Events.



**World Water Safety  
INTERNATIONAL LIFE SAVING FEDERATION**

## **ILS COMPETITION RULE BOOK**

### **SECTION 2 GENERAL RULES AND PROCEDURES**



**2025 EDITION**  
**(Revised May 2026)**

## **SECTION 2**

### **GENERAL RULES AND PROCEDURES**

The sport of lifesaving contributes to the worldwide drowning prevention mission of the ILS. As the international federation for lifesaving sport, the ILS establishes rules for the purpose of ensuring a safe and fair system, within which lifesaving competitions may be regulated and conducted.

The ILS alone shall authorise Lifesaving World Championships (LWC). No ILS member Federation may conduct a Lifesaving competition that purports to be a “world” event without the formal application to, and approval from, the ILS. Further, the words/terms “ILS”, “International Life Saving”, “Lifesaving World Championships”, “LWC”, “Oceanman”, “Ocean M”, “Ocean M Lifesaver Relay”, “Oceanwoman”, “World”, “Lifesaving”, “Life Saving”, “Rescue Series”, “World Lifesaving Championships” and “World Water Safety”, may not be used in connection with any lifesaving competition without formal application and the written consent of the ILS.

#### **1. ILS SANCTIONED COMPETITION**

The ILS alone may sanction other lifesaving competitions. All ILS-sanctioned lifesaving competitions must use ILS rules as documented in the current edition of ILS Competition Rule Book and the applicable eligibility to participate rules, detailed in the current edition of the ILS Life Saving World Championships Handbook.

The ILS sanctions world Championships, international Championships, ILS Regional Championships, and National Championships. The ILS may sanction other international or national competitions.

The purpose of sanctioning is to ensure that all events run under the auspices of the ILS, adhere to a consistent standard, and that they do not damage the image of the ILS. Such events will be run by ILS Full Member Organisations, who have obtained the correct local permissions, and have risk management and insurance processes in place. No record can be broken in events that are not sanctioned by the ILS. All ILS Member Organisations are encouraged to ensure that all of their national events are sanctioned by the ILS.

- A. The host organisation is responsible for completing the application for sanction and for ensuring the sanctioning requirements are met. Applications for sanction must be received by the ILS Regional Secretary and the ILS headquarters. Host organisations should contact the ILS headquarters for applications and application procedures. The ILS Sanctioning Form is available at [www.ilsf.org](http://www.ilsf.org).
- B. For all ILS-sanctioned competition, the ILS shall appoint the Chair of the ILS Sport Commission (or an appointee of the chair) as Official liaison to the host Organising Committee with responsibility for ensuring all terms of the sanction are met.

#### **2. COMPETITION ORGANISATION AND ADMINISTRATION**

- A. All competitions conducted by the ILS (including world Championships) or sanctioned by the ILS and conducted under the authority of ILS Member Organisations are subject to the ILS Competition Rule Book, the constitution of the ILS and of the relevant Member Organisation, and regulations made under those constitutions. Special conditions may apply to some competitions, in which case, the organising authority issues clarifying handbooks, bulletins or circulars that are binding on all participants.
- B. By entering the competition, participants acknowledge their responsibility and duty to know the relevant rules, regulations and procedures that govern that competition.
- C. Competition Organisers must make available all necessary information to enable competitors or clubs to determine their eligibility for entry in the competition and the responsibilities imposed by that entry.
- D. Competition communications should provide other information necessary for the proper conduct of the competition, including for example:
  - The name and nature of the competition.
  - The name and address of the ILS member organising authority.
  - The names and addresses of the Organising Committee with specific notation of the Competition Organiser.
  - A statement to the effect that the competition is “held under the authority and regulations of the ILS and/or ILS Member Organisation” together with an appropriate waiver and disclosure and advice of any ILS event sanction.
  - The venue and date of the competition and the dates, times, and other details regarding briefings, reporting for competition marshalling, competition start, closure of competition, etc. The dates for opening and closing of entries, how (and where) they will be made, and respective entry fees.

- A full description of the proposed competitions. In the case of special events or multi-discipline events, it may also be necessary to include the "legs" and total length of course and other appropriate details.
- Any conditions under which entries may be refused and details of age limits.
- Such information regarding insurance as may be required by the Organiser and/or is appropriate to the competition in terms of responsibility for private property, public liability, and personal accident insurance.
- Details of special specification requirements for equipment (if any), etc., and the time and place of any scrutineering.
- A detailed list of prizes and/or awards allocated and the manner in which results will be determined, and prizes awarded.
- Details of any special procedures or fees for appeals.
- Provisions regarding postponement, abandonment and/or cancellation of the competition and/or the capacity to alter any, or all the events.
- Where appropriate, a reminder of the obligations on competitors to secure the written endorsement from their ILS Member Organisation, club, or other relevant authority.
- The maximum number of competitors/teams in a competition or event and how numbers are to be controlled.
- If appropriate, how equipment may be changed or substituted during an event.
- Details of competition sponsors' requirement in respect to decals to be placed on craft, sponsor identified clothing to be worn by technical Officials, work parties, and competitors, etc. and restrictions (if any) on the display of other sponsor logos or messages on competitors' equipment or clothing.
- Whether (and which) facts are to be judged by appointed Officials.
- The scale of penalties applicable to the competition.
- Water temperatures: average for the date of competition. Air temperature and humidity: average for the date of competition.
- Unusual course hazards or requirements of special equipment: e.g., wetsuit, assistance etc. Clear directions to the race venue and check-in site.

## 2.1 Committees, Safety Officer, and Security Officer

For each competition, the relevant authority appoints an Organising Committee, a Competition Committee, and appropriate safety and emergency personnel. For smaller competitions, it may be appropriate to combine the functions of the committees into a single oversight body.

The relationship between the Organising Committee, Competition Committee and Safety Officers Committees etc. are detailed in the schematic diagram at the end of this Section.

## 2.2 Organising Committee

- A. The Organising Committee shall be responsible for the planning and development of the safety, logistical, and operational organisation of the competition and non-competition aspects of the competition.
- B. The Organising Committee consults with and is responsible to the lifesaving sport authority.
- C. The Organising Committee determines the composition of the Competition Committee and supports the Committee as required. The composition of the Organising Committee depends on the nature of the competition being organised and may include, but is not limited to a Chair, Chief Referee(s), Safety Officer, Security Officer, Competition Committee Chair, Competition Director, Event Director, Technical Adviser, Secretary, and personnel representing secretariat, finance, lifesaving, logistics, catering, gear, accommodation, transport, media, and functions, etc.
- D. Formal records of any meetings of the Organising Committee must be taken and kept.

**Note:** As per the ILS Lifesaving World Championships (LWC) Handbook, ILS will appoint a LWC Event Management Committee (EMC). The LWC EMC is responsible on behalf of the ILS for the overall management of each LWC, as well as the overall ongoing management of the LWC competition through its LWC Competition Committee. The EMC's role includes, but is not limited to, overseeing the organisation of the LWC, and liaising and advising the Host, any Local Organising Committee, and the LWC Competition Committee.

## 2.3 Competition Committee

- A. The Competition Committee shall be appointed by the Organising Committee. The Competition Committee answers competition conduct and organisation questions directed to it prior to commencement of competition and directs all matters relating to the actual delivery and conduct of the competition. The Competition Committee may also consult on any matter relating to the organisation and conduct of the competition. This Committee may, subject to the rules, alter, postpone, or cancel events, or alter the competition venue. The composition of the Competition Committee may include, but is not limited to a Chair, Chief Referee(s), Safety Officer, and relevant emergency personnel, Organising Committee Chair or designate, subject matter experts, and athlete representative(s).
- B. Formal records of any meetings of the Competition Committee must be taken and kept.

**Note:** As per the ILS Lifesaving World Championships (LWC) Handbook, the LWC Event Management Committee (EMC) appoints the LWC Competition Committee.

## 2.4 Safety Officer

- A. A Safety Officer shall be appointed by the relevant authority who must consider and advise the Organising and Competition Committees on all matters relating to competition and non-competition safety, security, and emergency services. For larger competitions it may be appropriate to appoint an emergency and safety committee representing the various role responsibilities. The Chair of such a committee shall be appointed to and advise the Organising and Competition Committees.
- B. Formal records of advice provided must be taken and kept.

## 2.5 Security Officer

Dependent on the competition a discrete Security Officer may also be appointed by the Organising Committee. The Security Officer is not a technical Official's role but is to consider and advise Organising, Competition and Safety Committees on all matters relating to competition and non-competition security. The Security Officer is also responsible for ensuring that an appropriate security plan, procedures and security personnel are in place to secure all participants, spectators, equipment, and "gear" etc. at competition facilities and environments.

Formal records of advice provided must be taken and kept by the Security Officer.

## 3. COMPETITION SAFETY

The provision of safe competitions is essential and a priority in competition planning. The host Organising Committees responsible for the provision of adequate resources to ensure the safety of those involved with the competition.

- A. The host Organising Committee shall appoint a Safety Officer who is responsible for ensuring that all competition facilities and environments are safe for use, and that the appropriate safety plan, equipment, craft, procedures, and emergency personnel are in place to ensure the safety of competitors, Officials, and spectators, etc.
- B. The Safety Officer is a member of the Organising Committee and the Competition Committee.
- C. No competition shall be sanctioned by ILS until the ILS Sport Commission is satisfied that the competition facilities are safe, and that the appropriate safety and emergency plan, equipment, procedures, and personnel are in place.
- D. No ocean event shall be conducted until the Chief Referee or Safety Officer has assessed the surf conditions and reported to the Competition Committee. Only the Competition Committee has the authority to cancel, reschedule, or relocate the competition or event.
- E. The Chief Referee or the appointed coordinator of emergency services (as named in the safety and emergency plan) shall assume control of emergencies arising during competition.
- F. **Note:** It is necessary for a common language to be spoken between the Chief Referee and the coordinator of emergency services. If necessary, an Interpreter may be appointed by the Organising Committee to assist with communication.

### 3.1 Safety and emergency plan

- A. The host Organising Committee shall prepare a safety and emergency plan to ensure:
- The venue(s) are fit and proper for the purposes of competition.
  - The general safety of competitors, competition personnel and spectators.

- The personnel and procedures are in place in case of minor or major emergencies involving injury to or illness of competitors, technical Officials, competition personnel or spectators.
- B. The plan shall:
- Outline the facilities to be used during the competition by competitors, technical Officials, competition personnel, and spectators.
  - Identify the individuals with authority to initiate the plan and the chain of command and coordination of emergency services.
  - Identify safety personnel and protocols including land and water patrols and their respective job descriptions.
  - Identify logistical information necessary for the deployment of emergency services: personnel and their deployment, access to competition venues, equipment, communications protocol and methods, vehicle access, and alternate venue(s).
  - Identify the emergency care facilities including the number, location, and type of first aid sites, the equipment at each site, and the personnel in place or on call to staff these sites. The plan will identify on-site, and off-site medical facilities including the location and contact details of the nearest medical centre and hospital.
  - Identify the protocols for the operation of the emergency vehicle(s) on hand in case of the need to transport patients from or rescue teams to an incident site.
  - Identify the start and finish times of competition in open water to allow for sufficient light for search and rescue (SAR) operations in the event of a missing competitor.
  - Note: Generally the finish time of competition will be a minimum of 90minutes before there is insufficient light to enable an effective SAR operation to be undertaken.
  - Identify available emergency services and their tasking protocols and specify how internal and external agencies and services are to be activated.
  - Specify the decision-making responsibility in the event of death or serious injury to a competitor, technical Official, competition personnel or spectator during the competition.
- C. The plan shall be shared with the local agencies and services expected to participate in case of emergency and shall be explained at team manager and Officials briefings. An outline of the plan including availability and details of emergency medical facilities should also be provided to each team manager and be available and promoted to all competition personnel.

### 3.2 Relocation contingency plan

- A. In open water competition, adverse weather can create extremes in heat or cold, storms, dangerous surf or swell and associated dangers for competitors. Human caused disasters such as pollution of the water and beach cannot be discounted. In pool competition, problems such as water quality, power failure or equipment malfunction may occur.
- B. The host Organising Committee shall prepare a contingency plan to ensure the protocols and procedures are in place in the event adverse weather or other conditions threaten to prevent the conduct of part or all the competition.
- C. The contingency plan shall:
- Identify the decision-making authority and protocol for suspension, cancellation, postponement, or relocation of part or all the competition.
  - Identify alternative locations where part or all the competition may be safely conducted within the set competition time frame.
  - Specify the responsibilities and procedures for communicating decisions and directions concerning suspension, cancellation, postponement, or relocation.
  - Outline the logistical plan for relocating competitors, competition personnel and equipment to an alternate location.
  - Outline the responsibilities for event set-up and re-scheduling at the alternate location(s).  
**Note:** Refer to [www.ilsf.org](http://www.ilsf.org) for further information regarding competition safety and contingency plans, sample safety guidelines, etc.

## 4. TECHNICAL, SAFETY AND OTHER OFFICIALS

The Organising Committee shall arrange for the appointment of Technical Officials. A Technical Official is a person who controls the competition by applying the rules and regulations of the Lifesaving sport and by making judgments on rule infringement, performance, time, or ranking.

#### 4.1 Technical Officials Code of Conduct

- A. All Officials must be accredited by their national governing body for lifesaving sport and Officials' applications must be endorsed prior to notification of appointment as an Official. Note: Other personnel with suitable experience and/or specialist qualifications may be appointed to undertake specialist roles at a competition e.g., timekeeper, recorder, safety, medical, judge in boat, etc. Such personnel will be provided with instructions as to their roles and responsibilities.
- B. Officials may not 'coach' or similarly assist a competing team. An Official found to be in violation of this rule shall be declared ineligible to act further as an Official. Officials who hold seminars or clinics for groups which include competitors are not deemed to be violating this rule.
- C. For additional information, see 2.15 Code of Conduct.
- D. Meetings: Officials are required to attend the appropriate briefings to review judging sheets and event procedures, etc.
- E. Dress: Unless otherwise advised Officials should wear a white or blue top with white or blue shorts, pants, or skirts. Hats should be white or blue. Dependent on the environment appropriate footwear (e.g. white shoes on pool deck) should also be worn. Senior Officials may be provided with distinctive coloured tops to assist identification (e.g. Chief Referee shirts may be red in colour). Protective clothing such as raincoats or anoraks may be worn as appropriate.

**Note:** If the Organiser provides an event specific uniform it should be worn.

#### 4.2 Local Event Manager

The Local Event Manager (or different name with this responsibility) reports to the Organising Committee and, during competition, to the Competition Committee. The Event Manager is responsible for the organisation of the competition within the parameters established by the *ILS Competition Rule Book* and the Organising Committee. The Local Event Manager deals with any issues and represents the Organising Committee at the venue.

#### 4.3 ILS Event Director

At ILS managed events an ILS Event Director will be appointed to support ILS and the ILS Sports Commission in the planning and delivery of Lifesaving World Championships and reports to the Competition Committee for the event.

The Organising Committee for an event shall arrange for the appointment of Officials including but not limited to:

**Technical:**

- Chief Referee
- Deputy Chief Referee
- Area Referee (Ocean)
- Event Director (Pool)
- Sectional Referee
- Referee Steward/Head Scorer
- Competitor Liaison Officers
- Course Supervisor
- Scrutineer Coordinator and Scrutineers
- Gear and Equipment Coordinator
- Announcing Coordinator and Commentary Panel

**Judges**

- Chief Judge
- Finish Judge
- Lane Judge
- Course Judge
- Specialist Judge
- Electronic Device Specialist Judge
- Timekeeping Judge
- Recording Judge
- Starter
- Check Starter

- Judge in Boat
- Marshall
- Check Marshall
- Presentation Steward
- Appeals Committee Convenor
- Appeals Committee Members
- Disciplinary Committee Convenor
- Disciplinary Committee Members
- Officials Assessor

### **Safety Officials**

- Safety Officer
- Security Officer
- Safety and Emergency Management Officers
- Power Craft Coordinator
- Water Safety Coordinators
- Water Safety Personnel
- Communications Coordinator
- Medical/First Aid Coordinator
- Course Statistician
- Infection Control Marshall

**Note 1:** At smaller competitions it may be appropriate for some of the functions of competition Officials to be combined providing that the provision of safety is not compromised.

**Note 2:** At all times those involved at a competition need to be aware of the safety and welfare of competitors, Officials and other personnel and immediately report any observations or concerns.

**Note 3:** Officials should record any infringement of competition rules or conduct violations that may be required to support any actions that have been taken or need to be considered at a later time.

### **Technical Officials**

#### **4.4 Chief Referee**

The Chief Referee shall:

- A. In conjunction with the Competition Committee, be responsible for all matters relating to the actual conduct of the competition and matters, of which, the final settlement is not covered by ILS rules. The Chief Referee will also implement the rules and regulations governing the competition or event being conducted.
- B. Be aware at all times of the safety and welfare of competitors, Officials and other personnel involved in the competition and have the authority to immediately suspend wholly or in part the competition and refer that decision to the Safety Officer and the Competition Committee.

**Note:** The Chief Referee has the authority to initiate and coordinate any search and rescue actions. The Chief Referee must immediately notify the Safety Officer and the Competition Committee of their action.

- C. Respond immediately to any reports of safety concerns directly received from competitors, power craft, water safety personnel, Officials and lifesaving/lifeguard personnel and liaise as appropriate with the Safety Officer and/or the Competition Committee.
- D. Conduct pre and post briefings for senior Officials and/or team managers and/or coaches and/or competitors on the conduct and programme for the competition including entry conditions, timetables, area layouts, special events, safety, and emergency arrangements.
- E. Make any alteration to the programme that they consider necessary and communicate these changes without delay to all interested parties. Any alterations should take into consideration the safety and welfare of both competitors and Officials.
- F. Consider and adjudicate upon reports, protests, breaches of rules and on all matters relating to the conduct of Officials, competitors, coaches, managers, and events. Any decision made may be the subject of appeal as provided for in Sections 2.18 – Protests and Appeals.
- G. Consider and adjudicate on any unbecoming conduct during the competition or event. If considered necessary, refer any offence or offenders to the ILS for consideration of further penalty.

- H. If required exercise the power to disqualify or penalise a competitor. The Chief Referee is not required to give notification of any disqualification or penalty until the conclusion of the relevant event.
- I. Conduct any other briefings when considered necessary with Officials, team managers, coaches, and competitors.
- J. The Chief Referee (Pool) or their designate is also responsible for overseeing and collating all result paperwork relating to each event including any disqualifications and ensuring documentation is received by recording personnel.
- K. Report to the relevant ILS authority on the conduct of the competition together with any appropriate recommendations.

#### **4.5 Deputy Chief Referee**

The Deputy Chief Referee, if appointed, shall:

- A. Assist in the conduct and organisation of the competition, and in the absence of the Chief Referee assume their authority and responsibilities.
- B. Take control of a particular area of the competition with Chief Referee authority or be assigned to a specific role or be designated a specific authority.
- C. Be aware at all times of the safety and welfare of competitors, Officials and other personnel involved in the competition and have the authority to immediately suspend wholly or in part the competition and refer that decision to the Chief Referee.
- D. The Deputy Chief Referee also has the authority to initiate any search and rescue actions if necessary and notify the Safety Officer and Chief Referee or their designate.

#### **4.6 Area Referee (Ocean)**

The Area Referee(s), if appointed, shall:

- A. Be responsible to the Chief Referee or the Deputy Chief Referee for the control and organisation of a specific area or a group of sections or events of the competition including the proper layout of course(s) pertaining to the conditions.
- B. Implement the rules and regulations governing the competition and events being conducted in the particular area of control.
- C. Be aware at all times of the safety and welfare of competitors, Officials and other personnel involved in the competition and have the authority to immediately suspend wholly or in part the competition in that area and refer that decision to the Chief Referee and Safety Officer.
- D. In conjunction with the Safety and Emergency Management Officer, the Area Referee has the authority to initiate any search and rescue actions and immediately notify the Safety Officer and Chief Referee or their designate.
- E. At the Chief Referee's discretion, consider and adjudicate upon protests.
- F. Brief the Sectional Referee/s under their control of any specific requirements to manage their sections.
- G. Provide reports and recommendations to the Chief Referee or Authority on the conduct of the area.

#### **4.7 Event Director (Pool)**

The Event Director(s), if appointed, shall:

- A. Be responsible to the Chief Referee for the control and organisation of a specific area or events of the competition and implement the rules and regulations governing the competition and events being conducted in the particular area of control. The Event Director, if appointed, shall:
  - Whistle the competitors to prepare themselves for the start of the event.
  - Ensure the equipment is set and the Chief Timekeeper has signalled they are ready before whistling competitors to their starting position.
  - Signal to the Starter the competitors are set and hand them over to the Starter; and
- B. If required ensure that **processes are in place to** check that pool event competitors have not used tacky substances on their hands or feet, that swimsuits and equipment being used is acceptable (e.g. rescue tubes lines/ropes have not been illegally shortened), and that all manikins, tubes, fins etc. are correctly positioned for a race.
- C. The Event Director (and the Starter) will be responsible for recalling competitors by whistle signal or other means if, in their opinion, the start conditions were breached, or the start was unfair.

#### 4.8 Sectional Referee

The Sectional Referee, if appointed, shall:

- A. Be responsible to the Chief Referee or Area Referee for the control and organisation of a specific section of the competition including the proper layout of courses(s) pertaining to the conditions.
- B. Implement the rules and regulations governing the competition and events being conducted in the particular section of responsibility.
- C. Be aware at all times of the safety and welfare of competitors, Officials and other personnel involved in the competition and have the authority to immediately suspend wholly or in part the competition in that section and refer that decision to the Area Referee and the Safety and Emergency Management Officer.
- D. In conjunction with the Area Referee, Safety and Emergency Management Officer, the Sectional Referee has the authority to initiate any search and rescue actions and immediately notify the Safety Officer and Chief Referee or their designate.
- E. At the Chief Referee or Area Referee's direction, consider and adjudicate upon protests.
- F. Ensure all appointed Officials are aware of their positions and responsibilities.
- G. Provide reports and recommendations to the Chief Referee or relevant ILS authority on the conduct of the Section.

#### 4.9 Referee Steward/Head Scorer

The Referee Steward/Head Scorer, if appointed, shall:

- A. Act under the supervision of the Chief Referee.
- B. Be responsible for the overall manual and electronic record keeping of all competition events and point scores.
- C. Arrange for the supply and distribution of **any required** result cards and the necessary stationery to conduct events.
- D. Supervise the recording procedures as required for the conduct of the competition and may allocate Recorders to Sectional Referees.
- E. Supervise the collection of **any paper based** results from each section.
- F. Supervise draws for rounds, quarterfinals, semi-finals, and finals as required by the Sectional Referee.
- G. In the case of events where judges use marking sheets to determine the result of an event (e.g., SERC,) the Referee Steward shall liaise with the relevant Referee to determine a result in instances of any compilation errors.
- H. Complete world (and other) record applications for signature by the Chief Referee.
- I. Liaise with media regarding results.
- J. At all times be aware of the safety and welfare of competitors, Officials and other personnel involved in the competition and immediately report any concerns to the relevant Referee or their designate and the Safety Officer. If the matter is a catastrophic event the Official may order an immediate suspension of competition in their area and immediately escalate the matter to the Chief Referee and/or their Area Referee and/or the Safety Officer.

#### 4.10 Competitor Liaison Officer

The Competitor Liaison Officer, if appointed, shall:

- A. Act under the supervision of a Liaison Coordinator (if appointed) and the Area or Sectional Referee.  
**Note:** The Liaison Coordinator will usually be one of the appointed Liaison Officers and will liaise with the Chief Referee to streamline the liaison process to ensure, as far as practicable, the efficient conduct of competition.
- B. Liaise with competitors, coaches, team managers and Officials to provide assistance and communicate any rules and queries related to the conduct of the events.
- C. Be positioned so as to be accessible to competitors, coaches, and team managers.
- D. Advise the Chief Referee, Area Referee or Sectional Referee or Event Director of any concerns raised by competitors, coaches and team managers relating to event conduct, courses, or safety issues.
- E. Provide guidance for competitors, coaches and team managers on protest and appeal procedures and the best method of approach to the Chief Referee involved.

**Note:** Liaison Officers are, at all times, to execute their duties without bias and to demonstrate the maintenance of an open, neutral position in all dealings with Officials, competitors, coaches, and team managers.

- F. Be aware at all times of the safety and welfare of competitors, Officials and other personnel involved in the competition and immediately report any concerns to the Safety Officer and Chief Referee or their designate. If the matter is a catastrophic event the Official may order an immediate suspension of competition in their area and immediately escalate the matter to the Chief Referee and/or their Area Referee and/or the Safety Officer.

#### 4.11 Course Supervisor

The Course Supervisor, if appointed, shall:

- A. Be responsible to the Chief Referee, or Area or Sectional Referee or Event Directors for the safe, proper, and fair layout of courses.
- B. In conjunction with the Safety and Emergency Management Officer, assess the prevailing and expected on-beach and in-water beach conditions for the duration of competition including available beach and sand, tides, current, swell, wind conditions and any other pertinent issues.
- C. Work with the Power Craft Coordinator and other appointed personnel to supervise the laying of and adjustment of in-water courses prior to and during competition to ensure, as far as practicable, compliance with event conditions and to provide for safe, proper, fair, and equal racing conditions for all competitors.
- D. Supervise the setting and adjustment of beach and lifesaving event courses and on-beach courses relating to in-water events to provide, as far as practicable, safe, fair, and equal racing conditions for all competitors.
- E. Liaise with competitors and/or competitor panels, Competition Liaison Officers, and other personnel regarding course conditions.
- F. Be aware at all times of the safety and welfare of competitors, Officials and other personnel involved in the competition and immediately report any concerns to the Chief Referee their designate and/or the Safety and Emergency Management Officer. If the matter is a catastrophic event the Official may order an immediate suspension of competition in their area and immediately escalate the matter to the Chief Referee and/or their Area Referee and/or the Safety Officer.

#### 4.12 Scrutineer Coordinator and Scrutineer

The Scrutineer Coordinator, if appointed, shall:

- A. Act under the supervision of the Chief Referee.
- B. Be responsible for control and organisation of measuring gear and scrutineering equipment to ensure that all craft, boats, and/or equipment is operating, and otherwise, in accordance with the current specifications approved by the ILS.
- C. Arrange for the correct setting up of the scrutineering area and measuring devices.
- D. Ensure the scrutineering standards used are in line with the current gear and equipment specifications as advised by the relevant ILS authority.
- E. Arrange for a programme and timetable for the processing of competition gear and equipment including maintaining of records.
- F. Supervise and roster Scrutineers to allocated positions, times, and particular responsibilities.
- G. Together with appointed Scrutineers, make inspections and examine craft and equipment before the entry of competitors' equipment into the Competition Arena.
- H. Observe competition events and if they consider that the performance of a particular craft, motor or item of equipment appears to exceed the manufacturers' performance specification, they shall make these observations known to the Chief Referee.
- I. If considered necessary, or if requested, arrange for inspections during and/or after an event or competition.
- J. Liaise with the Chief Referee on infringements and any concerns raised by competitors, team managers or coaches.
- K. Provide reports and recommendations to the Chief Referee or Authority on the conduct of the scrutineering programme.

- L. Be aware at all times of the safety and welfare of competitors, Officials and other personnel involved in the competition and immediately report any concerns to the Chief Referee or their designate and/or the Safety Officer. If the matter is a catastrophic event the Official may order an immediate suspension of competition in their area and immediately escalate the matter to the Chief Referee and/or their Area Referee and/or the Safety Officer.

#### **4.13 Gear and Equipment Coordinator**

The Gear and Equipment Coordinator, if appointed, shall:

- A. Act under the supervision of the Chief Referee.
- B. Be responsible for the correct assembly of gear and equipment for the competition.
- C. Supervise the Organising Committee workforce involved in assisting with gear and equipment.
- D. Adjust, replace, and arrange for the repair and security/return of gear and equipment.
- E. Maintain a record of gear and equipment issued to Organising Committee and Officials.
- F. Supervise the relocation of gear and equipment to alternative venues.
- G. Report to the Chief Referee any loss or damage of gear and equipment during the competition.
- H. At the conclusion of the competition ensure all gear and equipment is accounted for, hosed down and properly stored.
- I. Provide a report and recommendations to the Chief Referee or the relevant ILS authority on the conduct of the gear and equipment section.
- J. Be aware at all times of the safety and welfare of competitors, Officials and other personnel involved in the competition and immediately report any concerns to the Chief Referee or their designate and/or the Safety Officer. If the matter is a catastrophic event the Official may order an immediate suspension of competition in their area and immediately escalate the matter to the Chief Referee and/or their Area Referee and/or the Safety Officer.

#### **4.14 Announcing Coordinator and Commentary Panel**

The Announcing Coordinator, if appointed, shall:

- A. Act under the supervision of the Chief Referee.
- B. Be aware of the public announcing and other systems, including dedicated sponsor and ILS promotion themes being put in place by the Organising Committee. The Announcing Co-ordinator shall also liaise with the Safety Officer for health and safety announcements during emergencies.
- C. Supervise roster, location, duties, and responsibilities for announcing panel team members.
- D. Advise and assist in the setting up of the announcing systems and sundry equipment.
- E. Ensure spectators, competitors, coaches, managers, Officials, and workforce personnel are kept reliably informed of the competitions' progress via the announcing team.
- F. Acquaint the announcing team with competition timetable and special events to be announced and ensure the Announcing Team is informative and accurate on competitor details.
- G. Describe and announce the running of events and other announcements requested by the Chief Referee, Safety Officer, or the Organising Committee.
- H. Liaise with presentation section on the announcement of awards, medals, VIP, and sponsor presentations.
- I. Provide a report and recommendations to the Chief Referee or the ILS authority on the conduct of the announcing section.
- J. Be aware at all times of the safety and welfare of competitors, Officials and other personnel involved in the competition and immediately report any concerns to the Chief Referee or their designate and/or the Safety Officer. If the matter is a catastrophic event the Official may order an immediate suspension of competition in their area and immediately escalate the matter to the Chief Referee and/or their Area Referee and/or the Safety Officer.

#### **Judges**

- A. The judges' roles at competitions are many and varied but the principal activity is to supervise and assist with the conduct of events according to ILS rules and the authority of the Chief Referee.

B. All judges are to be aware at all times of the safety and welfare of competitors, Officials and other personnel involved in the competition and immediately report any concerns to the Chief Referee or their designate and/or the Safety and Emergency Management Officer. If the matter is a catastrophic event the Official may order an immediate suspension of competition in their area and immediately escalate the matter to the Chief Referee and/or their Area or Sectional Referee or Event Director and/or the Safety Officer.

C. Dependent on the competition, activities may be combined and fall into the following categories:

#### 4.15 Chief Judge

The Chief Judge shall:

- A. Be responsible to the Chief Referee, Area/Sectional Referee or Event Director.
- B. Supervise or assist in the setting up of courses for events.
- C. Roster, rotate, define position, and allocate duties and responsibilities for area/sectional judges.
- E. Ensure that the appointed finish judges know the number of placings required for each event.
- F. Adjudicate judges or Results Recorders' decisions if necessary.
- G. Report any breach or infringements of rules to the Area/Sectional Referee.
- H. Co-ordinate and confirm results check and sign any required result cards and hand to Sectional Referee.
- I. In conjunction with the Course Statistician note the number of starters and ensure that all competitors complete the course (or are recorded as "DNF") and in emergencies notify the Chief Referee and/or the Safety Officer.

#### 4.16 Finish Judge

The Finish Judge shall:

- A. Assist in the setting up of courses for events.
- B. Determine the order of finishing of competitors.
- C. Report any breach or infringement of rules to the Chief Judge or Area/Sectional Referee or Event Director.
- D. Be positioned on either side of the finish line away from the finishing poles to ensure the best-uninterrupted view of the finish of the event.
- E. Refer to ILS judging aids (e.g., video) if necessary, to determine a finish.
- F. If there is a variance, a majority decision is taken under the supervision of the Referee or the Chief Judge.
- G. Note the results and advise the Chief Judge or Chief Referee.
- H. Where possible and when results have been determined, authorise the issue of placing indicators to competitors.
- I. Assist in the setting up of the courses for events.

#### 4.17 Lane Judge (IRB)

The Lane Judge (IRB) shall:

- A. Be a Judge of fact in relation to the observation of the conduct of an event.
- B. Preferably be appointed in pairs and positioned at each lane for each event.
- C. From their designated beach position observe the complete operation of the crew and ensure that the crew, throughout the event, comply with the general conditions and procedures, particularly with regard to start and finish of events.
- D. At the finish of each event, check the IRB and Motors etc. as required.
- E. Ensure that a member of the crew is present whilst checking the IRB at the conclusion of an event and, where an anomaly is observed, draw it to the attention of another judge and a member of the crew before it is rectified. This will avoid any misunderstanding between the Lane Judges and the competitors.
- F. Observe any aggressive driving when the crew "hits the beach" with such force the Driver cannot control their exit from the IRB and causes the Driver to stumble and fall.

- G. Observe competitors to determine whether immediately prior to exiting the IRB the Driver is seated on the pontoon with both feet on the floor of the IRB prior to swinging their legs outside the IRB to exit.
- H. Be responsible to the Area/Sectional Referee and Chief Judge.

**Note:** Teams should not be penalised until the infringement is reported to the Chief Referee.

#### 4.18 Lane Judge (Pool)

The Lane Judge (Pool) shall:

- A. Be a Judge of fact in relation to the observation of the conduct of an event in the lane(s) they are allocated.
- B. They shall report any breach or infringement of the rules to the Chief Judge, or Area/Sectional Referee or Event Director.

**Note:** Competitors or teams should not be penalised until the infringement is reported to the Chief Referee.

#### 4.19 Specialist Judge / Judge in Boat

The Specialist Judge shall adjudicate on events including but not restricted to SERC.

The Judge in Boat shall adjudicate on ocean events as described.

#### 4.20 Course Judge

The Course Judge shall:

- A. Be a judge of fact in relation to the observation of the conduct of an event.
- B. As far as possible, be positioned in an elevated position, or in a boat in ocean events, as the case may be, to obtain a constant view of the event.
- C. Immediately report any safety concerns or rescue situations to the Chief Referee or their designate and/or the Area Risk and Response Office.
- D. Course Judges in Boat may also function as a rescue boat and shall assist in any rescue situation. The crew should also ensure board riders, other craft and surfers are kept at a reasonable distance (having regard to the type of event being conducted) on each side of the competition area.
- E. Observe, note, and report any breaches of competition or other rules to the Chief Judge, or Area/Sectional Referee or Event Director.
- F. Check the alignment of all buoys before the commencement of, and during the progress of, the competition particularly if a change of conditions occurs.
- G. In IRB events, also observe that the driving and crew techniques comply with Driving and Crew Safety Procedures.
- H. Where Driver and/or crew techniques are considered to be a cautionary matter, the Course Judge(s) shall have the authority to caution the driver and/or crew members of the correct safety techniques. These breaches will be reported to the Chief Referee.
- I. Where driving or crew techniques are considered to be unsafe or dangerous the matter shall be reported to the Chief Referee with a recommendation that the individual driver and/or crew members be either disqualified from the event or disqualified from the event and the remainder of the competition.

**Note 1:** A “cautionary matter” is considered to be a matter where the driver and/or crew members breaches the standard expected of them when put into a situation where common sense and skill are ignored or where they endanger their own safety.

**Note 2:** “Unsafe or dangerous or a Safety Breach” is considered to be where the driver and/or crew members causes or places either their own safety, their IRB, other competitors, or their IRBs at risk of injury or collision.

- J. The Course Judge in Boat shall:
- Report to the Sectional Referee/Chief Judge before the start of the competition to receive instructions.
  - In events where competitors have to round all buoys, be stationed, sea conditions permitting, on the inside of the line of buoys.
  - In Board Rescue and Rescue Tube Rescue and Rescue Tube events function as a Course Judge and Finish Judge and be stationed to readily observe that teams comply with the conditions of the competition and the event rules.

- Observe, note, and report any breaches of competition or other rules to the Chief Judge, or Area/Sectional Referee or who shall adjudicate on the infringement in conjunction with the judge(s) concerned.
- K. In IRB events a Course Judge in Boat and Duty Boat crews shall:
- Transport the Patients out to the buoys when requested by the Chief Referee. When advised, and prior to the event starting, drop the Patients into the water at their allotted buoy.
  - Position their IRB in line with the buoys in such a way that the judge(s) can readily observe that the crews comply with the conditions of the competition and the event rules.
  - Remain in the vicinity of the buoys until all patients are recovered.

#### 4.21 Electronic Device Specialist Judge

- A. The Electronic Device Specialist Judge may be used to judge race phases including the start, finish, and placings and confirm competitors' conduct during events conducted in pool, ocean, and beach environments.

**Note 1:** The ILS Authority shall, at its discretion, nominate which source(s) will be used to determine as its final decision(s).

**Note 2:** Different devices may be used at the same competition, as required, to determine as the final decision.

- B. The Electronic Device Specialist Judge (which include video, finish gates, camera, in water, and drone operators etc.) shall, by the use of devices operated by Officials and/or by an appointed external source (e.g., television/live stream etc.), record races for viewing by appointed judges.

- C. Be responsible to the Chief Judge, or Area/Sectional Referee or Event Director and be positioned/and or set up devices as directed for particular events. Be responsible for the use of electronic recording devices within a section/area.

D. Be responsible for the use of devices within a section/area.

E. Record particular phases of events of events as directed.

F. Electronic Device Specialist Judges may be used to judge and confirm placings and confirm competitors' conduct during the event.

**Note 1:** The organising authority shall, at its discretion, nominate which source(s) will be used to determine its final decision(s).

**Note 2:** Different devices may also be used at the same competition, as required, to determine a final decision.

#### 4.22 Timekeeping Judge

The Timekeeping Judge shall:

- A. Be responsible to the Chief Referee or Chief Judge or Event Director.
- B. Be used to specifically function as timekeepers for events. As such, these judges shall be considered as a "judge of fact."
- C. Time and record all events where a time or a time limit is required or has been imposed by the rules of the event or Sectional Referee.
- D. Be available to carry out an allocated judging role in addition to timekeeping.

#### 4.23 Recording Judge

The Recording Judge shall:

- A. Act under the direction of the Chief Referee or Chief Judge or Event Director.
- B. Liaise with the Marshall and assist with draws and pass on results and draws to the Announcers.
- C. After confirmation of results, record the order in which each placed competitor or team finishes in the event and ensuring that in team events all members of the team are recorded.
- D. Where necessary, ensure the Chief Referee/Chief Judge checks and signs the result card.
- E. Maintain a record of results/disqualifications and ensure results are passed onto the Referee Steward and the Marshall.
- F. Keep a progressive total of any point scores or round robin events if required.
- G. Be available to carry out an allocated judging role in addition to recording when required.

#### 4.24 Starter

The starter shall:

- A. Have, with the Check Starter, at the time the Event Director or Chief Referee hands over competitors, sole jurisdiction over the competitors for the start including any briefing on course conditions.
- B. Prior to the commencement of the first round of each ocean water event the Starter should notify competitors of the starting procedure. Where applicable the Starter shall also advise the number of qualifiers to be taken to any further rounds of an event.
- C. Be elevated or in such a position to best observe that starting conditions are fair and that the Check Starter's signal can be observed.
- D. Ensure that an appropriate signal is given to competitors that a start is imminent.
- E. Recall the competitors by whistle signal, second shot of gun or by some other means, if in their or the Check Starter's opinion the start was unfair.
- F. Have the power to disqualify, or eliminate, a competitor for breaking the start, or for wilfully disobeying their orders, or for any other obstruction during the start.
- G. Notify the Sectional Referee of all disqualifications.
- H. Ensure competitors, Water Safety, Duty Boats, Judges, equipment, and patients (in IRB events) are correctly positioned before starting the event
- I. Refer questions pertaining to event conditions to the Chief Referee.
- J. Be aware at all times of the safety and welfare of competitors, Officials and other personnel involved in the competition and immediately report any concerns to the Chief Referee or their designate and/or the Safety and Emergency Management Officer. If the matter is a catastrophic event the Official may order an immediate suspension of competition in their area and immediately escalate the matter to the Chief Referee and/or their Area Referee and/or the Safety Officer.

**Note:** Whilst starting, it is strongly recommended that ear protection is worn.

#### 4.25 Check Starter

The Check Starter (Break Judge) shall:

- A. Work in conjunction with the Starter.
- B. Be appropriately positioned for the event and signal when competitors are in line and positioned and ready to start.
- C. Be responsible to recall competitors by whistle signal or other means if in their opinion the start conditions were breached, or the start was unfair.
- D. If required check that pool event competitors have not used tacky substances on their hands or feet, that swimsuits and equipment being used is acceptable (e.g. rescue tubes lines/ropes have not been illegally shortened), and that all manikins, tubes, fins etc. are correctly positioned for a race.
- E. If required Check Starters may be called upon to function as Course Judges during an event e.g., relay baton/ changeovers, equipment replacement and gear positioning in team events.
- F. In conjunction with the Starter ensure competitors, Water Safety, Duty Boats, judge(s), equipment, and Patients (in IRB events) are correctly positioned before starting the event.
- G. Be aware at all times of the safety and welfare of competitors, Officials and other personnel involved in the competition and immediately report any concerns to the Chief Referee or their designate and/or the Safety and Emergency Management Officer. If the matter is a catastrophic event the Official may order an immediate suspension of competition in their area and immediately escalate the matter to the Chief Referee and/or their Area Referee and/or the Safety Officer.

#### 4.26 Marshall

The Marshall shall:

- A. Act under the supervision of the Chief Referee, Area/Sectional Referee or Event Director.
- B. Be responsible for ensuring competitors' entries are in order and competitors are marshalled correctly before proceeding to the start line.
- C. If required, report/confirm any competitor team changes to the Chief Referee, Area Referee/Sectional Referee or Event Director.

- D.** Liaise with the Chief Referee, Area/Sectional Referee or Event Director regarding entry conditions, draws, order of events, timetables, sponsor uniforms, courses and other arrangements put in place by the Chief Referee or Organising Committee.
- E.** Ensure all competitors comply with the appropriate ILS general rules of competition.
- F.** Liaise with Scrutineers on competitor compliance with gear and equipment specifications or ILS standards or safety requirements.
- G.** In conjunction with the Check Marshal check of competitor dress (and swim fins when used in an event), and for the improper use in pool events of sticky, tacky, or adhesive substances on hands to improve grip on manikins and rescue tubes, and on feet to improve the push off the bottom of the pool.
- H.** Advise the Chief Referee on any infringements or irregularities.
- I.** Organise draws to be displayed or available to competitors and maintain discipline of competitors in the Marshalling Area.
- J.** Liaise with the Announcers, Recorders, Timekeepers and Stewards regarding entries and draws.
- K.** Assemble the competitors in the order as drawn.
- L.** Ensure competitor numbers in events comply with competitor limitations for the event.
- M.** Liaise with the Chief Referee, Marshall, and Course Statistician to confirm starting numbers in each race in the water.
- N.** Be aware at all times of the safety and welfare of competitors, Officials and other personnel involved in the competition and immediately report any concerns to the Chief Referee or their designate and/or the Safety and Emergency Management Officer. If the matter is a catastrophic event the Official may order an immediate suspension of competition in their area and immediately escalate the matter to the Chief Referee and/or their Area Referee and/or the Safety Officer.

#### **4.27 Check Marshal**

The Check Marshal shall:

- A.** Assist the Marshall.
- B.** Report any competitor team changes to the Marshall, Area/Sectional Referee or Event Director and Chief Referee.
- C.** Report any competitor, equipment infringements or other irregularity to the Marshall and Chief Referee. Note: This includes a check of competitor dress (and swim fins when used in an event), and for the improper use in pool events of sticky, tacky, or adhesive substances on hands to improve grip on manikins and rescue tubes, and on feet to improve the push off the bottom of the pool.
- D.** Assist the Marshall in placing competitors in their order ready for starting and ensuring all competitors names and race numbers have been recorded prior to a race commencing.
- E.** Accompany all competitors to the start line and ensure all competitors are positioned as drawn **for the start and for all legs of relay events.**
- F.** Ensure that all competitors are dressed according to this Manual, or other conditions laid down by the ILS.
- G.** In IRB events, be known as the Patient Marshall and shall ensure that patients (victim) are aware of their buoy position and are safely transported to sea and dropped off at their position in sufficient time to ensure continuity of the event.
- H.** Be aware at all times of the safety and welfare of competitors, Officials and other personnel involved in the competition and immediately report any concerns to the Chief Referee or their designate and/or the Safety and Emergency Management Officer. If the matter is a catastrophic event the Official may order an immediate suspension of competition in their area and immediately escalate the matter to the Chief Referee and/or their Area Referee and/or the Safety Officer.

#### **4.28 Presentation Steward**

The Presentation Steward, if appointed, shall:

- A.** Be responsible to the Chief Referee for the orderly marshalling of competitors and recipients receiving presentations and ensure all trophies and awards are available at the presentation dais.
- B.** Be aware of the ILS and sponsor requirements for presentation, including ILS protocols relating to VIPs.

- C. Liaise with Announcing Coordinator on suitable introduction for awards, medals, and other presentations.
- D. Be aware at all times of the safety and welfare of competitors, Officials and other personnel involved in the competition and immediately report any concerns to the Safety Officer and Chief Referee or their designate. If the matter is a catastrophic event the Official may order an immediate suspension of competition in their area and immediately escalate the matter to the Chief Referee and/or their Area Referee and/or the Safety Officer.

#### 4.29 Appeals Committee Convenor

The Appeals Committee Convenor shall be responsible for appointing an appeals committee to consider and adjudicate all matters referred to it by the Chief Referee.

#### 4.30 Appeals Committee Member

Appeals Committee member shall be responsible for considering and adjudicating on all matters referred to the committee by the Chief Referee. The Appeals Committee Convenor selects appropriate members of the appeals committee to adjudicate individual cases.

#### 4.31 Disciplinary Committee Convenor

The Disciplinary Committee Convenor shall be responsible for appointing a Disciplinary Committee to consider and adjudicate all matters referred to it by the Competition Committee, Chief Referee, or appeals committee (see 2.16 Misconduct in the ILS Lifesaving Competition Rule Book).

#### 4.32 Disciplinary Committee Member

The Disciplinary Committee member shall be responsible for considering and adjudicating on all matters referred to the committee by the Competition Committee, Chief Referee or Appeals Committee. The Disciplinary Committee Convenor selects appropriate members of the Disciplinary Committee to adjudicate individual cases.

#### 4.33 Officials Assessor

The relevant authority may appoint Officials Assessor(s) to assist the relevant authority with identification of talented official(s) up to and including Chief Referees for appointment at future competitions. The relevant authority may also request the Official's Assessor to deliver real time mentoring, coaching and education to improve the performance and competency of identified Officials. The process may include:

- A. Act under the supervision of the Chief Referee.
- B. Prior to the commencement of competition the relevant authority and/or the Officials Assessor advising any selected Official(s) that they have been identified by the relevant authority for assessment and/or mentoring, coaching, and education.
- C. Explain the assessment purpose and the process.
- D. Advise the Official when assessment(s) may occur.
- E. Assess the Official's performance against criteria.
- F. Identify the Official's areas of strength and improvement.
- G. Provide real time mentoring, coaching and education as required.
- H. Provide performance feedback to the Official during and after competition.
- I. Advise the relevant authority of any new observed talent within the technical officials.
- J. Advise the relevant authority during competition if their assessment may require an Official to be replaced.
- K. Submit a formal report of their assessment(s) to the relevant authority following completion of the competition.

**Note:** the relevant authority should also provide formal feedback to the assessed officials.

- L. Be aware at all times of the safety and welfare of competitors, Officials and other personnel involved in the competition and immediately report any concerns to the Safety Officer and Chief Referee or their designate. If the matter is a catastrophic event the Official may order an immediate suspension of competition in their area and immediately escalate the matter to the Chief Referee and/or their Area Referee and/or the Safety Officer.

### **Safety Officials**

#### 4.34 Safety Officer

The Safety Officer shall chair the Safety Committee, provide advice as a member of the Organising Committee and the Competition Committee and shall:

- A. Work in conjunction with the Chief Referee.
- B. Formulate and implement a safety, search and rescue and contingency plan which will provide prompt and effective safety, rescue, and recovery in an emergency situation. This programme shall be considered and approved by the Organising and Competition Committees conducting the event.
- C. Respond immediately to and record any reports of safety concerns directly received from competitors, power craft, water safety personnel, Officials and lifesaving/lifeguard personnel and liaise as appropriate with the Chief Referee and/or the Competition Committee.
- D. Be aware at all times of the safety and welfare of competitors, Officials and other personnel involved in the competition and non-competition support functions and have the authority to immediately suspend wholly or in part the competition whenever there is a credible basis for concluding there is an unacceptable risk of serious injury occurring and refer that decision to the Competition Committee. This safety responsibility and authority includes being alert for, and responding to, infection transmission risks and other welfare risks at a competition.
- E. The Safety Officer has the authority to immediately initiate and coordinate (command and control) any search and rescue actions if necessary and notify the Chief Referee and the Competition Committee.
- F. Co-ordinate other services to provide essential communication, transport, and trained personnel in an emergency.
- G. Brief all associated services prior to the competition to ensure that:
  - All other involved services are aware of their responsibilities; and,
  - All Officials are aware of the safety and emergency plans.
- H. Liaise and coordinate with Medical/First Aid/Emergency/Safety personnel including local emergency groups such as Police, Ambulance, Fire services and relevant government agencies.
- I. Be located in a convenient position during the competition and be available for communication with the Chief Referee at all times.
- J. Brief any lifesaving service and any other designated personnel on the emergency plans and assistance required in case of an emergency.
- K. Provide reports and recommendations to the Chief Referee or the relevant ILS authority on the conduct of the safety systems.
- L. The Safety Officer has the authority to immediately initiate and coordinate (command and control) any search and rescue actions, if necessary, and notify the Chief Referee and the Competition Committee.
- M. Dependant on the size of the event, the Safety Officer may also assume the responsibilities of other roles of the safety team as qualifications and skill allow.

#### 4.35 Security Officer

The relevant authority may appoint a Security Officer. The Security Officer is not usually an Official's role but is to consider and advise Organising, Competition and Safety Committees on all matters relating to competition and non-competition security. The Security Officer is also responsible for ensuring that an appropriate security plan, procedures and security personnel are in place to secure all participants, spectators, equipment, and gear etc. at competition facilities and environments.

Formal records of advice provided must be taken and kept by the Security Officer.

#### 4.36 Safety and Emergency Management Officer (SEMO)

- A. A Safety and Emergency Management Officer must be appointed for each Competition Arena and reports to the Safety Officer.
- B. A Safety and Emergency Management Officer works with the Area and Sectional Referees or Event Directors and course supervisor to:
  - Undertake an initial risk assessment of the area and then continually monitor competition conditions by conducting further risk assessments on a regular basis.
  - Monitor the time events take to complete and note any issues with the competition conditions.
  - Monitor trends in the ratios of competitors starting and finishing events and the reasons for competitors not finishing events.

- In the absence of a Statistician assume the duties of this role including recording the number of starters and finishers and account for any non-finishers in each race. If there is any competitor not accounted for in a race, immediately advise the Safety and Emergency Management Coordinator and then the Sectional Referee/Referee.
  - Obtain, record, and immediately convey feedback from competitors, power craft water safety personnel, Officials, and lifesaving/lifeguard personnel as to the conditions and immediately escalate any reports of safety concerns directly with the Safety Officer and the Area Referee.
- C. The outcomes of such tasks are to be conveyed to the Safety Officer.
- D. A Safety and Emergency Management Officer must be aware at all times of the safety and welfare of competitors, Officials and other personnel involved in the competition and have the authority to immediately suspend wholly or in part the competition whenever there is a credible basis for concluding there is an unacceptable risk of serious injury and refer that decision to the Safety Officer and Chief Referee or their designate.
- E. In conjunction with the Area/Sectional Referee, the Safety and Emergency Management Officer has the authority to initiate any search and rescue actions and immediately notify the Safety Officer and Chief Referee or their designate.
- F. The Safety and Emergency Management Officer may be required to take and keep control as forward coordinator under direction of the Safety Officer or representatives of government agencies. This is to avoid confusion and conflicting directions being given to personnel and contradictory instructions being given in respect to the use of rescue assets and crowd control.

#### 4.37 Power Craft Coordinator

The Power Craft Coordinator, if appointed, shall:

- A. Act under the supervision of the Chief Referee and in emergencies the Safety Officer and/or Safety and Emergency Management Officer.
- B. Provide advice and co-ordinate the recruitment of **rescue craft** and the crews required to conduct the competition at events to be conducted.
- C. Supervise the activities of both the Water Safety Craft and Judge in Boat systems.
- D. Supervise the laying of courses prior and during the competition.
- E. Assume the responsibilities of the Water Safety Coordinator (if not appointed). Supervise the water safety aspects of the competition.
- F. Roster, rotate and brief crews on locations and duties.
- G. Ensure **rescue craft** are serviced and properly equipped during the competition.
- H. Report to the Chief Referee and/or Safety Officer any problems relating to the availability of craft and the ability to provide water safety and judging systems.
- I. Ensure an effective communication system is in place to provide communication to all Referees and Coordinators.
- J. Liaise at all times with the Safety Officer.
- K. Provide reports and recommendations to the Chief Referee or relevant ILS authority on the conduct of the section.
- L. Be aware at all times of the safety and welfare of competitors, Officials and other personnel involved in the competition and immediately report any concerns to the Chief Referee or their designate and/or the Safety Officer. If the matter is a catastrophic event the Official may order an immediate suspension of competition in their area and immediately escalate the matter to the Chief Referee and/or their Area Referee and/or the Safety Officer.

#### 4.38 Water Safety Coordinator

The Water Safety Coordinator, if appointed, shall:

- A. Act under the supervision of the Chief Referee and in emergencies the Safety Officer and/or Safety and Emergency Management Officer.
- B. Be responsible for the safety of competition while water events are in progress.
- C. Supervise and roster water safety personnel.
- D. **Liaise with the Powercraft Coordinator** for the positioning of rescue craft and water safety personnel.

- E. Bring to the attention of the Safety Officer any concerns regarding the level of water safety.
- F. In IRB competition (if appointed) maintain safety for crews and patients in conjunction with the Safety Officer.
- G. In all competitions ensure that water safety meets the prescribed and assessed requirements.
- H. Be aware at all times of the safety and welfare of competitors, Officials and other personnel involved in the competition and immediately report any concerns to the Chief Referee or their designate and/or the Safety Officer. If the matter is a catastrophic event the Official may order an immediate suspension of competition in their area and immediately escalate the matter to the Chief Referee and/or their Area Referee and/or the Safety Officer.

#### **4.39 Water Safety Personnel**

Water Safety Personnel shall:

- A. Act under the supervision of the Water Safety Coordinator and in emergencies the Safety Officer and/or Safety and Emergency Management Officer.
- B. Be positioned on the beach and in the water as directed by the Water Safety Coordinator.
- C. Bring to the attention of the Water Safety Coordinator any concerns regarding the level of water safety at a particular time.
- D. Be responsible for the safety of competition in their appointed water area.
- E. Under the direction of the Water Safety Coordinator assist other areas if required.
- F. In all competition ensure that water safety meets the prescribed and assessed requirements.
- G. Be aware at all times of the safety and welfare of competitors, Officials and other personnel involved in the competition and immediately report any concerns to the Water Safety Coordinator and/or the Safety and Emergency Management Officer. If the matter is a catastrophic event the Official may order an immediate suspension of competition in their area and immediately escalate the matter to the Chief Referee and/or their Area Referee and/or the Safety Officer.

#### **4.40 Communications Coordinator**

The Communications Coordinator, if appointed, shall:

- A. Act under the supervision of the Chief Referee and in emergencies the Safety Officer and/or Safety and Emergency Management Officer.
- B. Ensure effective radio communication is maintained to all senior Officials and IRB's including Organising and Competition Committee members, Safety, Medical and workforce personnel for the duration of the competition.
- C. In conjunction with the Chief Referee or the relevant ILS authority, agree on the required quantity and type of radio equipment required for the competition.
- D. Supervise the central control centre including the issue and maintenance and return of radio equipment.
- E. Publish a list of calls signs/frequencies and radio procedures for the competition.
- F. Provide reports and recommendations to the Chief Referee or relevant ILS authority on the conduct of the section.
- G. Be aware at all times of the safety and welfare of competitors, Officials and other personnel involved in the competition and immediately report any concerns to the Chief Referee or their designate and/or the Safety Officer. If the matter is a catastrophic event the Official may order an immediate suspension of competition in their area and immediately escalate the matter to the Chief Referee and/or their Area Referee and/or the Safety Officer.

#### **4.41 Medical/First Aid Coordinator**

The Medical/First Aid Coordinator, if appointed, shall act under the supervision of the Chief Referee and in emergencies the Safety Officer and/or Safety and Emergency Management Officer.

- A. Be appropriately qualified to undertake the role required given the nature of the competition being conducted and the resources available.
- B. Be responsible for the organisation and operation of the competition medical/first aid service.
- C. Where required, assess the physical and psychological fitness of any competitor or Official and ensure through the Chief Referee that an unfit competitor or Official does not participate for the well-being safety of themselves and/or others involved in a competition.

- D. Acquaint the Chief Referee with any medical decisions that may affect the conduct of the competition.
- E. Be aware of the plan developed by the Organising Committee for the evacuation of casualties and other persons in the event of a serious accident or other incident or implications relating to the safety of competitors, Officials, assisting personnel and/or the public.
- F. Direct the deployment of first aid posts and other medical services and supplies including medical/first aid personnel at the competition venue(s).
- G. Be available through communication and be located in such a position to assist or direct medical or first aid specialists to any medical or first aid incident.
- H. Provide a report and recommendations to the Chief Referee or the relevant ILS authority on the conduct of the medical/first aid section.
- I. Be aware at all times of the safety and welfare of competitors, Officials and other personnel involved in the competition and immediately report any concerns to the Chief Referee or their designate and/or the Safety Officer. If the matter is a catastrophic event the Official may order an immediate suspension of competition in their area and immediately escalate the matter to the Chief Referee and/or their Area Referee and/or the Safety Officer.

#### **4.42 Course Statistician**

The Course Statistician shall:

- A. Act under the direction of the Safety and Emergency Management Officer and/or Sectional Referee/Area Referee.
- B. Maintain the statistical records for the area and ensure that data is handed on to the Referee Steward.
- C. Liaise with the area Marshall to obtain event starters for each race in the water.
- D. **Check (at the start and finish line) and record the number of starters and finishers and account for any non-finishers in each race, and immediately report any non-finishers in events.**
- E. Monitor the time events take to complete and note **and immediately report** any issues with the competition conditions.
- F. Immediately advise the ARRO, and Safety Officer (if the ARRO is not on hand), and then the Sectional Referee/Area Referee (as applicable) if there is any competitor that is not accounted for in a race.
- G. Be aware at all times of the safety and welfare of competitors, Officials and other personnel involved in the competition and immediately report any concerns to the Chief Referee, their designate and/or the Safety and Emergency Management Officer. If the matter is a catastrophic event the Official may order an immediate suspension of competition in their area and immediately escalate the matter to the Chief Referee and/or their Area Referee and/or the Safety Officer.

#### **4.43 Infection Control Marshall**

The Infection Control Marshall (where required for infectious disease incidents such as COVID, etc.) shall:

- A. Act under the direction of the Safety Officer and/or Sectional Referee/Area Referee.
- B. Be visually identifiable and present at all times when designated areas are in operation.
- C. Ensure that all infectious disease control and management plans (where relevant) and/or specific policies/protocols/practices are effectively implemented and are being followed.
- D. Ensure and manage any required mask, handwashing, and cleaning regimes.
- E. Promote and take practical steps to ensure competitors, Officials, coaches, managers, and spectators within their area of responsibility are physical distancing to ensure infection control practices are being followed.
- F. Be aware at all times of the safety and welfare of competitors, Officials and other personnel involved in the competition and immediately report any concerns to the Safety Officer and/or the Sectional/Area Referee and/or the Safety and Emergency Management Officer. If the matter is a catastrophic event the Official may order an immediate suspension of competition in their area and immediately escalate the matter to the Chief Referee and/or their Area Referee and/or the Safety Officer.

### **5. WORLD RECORDS**

- A. The ILS World Records may only be established in a 50m swimming pool and using equipment which comply with ILS standards detailed in Section 8 of the ILS Competition Rule Book.

- 
- B. World records may be established at Lifesaving World Championships, multi-sport games (e.g., World Games), ILS regional Championships, national Championships, or pan-national Championships (e.g., Commonwealth Championships) and at any other championship or competition conducted according to the ILS Lifesaving Competition Rule Book and sanctioned by ILS.
- C. The ILS shall recognise Youth, Open and Masters men's and women's individual world records in all pool events identified in the ILS Competition Rule Book. This includes the 200m Obstacles for Masters competitors. It does not include the 100M obstacle event for Youth and Open competitors and mixed or single gender events in team categories except were conducted in those gender categories at an ILS LWC.
- D. Team(relay) event world records including the Line Throw, Manikin Relay, Obstacle Relay, Medley Relay and Lifesaver Relay events shall be recognised for Open and Youth age categories (national teams and club teams are not separated for record purposes). National teams and Interclub teams must meet the team eligibility requirements as defined in the ILS Lifesaving World Championship Handbook to be eligible to claim a world record.
- Note 1:** The ILS does not recognise separate National and Interclub team world records i.e., only the fastest time is recognised as a world record in each Open and Youth category relay event.
- Note 2:** The ILS does not recognise Masters team (relay) world records.
- E. To be eligible to set an ILS World Record in relay events teams must meet the relevant Open and/or Youth national or interclub eligibility requirements (as appropriate) as defined in the ILS LWC Handbook.
- F. World records may be established and held by members of an ILS Full, Associate or Corresponding Member Organisation and be eligible to compete at the sanctioned or ILS competition.
- Note:** An ILS Full Member Federation must provide permission for members of an Associate or Corresponding Federation to compete at an ILS LWC, regional Championships etc., and at a sanctioned ILS competition. Without this permission the ILS will not recognise a world record.
- G. Youth competitors may establish Youth or Open world records regardless of the category in which they are competing at the time (i.e., Youth or Open competition).
- H. Masters' competitors may establish both a Master and/or Open world records regardless of the age category in which they are competing (i.e., participating in a Masters or Open age event). However, a Masters competitor may only claim the masters record for their designated masters age group.
- I. All records achieved during Masters, Interclub or National Teams Lifesaving World Championships, World Games or ILS regional Championships shall be automatically approved (and without a doping test).
- Note 1:** It is recommended that a World Record application form is completed to ensure that all records created at a LWC are recorded. The Chief Steward/Head Scorer should assist with this process.
- Note 2:** Masters world records set at any ILS LWC, World Games, or ILS regional Championships or ILS sanctioned competition shall be recognised without a negative doping test certificate.
- J. Records at the other competitions shall be approved subject to the following conditions:
- The competition must have been sanctioned by the ILS.
  - All records must be achieved in competitions held in public and announced to the public (and to ILS headquarters) by advertisement at least three days before competition.
  - The facility (including event-specific) standards and equipment specifications must be certified by a surveyor or other qualified Official appointed or approved by the ILS Management Committee (for world Championships) or the ILS Member Organisation for ILS-sanctioned competitions in their jurisdiction.
  - The ILS will accept world records only when times are recorded by automatic officiating equipment.
- K. Times which are equal to 1/100 of a second will be recognised as equal records, and competitors achieving these equal times will be called "Joint Holders."
- L. Only the time of the winner of a race may be submitted for a world record. However, if the race contains competitors of different age groups, times may be submitted for a world record by the leading competitor in an age division within the one race.
- M. In the event of a tie in a record-setting race, each competitor who tied shall be considered a winner and will jointly hold the world record.

- N. In the event of a record being set in one race and subsequently broken in a later race(s), the earlier and later times will be recognised as world records in chronological order.
- O. Applications for world records must be made by the responsible authority of the Organising Committee of the competition using the Official ILS Record Application Form (see end of this section and also available online at [www.ilsf.org](http://www.ilsf.org)) and signed by the ILS-recognised Chief Referee certifying that all regulations have been observed including a negative doping test certification. The application shall be forwarded to the ILS Custodian of Records within 28 days of the conclusion of the competition.
- P. Upon receipt of the ILS Record Application, and upon satisfaction that the information contained in the application is accurate, the ILS Custodian of Records will recommend that the ILS Secretary General declare and publish the world record and provide a world record certificate to the competitor signed by the ILS President and ILS Secretary General.
- Q. Doping Control and World Records
- For all world records set at Interclub or National Teams Lifesaving World Championships, World Games, or ILS regional Championships where there is in place a system of targeted and random tests in accordance with the ILS anti-doping rules, no negative doping test certificate is required.
  - At an ILS sanctioned event a youth or open competitor establishing or equalling an ILS world record shall submit to “doping control” following a race and a negative doping test certificate must be provided along with the ILS record application to recognise a world record established at an ILS sanctioned competition. If the ILS has not sanctioned the competition, the record will not be recognised.
  - If no doping control is conducted at the competition, the competitor(s) shall submit to doping control no later than 24 hours after the race.
  - Masters’ world records set at any ILS LWC, World Games, or ILS regional Championships or ILS sanctioned competition shall be recognised without a negative doping test certificate.
- R. If the world record application is not accepted, and the decision appealed, it shall be referred to the ILS Sport Commission for consideration.

## **6. OFFICIAL START AND COMPLETION OF COMPETITION**

- A. A competition is deemed to begin when a call for entry registration is Officially issued by the competition Organisers.
- B. The Official conclusion of a competition is 20 minutes following the completion of the last competition event. However, issues under protest, appeal or disciplinary review shall continue to final resolution which shall be deemed to fall within the Official competition time.

## **7. PREVAILING CONDITIONS**

- A. Competitors acknowledge and accept that open water competitions can be affected by environmental conditions beyond the control of Organisers (e.g., water or beach conditions, or inclement weather) and that competitors are subject to luck of the prevailing conditions.
- B. No protest or appeal will be entertained when an incident is caused by the prevailing conditions. The Chief Referee and/or relevant Official(s) have absolute discretion in determining whether an incident has been caused by the luck of the prevailing conditions.

## **8. VIDEO RECORDING DEVICES**

- A. Mounted on craft
- Video cameras may be mounted on boards, surf skis, surf boats and inflatable rescue craft (IRB) as long as such devices conform to the requirements specified in Section 8, Facility and Equipment Standards and Scrutineering Procedures.
- B. Attached to competitors
- Except for Surf boat Sweeps and IRB drivers, video cameras may not be worn or otherwise attached to a competitor from start to finish of a race.

## **9. COMMUNICATION DEVICES IN COMPETITION**

Competitors in a race are not permitted to use electronic communication devices from the beginning to the completion of the race.

## 10. COMPETITION ATTIRE

Competitors shall wear costumes, clothing or dress approved by the ILS. A competitor shall not be permitted to take part in any competition if, in the opinion of the Chief Referee, the competitor is not properly attired.

For standards related to swimwear, see Section 8.

The Chief Referee has the authority to exclude any competitor whose swimwear does not comply with the following:

### A. Swimwear:

The swimsuits worn by competitors shall comply with the ILS swimsuit standard defined in Section 8, and:

- Should not offend morality and good taste (in particular, but not exclusively, the transparency of the material and/or the cut of the suit).
- Not carry any symbol which may be considered offensive.
- Comply with the commercial identification policy.
- Both men and women competitors may wear "modesty" swimwear made of a textile woven fabric under their swimsuit, provided that no competitive advantage is gained. Any modesty swimwear shall be restricted to the short style for men and the two-piece style top and/or bottom for women.
- Upon application for religious and/or cultural reasons, the ILS shall consider the wearing of (non-body shaping) textile swimwear that covers a greater part of the body provided that such swimwear does not provide a competitive advantage.

### B. Protective clothing:

- Except for swimmers in pool and ocean events, other protective clothing (e.g., shorts, vests, t-shirts, wetsuits, etc.) may be worn by competitors in both individual and team events unless otherwise prescribed by these rules or the event organising authority. Vests, t-shirts and shorts, long leg tights, leg stockings and/or compression garments are only permitted to be worn in the pool line throw event and in non-swimming ocean/beach individual events or non-swimming legs of ocean/beach team events.

**Note:** Board Paddlers may also wear protective clothing except that sleeves are not permitted on the arms of competitors unless climatic conditions dictate and are approved by the Chief Referee or their designate.

### C. Flotation vests:

- Must be worn in IRB events and may be worn in board, surf ski, surf boat events and in non-swimming legs of the Oceanman/Oceanwoman individual and relay events.

### D. In surfboat events:

- The Sweep oarsman may wear apparel (including wetsuit and booties) as conditions warrant. The specifications for wetsuits (S8-4.8) shall not apply.

### E. In IRB events:

- Competitors may wear apparel including wetsuits, booties, gloves, and hoods, except in the IRB Rescue Tube race where crewpersons and patients (victims) are not permitted to wear gloves. The specifications for wetsuits (S8-4.8) shall not apply.

### F. Competition caps and helmets:

- Competition caps and/or helmets must be worn at the start of a race by competitors in all events to assist with safety, identification and judging of competitors.
- All individual competitors and competitors from the same team shall wear their Official team swim caps and/or helmets in each event. Competitor names on caps/helmets are permitted.  
**Note 1:** Where a team has more than one official cap members of each team should wear matching caps.  
**Note 2:** In addition, if there is more one team from the same entity in an event, the teams should be differentiated by some means e.g. distinguishing numbers or letters on the caps or marked on the upper arms (e.g. A, or B, 1, or 2, etc.).

•

- In ocean events, caps – securely fastened under the chin – must be worn on the competitors' heads at the start of each event and at the start of each leg in team events.

- In pool events and in the Simulated Emergency Response Competition, the ocean event caps, or rubber or silicone caps must be worn on competitors' heads at the start of each event and at the start of each leg in team events.
- Competitors may also wear rubber or silicone caps under ocean competition caps.
- The wearing of aquatic safety helmets is compulsory in surf boat events (unless otherwise optional – refer Section 6 for details) and IRB events and is optional in surfboard and surf ski events. The conditions for the wearing of helmets are the same as swim caps.
- Note: For helmet standards and colours, see Section 8).
- A competitor/team shall not be disqualified if the cap or helmet is displaced or lost after the start of an event in any competition (including pool, SERC, ocean and beach, surf boat, and IRB events) provided that Officials can identify that the competitor/team correctly completed the race. **Note:** Competitors should continue to wear their identifying caps or helmets (to assist in accurate recording of placings) until the Official in charge of the finish advises caps or helmets may be removed.

G. Vests:

- Competitors in pool events are not required to wear distinctive high-visibility vests unless otherwise determined by competition Organisers.
- For safety and identification, competitors and handlers entering open water for competition or training beyond knee depth shall be required to wear distinctive high-visibility vests as determined by the ILS competition Organiser. High-visibility vests are mandatory in events staged in ocean or open water.
- In ocean events, the vests worn by swimmers must be high-visibility, sleeveless singlets extending from the neck to the midriff region. Competitors who are not swimming (e.g., paddlers, handlers) are permitted to wear different style high-visibility vests (e.g., sleeved rash vests).
- These vests must be worn over the top of swimwear and, where relevant, personal flotation devices, protective clothing, and/or wet suits. Refer to 2.10.8 b) for IRB events.
- Competitors may also be required to wear distinctive coloured vests or bibs to assist with judging of finishes. Such vests or bibs will be supplied by the ILS.
- Even when ILS competition Organisers supply high-visibility vests, competitors may be permitted to wear their own vests only if:
  - The vest colour is the same as that prescribed by the Organisers.
  - The vests meet the requirements of ILS competition sponsorship requirements.
  - The vests are approved by the ILS competition management committee.
- Should Organisers prescribe a different coloured vest to be worn in different events or areas, or by different genders to assist with safety, identification, and or/judging, they will be supplied by the ILS. In such circumstances, club, or team high visibility vests (or caps) do not need to be worn under the prescribed coloured vest (or cap).

H. Lifejackets and Personal Flotation Devices (PFDs):

- Personal Flotation Devices may be worn in board, surf ski, and surf boat events, and in non-swimming legs of the Oceanman/Oceanwoman individual and relay events.
- In IRB events, the wearing of approved PFDs is compulsory for drivers, crew and patients in both training and competition. It is not required for high visibility safety vests to be worn over the top of PFDs.
- For PFD standards, see Section 8.

I. Eyewear:

- Swim goggles may be worn except in Simulated Emergency Response Competition.
- Sunglasses or optical glasses may be worn in all events provided that any eye protection or optical glasses worn must be suitably designed for that event.

J. Footwear:

- Competitors shall not wear footwear in competition events unless otherwise specified in the event description or at the discretion of the Chief Referee based on conditions.
- Manikin handlers may wear footwear in pool events.
- Competitors may wear footwear in the 1km and 2km Beach Runs and the 3 x 1km Beach Run Relay.

K. Wetsuits:

- Wetsuits shall be permitted in ocean events only in water temperature of less than 16°C. The Chief Referee may authorise the wearing of wetsuits dependent upon weather, water, or other marine conditions. In such circumstances it is recommended that wetsuits be worn by competitors in water events or where there is a risk of immersion.
- The Chief Referee in consultation with the Safety Officer and Competition Committee may allow the wearing of wetsuits in water temperatures greater than 16 degrees particularly where weather and/or wind chill factors are considered a risk for participant hypothermia. In such circumstances it is recommended that wetsuits be worn by competitors in water events or where there is a risk of immersion.
- Competitors may not wear more than one wet suit or marine stinger suit.
- Wetsuits must be worn in water temperatures of less than 16°C.
- Wetsuits may be worn by IRB competitors, surf boat Sweeps in any conditions.
- No events with swimming shall take place in water temperature less than 13.0 degrees Celsius.
- Wetsuits must conform to ILS standards outlined in Section 8.

L. Marine Stinger Suits:

- The Chief Referee may authorise the wearing of marine stinger suits dependent upon marine conditions. In such circumstances it is recommended that marine stinger wetsuits be worn by competitors in water events where there is a risk of injury.
- Marine Stinger Suits are to be approved by the organising authority for a competition.

## 11. AGE CATEGORIES

### 11.1 Determining Age Categories

The ILS follows the IOC guidelines for determining the age of competitors in its events such as the Lifesaving World Championships. A competitor's age and eligibility age group (s) are determined by how old he or she is as of 31<sup>st</sup> December of the year in which they are participating in the competition.

Examples are:

Open Competition	
Eligible:	Competitors who turn 16 years of age on or before 31 <sup>st</sup> December in the year of the competition. There is no maximum age.
Not eligible:	Competitors who are younger than 15 or turn 15 in the year of competition

Youth Competition	
Eligible:	Competitors who turn 15,16,17 and 18 years of age on or before 31 <sup>st</sup> December in the year of the competition.
Not eligible:	Competitors who are younger than 14 or who turn 19 in the year of competition

Masters Competition	
Eligible:	Competitors who turn 30 years of age on or before 31 <sup>st</sup> December in the year of the competition. There is no maximum age.
Not eligible:	Competitors who turn 29 in the year of the competition.

ILS Masters individual events may be conducted in five-year age groups from 30 years of age to over 75 years of age e.g., 30 - 34, 65 - 69, 75 years plus.

ILS Masters two-person team events may be conducted in five-year age groups from 30 years of age to over 75 years of age e.g., 30 - 34, 65 - 69, and 75 years plus based on the age of the youngest team member.

ILS Masters Competition three-person team events may be conducted in age groups 90 -109, 110 - 129, 130 - 149, 150 - 169 and 170 years plus based on the total ages of the three team members.

ILS Masters Competition four-person team events are 120 - 139, 140 - 169, 170 - 199, 200 - 220 - 229, and 230 years plus based on the total ages of the four team members.

ILS Masters Competition Surf Boat age groups may be conducted in seven age groups 120 - 139, 140 - 159, 160 - 179, 180 -199, 200 - 219, 220 - 259, and 260 years plus based on the total ages of the four rowers (but not the Sweep) – refer Section 6.

Federations may decide which age groups to conduct Masters Competition dependent on their needs.

<b>19 Years Surf Boats</b>	
Eligible:	Competitors who turn 15, 16, 17, 18, or 19 years of age on or before 31 <sup>st</sup> December in the year of the competition.
Not eligible:	Competitors who turn 14 or 20 in the year of the competition.

<b>23 Years Surf Boats</b>	
Eligible:	Competitors who turn 15, 16, 17, 18, 19, 20, 21, 22 or 23 years of age on or before 31 <sup>st</sup> December in the year of the competition.
Not eligible:	Competitors who turn 14 or 24 in the year of the competition.

<b>Open and Reserve Surf Boats</b>	
Eligible:	Competitors who turn 15, years of age on or before 31 <sup>st</sup> December in the year of the competition. There is no maximum age.
Not eligible:	Competitors who turn 14 in the year of the competition.

<b>Inflatable Rescue Boats</b>	
<b>IRB Drivers:</b>	
<b>Note:</b>	ILS Member Federations may require participants in IRB events to hold specific qualifications. ILS member Federation should only endorse the entries of members qualified and certified proficient to participate in IRB competition.
Eligible:	Competitors who turn 18 years of age on or before 31 <sup>st</sup> December in the year of competition. There is no maximum age. Competitors who turn 18 years of age on or before 31 <sup>st</sup> December in the year of competition. There is no maximum age.
Not eligible:	Competitors who are younger than 17 in the year of competition and those who are not certified by their Federation to drive/operate IRBs and those who are unlicensed drivers.
<b>Note:</b>	In most countries drivers are required to be licensed under statutory arrangements to operate a maritime vessel. The Organising Committee should advise local requirements as part of entry requirements.
<b>IRB Crewpersons:</b>	
Eligible:	Competitors who turn 16 years of age on or before 31 <sup>st</sup> December in the year of competition and are certified by their Federation as proficient to be patients and/or to crew IRBs. There is no maximum age.
Not eligible:	Competitors who are younger than 15 in the year of competition and those who are not certified by their Federation to crew IRBs.
<b>IRB Patients and Handlers:</b>	
Eligible:	Competitors who turn 15 years of age on or before 31 <sup>st</sup> December in the year of competition and are certified by their Federation to be proficient to be patients and/or to crew IRBs. There is no maximum age.
Not eligible:	Competitors who turn 14 in the year of the competition and those who are not certified by their Federation to be patients and/or to crew IRBs.

## 12 COMPETITORS WITH A DISABILITY

- A. With the desire to provide opportunities for all eligible competitors, accommodations may be made for a competitor with a permanent limiting disability to participate in an event/competition.
- B. Upon application to the Competition Committee for a competition, an allowance may be considered but only if there is no disadvantage to other competitors in the event. This allowance may include but is not limited to starts, finishes, equipment modification, rules etc.
- C. The decision of the Competition Committee on such matters shall be final and not subject to protest.

**Note 1:** This section is not to assist competitors who have suffered an injury. The section is intended to assist members with a permanent limiting disability to participate in ILS competitions.

**Note 2:** This section is also not intended in the normal course to assist competitors with say, replacement knees or hips and/or muscle and/or joint injuries and/or dilapidations etc. by allowing runners in events. Such competitors must accept that their capacity may be limited by life events but does not qualify for allowances.

**Note 3:** It is clarified that an undertaking by a team or individual that a runner will not overtake another competitor or simply maintain their relative place in a race is not regarded as eliminating a disadvantage to other competitors in the event.

**Note 4:** The ILS may also issue discreet rules and conduct inclusive events for competitors with a permanent limiting disability.

## 13. TRANSGENDER GUIDELINES

The ILS seeks to act at all times in the interests of its members and has developed appropriate policies and guidelines to achieve appropriate outcomes. This includes providing a framework to encourage participation in competitive lifesaving activities and ensuring that all such activities are conducted on a fair and equal basis.

To this end ILS has in place a policy for transgender athletes wishing to compete in ILS and member federation competitions. This policy has been adopted from the IOC guidelines.

Refer to the [ILS Website](#) for the ILS Trans Gender Policy.

## 14. INTERCLUB, NATIONAL, AND INTERNATIONAL MEMBER COMPETITION TRANSFERS

- A. It is a Federation's responsibility to manage their members' interclub competition transfer arrangements.
- B. Competitors must apply to transfer to a foreign club. For the application to succeed, competitors require approval from their home club, region, and national organisations:
  - Applicants shall seek clearance from their current club and forward this clearance to their regional (if any) and national organisation for endorsement.
  - The national organization shall advise the applicant of its decision and forward its approval, if granted, to the national organization of the applicant's new club.
  - National organisations shall not unreasonably withhold transfer approval.
  - The ILS Sport Commission shall resolve disputes over international transfers in consultation with the disputing parties. The Sport Commission's decision shall be final.

**Note:** The club international transfer rules (above) do not apply to National Teams Championships.

## 15. ANTI DOPING

### 15.1 Drug policy and process

ILS shares the World Anti-Doping Agency (WADA) vision of a world where athletes can participate in a doping-free sporting environment.

ILS has committed itself and its member federations/organisations to adhere to the WADA standards and seeks to provide a clean, safe, and fair sporting environment.

To this end ILS provides comprehensive [anti-doping information](#) to its members via its website. ILS also has in place [anti-doping rules](#) that are consistent with the World Anti-Doping Agency (WADA) standards.

A key principle of WADA's World Anti-Doping Code International Standard for Education (ISE) is that the first encounter with clean sport and anti-doping should be for athletes to be educated before being tested.

This principle is reflected in the ILS [Education Plan](#) that applies from club to international level participants including athletes of all ages, coaches, managers, medical professionals, carers and Officials.

Please note that the delivery of Anti-doping requirements including education is the responsibility of ILS National Lifesaving Federations/Organisations (NLFOS) and their National Anti-Doping Organisation (NADO) should be their point of contact for Anti-Doping operational matters.

There is the possibility of drug testing at all ILS world Championships, ILS regional Championships and multi-sport Games where Lifesaving is included, and ILS sanctioned, and other events conducted by NLFOS.

The ILS recognises that a host country may have laws or legal requirements in addition to the ILS drug policy. Competitors must be informed of such requirements as part of event registration procedures.

Please note that Out of Competition Anti-Doping tests can also occur at any time for the identified elite ILS athletes in the ILS Testing Pool (as may also occur for athletes of ILS NLFOS through their NADOs). A violation of the ILS Anti-Doping Rules leads to disqualification of an athlete's individual results including forfeiture of points, medals, and prizes in individual events. In a team event, if a member of a team violates the ILS Anti-Doping Rules, the entire team shall be disqualified from that event with the attendant loss of points, medals, and prizes.

## 15.2 Doping control event definitions

For purposes of doping control, the following definitions shall apply:

### A. Individual events:

- An individual event shall be contested by a single competitor. An individual may be assisted by handlers (e.g., Oceanman/Oceanwoman, Super Lifesaver). There can be no substitution of individuals in an event or between rounds. If a competitor is disqualified for a breach of the rules, doping offence, etc., the competitor loses all standing in the event being contested.

### B. Team events:

- A team event is contested by more than one competitor from the same National Team, club or lifesaving unit who complete an event or race together as a discrete unit (e.g., SERC) or separately (e.g., relay events). Team members may be substituted between rounds, but there shall be no substitution of competitors while a race is being conducted. If one or more competitors are disqualified for a breach of the rules, doping offence, etc., the entire team loses all standing in the event being contested.

### C. Team medal count or point score:

- To recognise overall winning teams at a competition a medal count tally (based on individual and team event first placings etc.) or a point score may be conducted. The organising authority shall advise the basis details of any team medal count or point score. If one or more competitors are disqualified for a breach of the rules in an individual or team event, then no medals or points are awarded to those particular competitors or teams, but the team may retain standing in the medal count or point score unless otherwise determined by the organising authority.

**Note:** The definitions above for “individual events” and “team events” are the same as the definitions of “individual sport” and “team sport” used in the ILS Anti-Doping Rules. The term “crew” has the same meaning and effect as “team” in relation to ILS competition.

## 16. CODE OF CONDUCT

### 16.1 Code of conduct for competitors, technical Officials, and members

The ILS competitions are high profile public events. The ILS expects all competitors, Officials, and members to co-operate to ensure a positive public image. Behaviour likely to cause embarrassment or damage to the image of the ILS or lifesaving competition will be referred to the Disciplinary Committee. Penalties may include expulsion of individuals or teams from the competition.

The ILS expects the highest standard of conduct of its competitors, Officials, and members. These expectations are reflected in the rules for competition in the ILS constitution and this rule book.

For the purpose of applying the code of conduct, the definition of a ‘team’ includes the competitors, coaches, managers, chaperones, assistants, member spectators, etc., travelling with the team. Violations of this code may result in individual and/or team disqualification and/or expulsion from the competition.

### 16.2 Fair-play code for lifesaving competitions

It is important that competition, especially world Championships, be conducted in a spirit of goodwill and sportsmanship.

Competitors are required to abide by and compete within the rules. Any breach of the rules will be reported to the Chief Referee who may initiate action as described in S2-16 Misconduct.

Team members represent their country, their organisation, their club, their sponsors, and the ILS. As such, team members shall at all times conduct themselves in a proper and civil manner during the Championships and related activities including social functions.

Unbecoming conduct by a team or its supporters is a serious offence and will be dealt with as such. Any action by a team which attempts to disrupt or interfere with another team is a serious offence and will be dealt with as such.

The general conduct of all participants will be measured by the following ILS code of fair play:

- A. The ILS will
- Promote and encourage fair play through its members.
  - Impress upon competitors, coaches, technical Officials, and administrators the need to maintain the highest standards of sportsmanship and good behaviour in lifesaving sport.
  - Ensure that its rules are fair, clearly understood by competitors, coaches, technical Officials, and administrators, and properly enforced.
  - Make every effort to ensure that its rules are applied consistently and impartially.
  - Treat all members equally, regardless of their sex, gender identity, intersex status, sexual orientation, age, ability, race, or physical characteristics, etc.
  - Make all reasonable provision to accommodate competitors with disabilities provided that there is no competitive disadvantage to other competitors in the event being contested.
- B. The ILS technical Officials will:
- Abide by the rules and the spirit of the competition.
  - Be honest, fair, and ethical in dealing with others.
  - Be professional in appearance, action, and language.
  - Resolve conflicts fairly and promptly through established procedures.
  - Maintain strict impartiality.
  - Maintain a safe environment for others.
  - Be respectful and considerate of others.
  - Be a positive role model.
- C. Competitors will:
- Abide by the rules and the spirit of the competition.
  - Treat Officials with respect and accept the decisions of Referees and Judges without question or complaint.
  - Never consider cheating and in particular, not attempt to improve their individual performance by the use of drugs.
  - Exercise reasonable self-control at all times.
  - Accept success and failure, victory, and defeat, with grace and magnanimity.
  - Treat their fellow competitors and team members with respect, both in and outside the Competition Arena.
- D. Team managers and coaches will:
- Insist that competitors understand and abide by the principles of fair play.
  - Never countenance the use of drugs by competitors.
  - Never employ methods or practices that could involve risks, however slight, to the long-term health or physical development of their competitors.
  - Not attempt to manipulate the rules in order to take advantage of their competitors or their opponents.
  - Respect the regulations and authority of the ILS and its member organisations and not attempt to avoid or circumvent these regulations.
  - Recognise the special role that they have to play in the ILS and set a good example of sportsmanship and good behaviour at all times.
  - Respect the rights of other teams and never deliberately act in a manner intended to be to the detriment of another team.
  - Respect the rights of competitors, coaches, technical Officials and not exploit or deliberately act in a manner detrimental to them.
  - Not endeavour to influence the result of a competition by any action not strictly within the rules and regulations or within the fundamental precepts of fair play.

- E. Delegates, media representatives, supporters and spectators will:
- Respect the authority and regulations of the ILS and not attempt to avoid or circumvent them.
  - Accept the authority of technical Officials.
  - Abide by the spirit of the competitions.
  - Exercise reasonable self-control and display good behaviour at all times.
  - Be respectful and considerate in interactions with others.
  - Acknowledge the performance of all involved in the competition with grace and magnanimity.

## 17. MISCONDUCT

### 17.1 Conduct and discipline generally

The ILS, either by pre-determined publicised penalties or by adopting the decision of a Disciplinary Committee, may, at its discretion, issue penalties to individual competitors, clubs, or national teams.

### 17.2 Competing unfairly

- A. Competitors or teams who are deemed to have competed unfairly may be disqualified from an event or expelled from the Championships. The Chief Referee may refer the competitor, team to the Disciplinary Committee for consideration of further penalty. Examples of competing unfairly include:
- Committing a doping or doping-related infraction.
  - Impersonating another competitor.
  - Competing twice in the same individual event.
  - Competing twice in the same event in different teams.
  - Purposely interfering with a course to gain an advantage.
  - Competing without entry.
  - Competing for another club or nation without federation clearance.
  - Attempt to defeat the ballot or draw for events or positions.
  - Competing using equipment that does not meet ILS specifications.
  - Competing contrary to the specific direction of the Chief Referee or designated Official.
  - Jostling or obstructing other competitors or handlers so as to impede their progress. Note: See also the Beach Flags rules that provide for *elimination* from an event in such circumstances.
  - Receiving physical or material outside assistance (other than verbal or other direction except where specifically excluded by the rules of the event).
  - Participating contrary to the spirit of the competition (as described in the code of fair play).
- B. The Chief Referee and/or the relevant technical Official(s) shall have absolute discretion in determining whether a competitor, team or handler has competed unfairly.
- C. The ILS may, in its absolute discretion, investigate and take action on any matter of “competing unfairly” prior to, during or following competition. This includes, but is not limited to, the return of medals and referral to the Disciplinary Committee.

### 17.3 Serious discipline offence

- A. If a competitor or team commits what could be a serious discipline offence, they should immediately contact the Organising Committee and detail the circumstances. Failure to report a possible violation is itself an offence against ILS rules.
- B. Allegations of a serious discipline offence shall be referred to the Disciplinary Committee.
- C. If the Chief Referee disqualifies a competitor or team for a serious offence in competition, the Chief Referee may also choose to make a report to the Disciplinary Committee which may decide to apply a further penalty against the competitor or team and its members.

### 17.4 Disciplinary Committee

- A. The Organising Committee shall appoint a Disciplinary Committee consisting of no less than three members.
- B. The host Organising Committee shall supply the Disciplinary Committee with the name, contact address and phone number at the competition site of the manager of every participating team.
- C. The Disciplinary Committee shall inquire into any written complaint of misconduct, or any matter referred to it by the Appeals Committee or Chief Referee.

- 
- D. The committee may also initiate an inquiry to determine if an offence has been committed and make a complaint if appropriate. The committee may then proceed as if another person had made the complaint.
- E. The Committee may assign appropriate penalties including removal from or disqualification from the Championships and forfeiture of titles or trophies.
- F. The Committee shall report in writing on its inquiries and decisions to the ILS Secretary General.
- G. Complaints must be received in writing, or the complainant must be prepared to attend a meeting, hearing, or inquiry of the Committee as and when required.
- H. The member or members against whom the complaint is made shall be entitled to be present at every hearing accompanied by the team manager.
- I. All persons involved in a disciplinary hearing or enquiry or an Appeals Committee hearing, must abide by and strictly observe the ILS Code of Conduct set out in this Section. In particular, but without limitation, all persons involved in such hearings or enquires must:
- Be honest, fair, and ethical.
  - Be respectful and considerate of others.
  - Exercise reasonable self-control at all times.
  - Be truthful and treat all persons involved in good faith and with courtesy and respect.
- J. Inquiry guidelines:
- Formal rules of evidence will not apply to the hearing or enquiry, but all persons involved must be truthful and act in good faith.
  - The complaint or reference to the committee shall be read to the competitor(s) or to the team(s) representative(s).
  - The evidence of the complainant shall be presented.
  - The evidence of the team member(s) against whom the complaint has been made shall be presented.
  - Each witness shall be subject to examination by the party (if any) on whose behalf the witness is called and then to cross-examination by the opposing party or parties. The party calling the witness shall have the right to re-examination, but no other examination shall be allowed except by leave of the committee.
  - Hearsay and irrelevant evidence shall not be admitted.
  - Witnesses other than the party charged shall remain out of hearing of the inquiry until called upon to give evidence.

### **17.5 Notification of Findings**

- A. The committee shall make its decisions in camera. If the complaint is proved, the committee may impose a penalty. Notice of the finding and the penalty shall be given forthwith in writing by the chair of the committee to the team member concerned, to their team or club, and to the country to which the team or club is affiliated.
- B. The finding and penalty (if any) shall be effective forthwith.

## **18. DISQUALIFICATIONS AND “DID NOT FINISH” CLASSIFICATIONS**

Competitors or teams may be disqualified from an event or from the entire competition. Where a competitor is disqualified for any reason, in a heat or a final, the place he or she would have held shall be awarded to the competitor who finished next and all lower placing competitors shall be advanced one place. (See the Beach Flags and Oceanman/Oceanwoman and Ocean M Eliminator event variations for specific placings and points allocations for events conducted in an elimination format. See also Surf Boat Events for “Round Robin” points allocations, disqualifications, elimination and did not finish classifications.)

Where a competitor is disqualified for any reason, the final event results shall not include a place or time for the competitor.

Competitors may protest or appeal certain disqualifications as detailed in this Rulebook.

- A. Did not finish (DNF):
- Where a competitor does not finish an event for any reason, in a heat or a final, the place he or she would have held shall be awarded to the competitor who finished next and all lower placing competitors shall be advanced one place.

- Where a competitor does not finish an event, the event results shall not include a place or time for the competitor.
- B. Disqualification from competition:  
Examples of behaviour which may result in disqualification of individuals or teams from the competition, include:
- Refusing to fulfil the conditions of entry.
  - Breach of the ILS code of conduct or rules.
  - The impersonation or use of unauthorised competitors.
  - Activities resulting in wilful damage to the venue sites, accommodation sites or the property of others.
  - Abuse of technical Officials.
- C. Disqualification from events:  
Examples of behaviour, which may result in disqualification of individuals or teams from an event, include:
- Being absent at the start of an event.
  - Infraction of the “General conditions” for events or infraction of event rules.
- D. Competitors shall be notified of their disqualification from an event by the Chief Referee or appropriate Judge, at the completion of the race. Competitors shall not leave the designated competition area until dismissed by the Chief Referee or appropriate technical Official.
- E. If an error by an Official causes a fault by a competitor, the fault by the competitor may be expunged at the Chief Referee’s discretion.

**Note:** Disqualification (DQ) codes are listed at the end of the relevant sections of the ILS Competition Rule Book.

## 19. PROTESTS AND APPEALS

The Organising Committee reserves the right to delete, alter or otherwise vary any rule, competition criteria, timetable, or other matter as it deems necessary. Every effort will be made to ensure that each team manager receives notice. Protests resulting from such Organising Committee decisions will not be entertained.

In addition, event courses and the competition area may change from the descriptions in this rule book if the Chief Referee deems it necessary and providing teams have been advised of the change before the start of that event.

A competitor or team manager may protest to a Chief Referee and subsequently dispute a Chief Referee’s decision in the manner prescribed below. See Protest/Appeal Form at the end of this section.

**Note:** Refer also to specific rules in this section for Beach Flag rules for protest and appeal processes.

### 19.1 Types of protests

Protests, which may lead to the imposition of penalties, fall broadly into the following categories:

- Protests arising from entry procedures or entry eligibility.
- Protests arising from scrutineering or equipment eligibility.
- Protests arising during participation in the competition and/or breaches of rules.

### 19.2 Lodging a protest

The conditions relating to the lodgement of protests shall be as follows:

- A. A start decision by the Starter or the Chief Referee (or their designate) is not subject to protest.
- B. A protest or appeal directly challenging a Finish Judge’s decision cannot be accepted. However, upon request, and at their absolute discretion, technical Officials may review their order of finish decisions.
- C. No protest shall be accepted against the actions of another competitor or team in the same event except where that competitor or team has suffered direct interference e.g., if a technical Official takes an action or no action against a competitor or team, another competitor or team cannot protest unless they are in the same race and there is direct interference involved.
- D. A protest against the conditions under which an event or race is to be conducted must be made verbally to the Chief Referee prior to the event or race. Before the start of the event or race, the Chief Referee or appointed technical Official shall inform the competitors in that event or race of such a protest.

- E. A protest by against a competitor or a team (refer also S2-19.2C.) or against a decision of an Official must be lodged verbally with the Chief Referee or their designate within 15 minutes of the posting of the result of the event or within 15 minutes of being notified verbally by the Chief Referee of the decision, whichever occurs first. Within 15minutes of the submission of the verbal protest, a protest written in English on the ILS Protest/Appeal Form or other acceptable form shall be lodged with the Chief Referee.

**Note:** The Chief Referee and/or the Appeals Panel may, at their discretion may extend these time limits provided that results have not been declared as final.

- F. Where a protest is lodged, the result of the event shall be withheld or not finalised until the protest is decided. If a protest is upheld, placings and trophies (where relevant or required) shall be varied according to the amended result.
- G. The result of the protest shall be noted on the protest form and the result forms.
- H. There shall be no protest fee.

### 19.3 Protests in Beach Flags

- A. In Beach Flags events a protest against an elimination must be lodged verbally before the next run through of an event or within 2 minutes of the completion of the round (whichever occurs first). If a Beach Flag elimination protest occurs the Chief Referee will immediately consider the protest without delay before proceeding with the event. There will be no Appeal permitted on Beach Flag elimination protest decisions of the Chief Referee.
- B. A Chief Referee is also authorised to refer a Beach Flag elimination protest directly to an on-beach Jury of Appeal Committee representative for decision on the basis of the processes and timings detailed above. No paperwork is required nor is a fee is payable if this occurs.
- C. A competitor is permitted to protest and/or appeal against a disqualification decision in Beach Flag events provided that correct processes are followed.

### 19.4 Adjudication of protests

The conditions relating to the adjudication of protests shall be:

- A. Immediately after the correct lodgement of a protest, the Chief Referee may adjudicate on the matter as provided for herein or refer the matter directly to the appeals committee convenor.
- Note:** There is no fee when protesting a decision or if the Chief Referee (or their designate) refers the protest directly to the Appeals Committee without first making a decision on the protest.
- B. Where the Chief Referee considers (in their absolute discretion) that a protest is frivolous, or not of a serious nature, they may choose not to accept the protest.
- C. Where the Chief Referee or the Area Referee or the Sectional Referee accepts the protest, they will adjudicate on the protest in such manner as they see fit having regard to the interests of the competitor making the protest, all other competitors, and all Officials in the event and also the conduct of the event itself.
- Note:** Should it be determined that there was a technical or an administrative error in recording either the disqualification or protest reference, the error can be corrected, and the protest or appeal proceed without prejudice.
- D. Where the Chief Referee adjudicates and dismisses the protest or refuses to accept a protest (on the basis it is regarded as frivolous), the decision may be appealed to the appeals committee. Such appeal must be lodged with the appeals committee convenor within 30minutes of the decision of the protest being advised to the competitor, accompanied by the appeal fee.
- Note:** The Chief Referee at their discretion may extend this time limits provided that results have not been declared as final.
- E. The assistance of video or other electronic equipment may be used to consider protests. However, the onus is on the protester to provide proof of authenticity and any clearly viewable evidence and viewing mechanisms at the time that the protest is heard.

**Note:** A minimum 9 inch/228mm (measured on the diagonal) tablet type device with high definition is generally considered to be the minimum size to properly adjudicate on a protest.

### 19.5 Appeals Committee and Appeal Panels

The structure and functions of the Competition Appeals Committee and Appeal Panels are as follows:

- A. An authority conducting a competition shall appoint a Competition Appeals Committee of no less than three persons to deal with all protests referred to it by the Chief Referee or their delegate under Clause 14.3.3(a) and all appeals by competitors under Clause 14.3.3(d).

**Note:** For larger competitions it is recommended that the relevant authority appoints a Competition Appeals Committee of sufficient persons to enable at least two Competition Appeal Panels to consider protests simultaneously.

- B. The authority shall also appoint a person of suitable experience and practical knowledge to act as Convenor of the Competition Appeals Committee and to appoint Panels.

**Note 1:** If particular expertise is required to consider a matter the Competition Appeals Committee Convenor may appoint additional members to sit on a Panel.

**Note 2:** Where the Appeals Panel considers that an appeal may be frivolous, or not of a serious nature, they may seek a brief submission from those appealing a decision whether they wish for the appeal to proceed.

- C. When considering a protest or appeal the Competition Appeals Panel may comprise a minimum two persons to receive and determine protests and appeals.
- D. A member of the Competition Appeals Panel who has made a decision which is the subject of an appeal cannot consider that appeal.
- E. After hearing all available and relevant evidence, the Competition Appeals Panel shall consider its decision in private.
- F. The procedure for the Competition Appeals Panel is similar to the Competition Disciplinary Committee procedures (see S2 - 17.4).
- G. In considering protests and appeals the Competition Appeals Panel shall allow all relevant parties the opportunity to state their respective case and bring forward any relevant evidence to the Competition Appeals Panel. The Competition Appeals Panel will determine in its discretion who is a relevant party for the purposes of this paragraph.
- H. The assistance of video or other electronic aids may be used to consider appeals. However, the onus is on the protestor to provide proof of authenticity, and any viewing mechanisms within 15 minutes of the appeal being lodged.
- Note:** An approximate minimum 9 inch tablet type device with high definition display is generally considered to be the minimum size to properly adjudicate on a protest (or appeal).
- I. The Competition Appeals Panel shall consider the protest or appeal and make a decision. It may uphold or dismiss a protest or appeal.
- Note:** The Appeals Panel may assist the Referee with advice, if requested, but it is the Chief Referee's responsibility to decide on the course to be followed if the decision of an Appeals Panel is to uphold a protest or appeal.
- J. The Competition Appeals Panel may, in exceptional circumstances, consider whether the breach was "material" to the outcome of an event when making its decision to uphold or dismiss an appeal.
- K. The Competition Appeals Panel will advise the competitor and relevant parties of its decision and of any penalty (if relevant or appropriate) imposed. Reasons for this decision may or may not be provided.
- Note:** If an appeal is upheld any appeal fee paid shall be returned.
- L. The decision of the Competition Appeals Panel is final and there is no right of appeal against that decision.
- M. The Competition Appeals Panel may refer serious breaches of any ILS rules (including any supplementary regulations) to the Competition Disciplinary Committee for further inquiry.



**PROTEST FORM**

**Part 1:** Protests must be lodged in accordance with the ILS Competition Rule Book and/or ILS Bulletins. Protests may arise from entry procedures or entry eligibility; from scrutineering or equipment eligibility; or during participation in the competition and/or breach of rules.

Competitor(s)/team lodging protest (please print):	
Event:	
Arena:	
Lane/Heat/Lock-up:	
Date/Time:	
I/We formally protest against:	
Competitor (signature):	
Team Manager (signature):	

For Official Use Only

	Position of Official	Time
Results of event announced at (determine exact time):		
Verbal protest received by:		
Protest form received by:		
Decision:	<input type="checkbox"/> Upheld (agree with protest) <input type="checkbox"/> Dismissed (rule against protest) <input type="checkbox"/> Referred to Appeals <input type="checkbox"/> Referred to Disciplinary	
Remarks:		

Chief Referee (signature):	
Time protest decision advised to Competitor or Manager:	
Protestor signature acknowledges receipt of decision:	

Appeals Form on other side:

## APPEAL FORM

**Part 2:** Appeals must be lodged in accordance with the ILS Competition Rule Book.

Decisions of the Appeals Committee are final.

Basis or explanation for appeal:

--

For Official Use Only

	Position of Official:	Time:
Verbal appeal received by:		
Appeal form received by:		
Appeal fee received by:		
Appeal fee returned (if applicable):		
Appeal Chair name:		
Decision:	<input type="checkbox"/> Upheld (agree with protest) <input type="checkbox"/> Dismissed (rule against protest)	
Appeal Chair (signature):		
Time appeal decision advised to Competitor or Manager:		
Appellant's signature acknowledges receipt of decision:		
Remarks:		

**WORLD RECORD APPLICATION FORM**

What	Reply		
Type of Record			
Record			
Name of the ILS Sanctioned Competition Please add the Sanctioning Document			
Event			
Gender	<input type="checkbox"/> Man <input type="checkbox"/> Woman <input type="checkbox"/> Mixed		
Age Group	<input type="checkbox"/> Open <input type="checkbox"/> Youth <input type="checkbox"/> Masters Age Group:		
Family Name of the Competitor			
First Name(s) of the Competitor			
Date of Birth (Year/Month/Day)	Year:	Month:	Day:
Name of the Team			
Names of the Relay Team Members (names in order of competing)	Family Name	First Name	Date of Birth Y/M/D
1.			
2.			
3.			
4.			
Country			
Member Organisation			
Record claimed (0'00"00 minutes) Please add the Official result			
Date of Race	Year:	Month:	Day:
Time of Race (24h scale)			
Venue: Country			
Venue: City			
Chief Referee Name			
Chief Referee Signature			
Date			
Doping Control			
External Sample Code Please add the certificate			

**Note 1:** The ILS shall recognise Youth, Open and Masters men's and women's individual world records in all pool events identified in the ILS Competition Rule Book. This includes the 200m Obstacles for Masters competitors. It does not include the 100M obstacle event for Youth and Open competitors and mixed or single gender events in team categories except were conducted in those gender categories at an ILS LWC.

**Note 2:** Masters world records set at any ILS LWC, World Games or ILS regional Championships, ILS sanctioned competition shall be recognised without a negative doping test certificate.

An interactive version of this form is available online at [www.ilsf.org](http://www.ilsf.org).

The completed form must be sent to the ILS Custodian of Records via ILS Headquarters at [hq@ilsf.org](mailto:hq@ilsf.org) or to the Sport Commission of the ILS Region in accordance with the record rules.

**COMPETITION ORGANISATIONAL STRUCTURE – SCHEMATIC DIAGRAM**

<b>LIFESAVING FEDERATION / AUTHORITY</b>				
<b>LOCAL ORGANISING COMMITTEE(LOC)</b>				
<b>COMPETITION COMMITTEE (CC)</b>				<b>SAFETY COMMITTEE</b>
<b>LOC Representatives</b>	<b>EVENT ORGANISATION Representatives</b>	<b>SAFETY &amp; EMERGENCY Representatives</b>	<b>ILS SPORT COMMISSION Representatives And Chief Referee(s)</b>	
Event Approvals Volunteers Competition Services Site Logistics Work Parties Transport Sustenance, Medals and Prizes Venue Manager(s) Etc.	Admin Registration Results Overall Programme Enquiries Etc.	Safety, Security and Contingency Plans Safety Operations Security Operations First Aid Patrols, Authorities Etc.	Chief Referees Technical Officials Appointments Briefings Event Timetables Officials Recognition Liaison Etc.	<b>APPEALS COMMITTEE</b>
				<b>DISCIPLINARY COMMITTEE</b>
<b>ATHLETES / TEAM MANAGERS / COACHES OTHER REGISTRATIONS</b>				



**World Water Safety**  
**INTERNATIONAL LIFE SAVING FEDERATION**

## **ILS COMPETITION RULE BOOK**

### **SECTION 3** **POOL EVENTS**

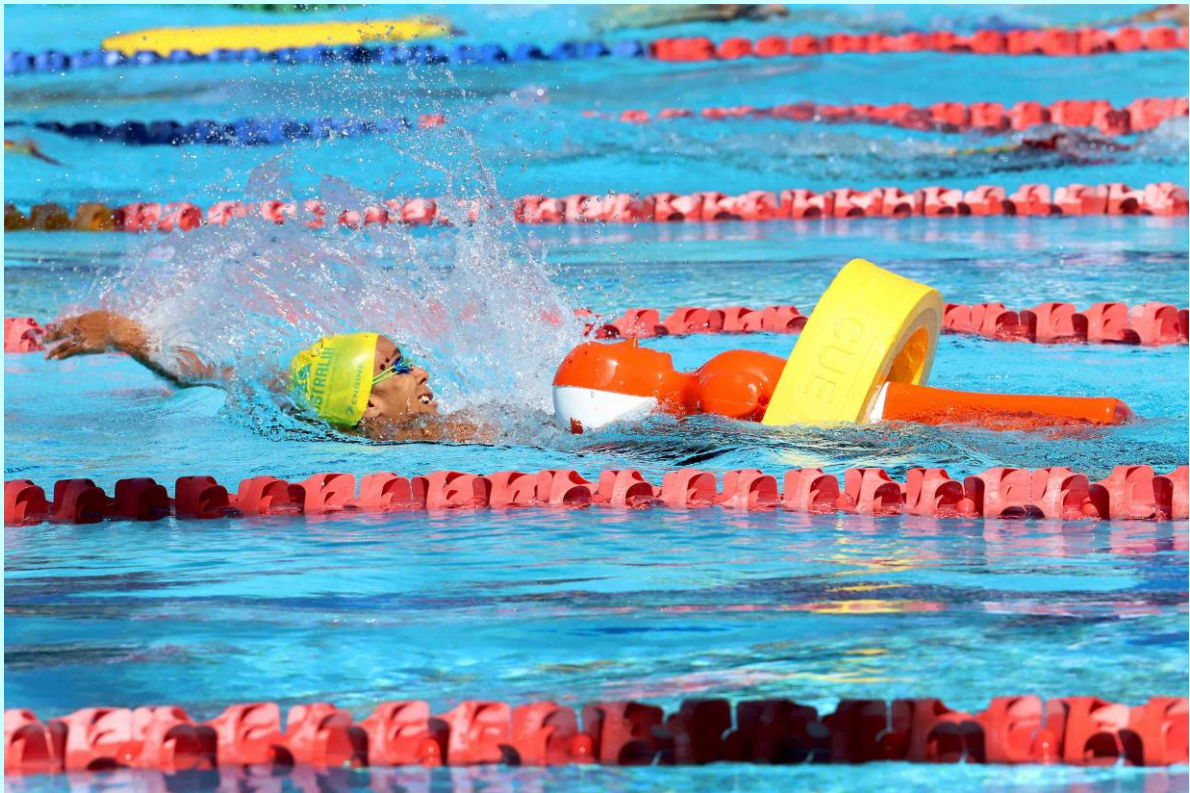

**2025 EDITION**  
**(Revised May 2026)**

## SECTION 3 POOL EVENTS

The following pool events are described in this section:

- Obstacle Swim – 200m and 100m
- Manikin Carry – 50m
- Rescue Medley – 100m
- Manikin Carry with Fins – 100m
- Manikin Tow with Fins – 100m
- Super Lifesaver – 200m
- Manikin Lifesaver Medley -100m
- Line Throw – 12.5m
- Manikin Relay – 4 x 25m
- Obstacle Relay – 4 x 50m
- Medley Relay – 4 x 50m
- Pool Lifesaver Relay Mixed – 4 x 50m
- Rescue Tow Relay – 4 x 50m

### 1. GENERAL CONDITIONS FOR POOL COMPETITION

Team Management and competitors are responsible for being familiar with the competition schedule, and with the rules and procedures governing events.

- A. Competitors may not be permitted to start in an event if they are late reporting to the Marshalling Area (DQ3).
- B. A competitor or team absent from the start of an event shall be disqualified (DQ4).
- C. Only competitors and Officials shall be allowed on the pool deck in the designated competition area. Competitors and Officials must leave the designated competition area when not competing or officiating.
- D. Unless specifically provided for in the rules, no artificial means of propulsion may be used in competition (e.g., hand webs, arm bands).
- E. The use of sticky, tacky or adhesive substances (liquid, solid or aerosol) on competitors' hands or feet, or applied to the surface of the manikin or rescue tube to improve grip, or to assist the competitor to push off the pool bottom, is not permitted in pool events (DQ7).

**Note:** The use of shampoo or soaps, or other similar biodegradable lubricants on fins and/or feet is permitted to assist competitors don fins.

- F. Body tape used for preventative, medical, therapeutic or kinesiology purposes is allowed at the discretion of the Chief Referee as long as it does not provide a competitive advantage to improve grip, grasping, or propulsion.

**Note:** The above means that, in general, tapes on the body (including limbs but not extremities) may be acceptable. Further, in general tape is not permitted: - on multiple fingers (two or more fingers taped together) as they may aid swimming and/or grip on a manikin: and - on a single finger, if it improves manikin/equipment grasping and manikin carry.

- G. Competitors shall not take assistance from the pool bottom except where specifically allowed (e.g., surfacing with a manikin, Obstacle Swim and Relay, 4 x 25m Manikin Relay, Manikin Tow, Super Lifesaver, Manikin Lifesaver Medley, Medley Relay, Rescue Tow Relay) (DQ8).
- H. Taking assistance from any pool fittings (e.g., lane ropes, steps, drains or underwater hockey fittings) is not permitted (DQ17, DQ24).
- I. A competitor who interferes with another competitor during a race shall be disqualified (DQ2).
- J. Unless otherwise specified in event rules, competitors must remain in their designated lane for the entire race and, at the conclusion of the race; competitors shall remain in the water in their lane until instructed to leave the pool (DQ9). Competitors must exit by the sides of the pool, not by the pool end over timing pads.
- K. All individual competitors and competitors from the same team shall wear their Official team swim caps in all events. Ocean event caps or rubber or silicone caps may be worn.

- L. A competitor shall not be disqualified if their cap is displaced or lost after the start of a race provided that Officials are able to identify that the competitor correctly completed the race.
- M. Order-of-finish decisions, whether by Judges or automated timing equipment, are not subject to protest or appeal.
- N. Start decisions by the Event Director, Starter, or Chief Referee (or Chief Referee's designate) are not subject to protest or appeal.
- O. The Chief Referee may permit a competitor or team to re-swim/run/throw a race due to provided equipment failure or interference. The re-swim/run/throw time shall become the Official time and inserted into the results.
- P. Retrieving lost fins: Competitors may retrieve fins lost after the start and continue without disqualification as long as the rules governing manikins are not violated (see S3-3 Manikins). Competitors are not permitted to start again in another heat.

## 2. THE START

- A. Prior to the start of each race, the Event Director or designated Officials shall:
  - Check that all Technical Officials are in position.
  - Check that competitors, manikin handlers and victims are properly attired and in correct positions.
  - Check that all equipment is in a safe and correct position.
  - Notify competitors by three short whistle blasts to position their equipment (if required and not already in place), remove all clothing and aids etc., except for swimwear and get ready to race.
- B. When competitors and Technical Officials are ready for a legal start, a designated Official shall:
  - Signal the Official start of each race with a long whistle indicating that the competitors should take their position on the starting platform or, for the Manikin Relay event, enter the water.
  - Signal the Starter (that the competitors are under the Starter's control) with an outstretched arm in the direction of the course.
- C. Notwithstanding that the above procedure is undertaken Officials are not responsible if a competitor or team are not in attendance for the start of a race or are improperly attired i.e., no protest or appeal is permitted by a competitor/team/handler on the above points.

**Note 1:** At the discretion of the Chief Referee, "over the top" starts may be used.

**Note 2:** See event description for start procedure for Line Throw (see S3-14).

### 2.1 Dive start procedure

The one-start rule shall be used.

- A. On the long whistle, competitors step onto the starting platform and remain there.
- B. On the Starter's "Take your Marks" command, competitors immediately assume a starting position with at least one foot at the front of the starting platform. When all competitors are stationary, the Starter gives the acoustic starting signal.
- C. Competitors may start on the starting platform, or on the pool deck, or in the water with one hand in contact with the starting wall/edge or starting block.

### 2.2 In-water start procedure

The one-start rule shall be used.

Refer to the individual event descriptions for the detailed start procedures for the Manikin Relay and Line Throw events that begin with an in-water start.

### 2.3 Disqualification

- A. All competitors who start (i.e., initiate a starting motion) before the starting signal has been given, shall be disqualified (DQ10).

Movement by itself is not a disqualification. Anticipating the starting signal and initiating a starting motion is a disqualification (DQ10).

The Event Director, Starter, and Chief Referee use their discretion in determining whether a competitor – or more than one competitor – has commenced a starting motion. Commonly, the early starting motion of one competitor causes movement by other competitors. Such movements are not a DQ.

**Note:** If installed the electronic (pressure) systems on starting blocks may be used to assist adjudicate on starting (and relay changeover) breaks.

- B. If the starting signal sounds before the disqualification is declared, the race shall continue, and the competitor(s) shall be disqualified upon completion of the race (DQ10).
- C. If the disqualification is declared before the starting signal, the signal shall not be given; the remaining competitors shall be called back and start again (DQ10).
- D. The signal to call back the competitors shall be the same as the starting signal but repeated along with dropping of the false start rope. Alternatively, if the Chief Referee or Chief Referee's designate decides that the start is not fair, the Chief Referee (or Chief Referee's designate) shall blow a whistle, to be followed by the Starter's signal (repeated).
- E. For the 100m Manikin Carry with Fins event, the call-back signal will be by an underwater acoustic signal whenever possible. Competitors will be advised if an alternate call-back signal is to be used.
- F. If an error by an Official follows a fault by a competitor, the fault of the competitor may be expunged.

**Note 1:** The duty of the Event Director, Chief Referee and Starter is to ensure a fair start. If the Event Director, Starter, or Chief Referee decides that a start is not fair, for any reason, including technical or equipment fault, the competitors shall be called back, and the race shall be started again.

**Note 2:** Start decisions by the Event Director, Starter, or Chief Referee (or Chief Referee's designate) are not subject to protest or appeal.

### 3. MANIKINS

#### 3.1 Competitors surfacing the manikin

- A. Competitors may push off the pool bottom when surfacing with the manikin.
- B. Competitors must:
  - Break the surface of the water while holding the manikin with at least hand and/or arm before the top of the manikin's head passes the designated 5m line (Manikin Carry, Rescue Medley, Super Lifesaver) or 10m line (Manikin Carry with Fins).

**Note:** "Break the surface" while holding the manikin means that the competitor's head must break the plane of the surface of the water.
  - Have the manikin in a correct carrying position when the top of the manikin's head passes the designated 5/10m line.
  - Remain at the surface beyond the designated 5/10m line.
  - Maintain contact with the manikin at all times beyond the designated 5/10m line until touching the finish wall/edge or the turning wall/edge (as appropriate).

**Note 1:** "Surface" means the horizontal plane of the surface of a still water pool.  
**Note 2:** The manikin judging criteria applies only when the top of the manikin's head passes the relevant 5/10m line.

#### 3.2 Carrying the manikin

- A. In events where the manikin is carried, the manikin (as victim) is presumed to be non-breathing. Water over the face is not a judged criterion.
- B. Competitors must carry the manikin with at least one hand and/or arm and must always be in contact with the manikin.
- C. When carrying the manikin, the **top of the** competitors head must be forward of the top of the manikin's head.
- D. Competitors must carry the manikin with the head of the manikin facing the direction of the carry i.e., the manikin cannot be carried with the bottom of the manikin facing the direction of the carry.
- E. It is permitted for the manikin to be gripped or grasped by the throat (neck), mouth, nose, or eyes, or carried with an arm over or around the throat (neck) of the manikin. It is also permitted for the face of the manikin to be held against the body of the competitor.
- F. The manikin must not be gripped by the sealing plugs.
- G. The competitor and manikin are considered to be one unit and, when in the carry position, either must remain above the surface of the water.

**Note 1:** "Surface" means the horizontal plane of the surface of a still water pool.

**Note 2:** If the competitor **and** manikin are both fully "below the surface", when carrying it is a disqualification. However, there is no disqualification if the manikin is underwater and a competitor dips

below the surface of the water as part of their normal stroke or kick cycle provided that the competitor breaks the surface throughout the race with some part of their body such as their head or arm.

**Note 3:** If the competitor and manikin are both below surface as the result of the competitor's final stroke/lunge to touch the turning or finish wall/edge or for a relay exchange, it shall not be a disqualification provided that the lunge to the wall/edge is within the 5m pick up line (as judged when the top of the manikin's head passes within the 5m line). However, when carrying a manikin, the competitor must maintain contact with the manikin with at least one hand and/or arm at all times beyond the designated 5m line until touching the finish wall/edge or the turning wall/edge (as appropriate).

- H. Carrying the manikin judging criteria applies only when the top of the manikin's head passes the 5m or 10m line.
- I. In the 5m start zone and in the changeover zones of the Manikin Relay, and the changeover zone of the Lifesaver Relay event, competitors are not judged on carrying the manikin criteria. However, competitors must maintain contact with at least one hand and/or arm with the manikin at all times including during the manikin exchanges.

**Note:** As with all events, the standard "carrying the manikin" criteria (defined in this section) apply to the final relay competitor at the finish of the Manikin Relay and Lifesaver Relay.

### 3.3 Towing the manikin

- A. In events where the manikin is towed, the manikin (as victim) is presumed to be breathing. Before the tow, competitors must secure the manikin correctly within the 10m change-over zone. "Correctly" means the rescue tube is secured around the body and under **or on the** arms of the manikin and clipped to an O-ring.

**Note 1:** For the purpose of this rule the rescue tube includes any part of the tube and line being secured under or on the arms of the manikin and clipped to an O-ring.

**Note 2:** It is not a disqualification where the minimum pool depth allows the competitor to stand/walk within the 10m change-over zone while securing the manikin (or victim in the Rescue Tow Relay) around the rescue tube provided the top of the manikin's head (or victim) has not passed the 10m line. Competitors may not stand/walk after the manikin's head has passed the 10m line.

- B. Competitors may return back into the 10m change over zone to re-secure the manikin provided the top of the manikin's head has not passed the 10m line.
- C. Competitors may swim on their back, side or front and may use any kick or stroke while towing the manikin.
- D. Beyond the 10m change-over zone, competitors must tow the manikin correctly secured with the manikin face above the surface of the water.
- E. Competitors shall be disqualified if the rescue tube and manikin become separated. Competitors shall not be disqualified if the rescue tube slips from under one arm of the Manikin during the tow, provided that the rescue tube was "secured correctly" at the 10m line and the face of the manikin remains above the water surface.
- F. Competitors shall not be disqualified if the manikin rotates in the rescue tube as long as the manikin's face remains above the surface of the water. In addition, the manikin does not need to be carried headfirst provided it was secured correctly at the 10m line and the manikin's face remains above the surface of the water.
- G. Provided that the manikin is secured as defined and the line/rope of the rescue tube has not been intentionally shortened by the competitor/team prior to the commencement of a race for the purpose of towing the manikin (e.g. looping **and** tying/knotting or clipping the line/rope) the line/rope does not need to be fully extended during tow.

**Note:** With the exception of looping the line of the rescue tube around the neck of the manikin to shorten the line, competitors shall not be disqualified if the line of the rescue tube becomes wrapped around the Manikin or is otherwise shortened by a competitor during the conduct of a race.

### 3.4 Manikin handlers

- A. A member of the competitor's team assists as manikin handler in the Manikin Tow with Fins, the Super Lifesaver, and the Manikin Lifesaver Medley events. A registered team coach, manager or other team personnel are permitted to function as a handler. With the Chief Referee's approval, non-team members may also function as handlers.
- B. A manikin handler is not required to wear a competition cap.

- C. For the handover, a manikin handler, using at least one hand, holds the manikin upright anywhere within the allotted lane with the face of the manikin facing toward the turning edge/wall at the time the competitor touches the turning wall/edge. At their discretion the manikin handler is then free to choose when to release their hold on the manikin i.e. the manikin handler may immediately release their hold on the manikin, and it is also permitted for the manikin handler to be holding the manikin at the time the competitor secures the rescue tube around the manikin.
- D. Make every effort to ensure that any part of their person, the manikin they are holding, and/or any water movement they cause, does not impede any other competitor in the race.
- E. Manikin handlers may not intentionally enter the water during the event.
- F. Comply with all race instructions of Officials.

#### **4. SEEDING**

- A. Seeding shall be used.
- B. For pool events, competitors' times are required to be submitted for both individual and team events. Competitors and teams shall be ranked according to the entry times.
- C. Competitors for whom no times are submitted shall be considered to have the slowest times.
- D. Placement of competitors with identical times and placement of those without times shall be determined by draw.

##### **4.1 Seeding in heats**

Where events are conducted as heats and finals (according to the entries received), competitors shall be seeded in heats according to submitted times in the following manner:

- A. If one heat:
- It shall be seeded as a final and swum during the final session.
- B. If two heats:
- The fastest competitor shall be seeded in the second heat, next fastest in the first heat, next fastest in the second heat, next in the first heat, etc.
- C. If three heats:
- The fastest swimmer shall be placed in the third heat, next fastest in the second, next fastest in the first. The fourth fastest shall be placed in the third heat, the fifth in the second heat, and the sixth fastest in the first heat, the seventh fastest in the third heat, etc.
- D. If four or more heats:
- The last three heats of the event shall be seeded in accordance with point C above. The heat preceding the last three heats shall consist of the next fastest competitors; the heat preceding the last four heats shall consist of the next fastest competitors, etc. Lanes shall be assigned in descending order of submitted times within each heat, in accordance with the pattern outlined in Assignment of lanes below.
- E. Exception:
- When there are two or more heats in an event, there shall be a minimum of three competitors seeded into any one preliminary heat.

##### **4.2 Seeding in time-finals**

Where events are conducted as time-finals, competitors shall be seeded into heats according to submitted times in the following manner:

- A. If one heat
- It shall be seeded as a final.
- B. If two or more heats
- The fastest competitors shall be seeded in the last heat according to assignment of lanes detailed in the next section, the next fastest competitors into the second last heat, and so on until all competitors have been allocated a heat and lane according to submitted times.

##### **4.3 Assignment of lanes**

Lanes shall be assigned by placing the fastest competitor or team in lane four of an eight-lane pool. (Lane one is on the right side of the pool viewed from the starting end.) The competitor having the next fastest time

is placed on the left of the fastest, then alternating other competitors to right and left in accordance with the submitted times. Competitors with identical times shall be assigned lane positions by draw within the aforesaid pattern.

#### 4.4 Seeding in finals

Starting positions for pool events shall be by seeding as follows:

- A. Based on the times established in heats, competitors with the top eight times shall be assigned lanes in the A-final. Competitors with the ninth through sixteenth top times shall be assigned lanes in the B-final.
- B. In the event that competitors from the same or different heats have equal times registered to 1/100 second for either the eighth place or sixteenth place, there shall be a swim-off to determine which swimmer shall advance to the appropriate finals. Such swim-off shall take place not less than one hour after all involved competitors have completed their heat (unless affected competitors agree to a shorter time interval). Another swim-off will take place if equal times are registered again.
- C. Competitors or teams who withdraw or did not start (DNS) in an A or B final shall not earn any points to their team's point score (i.e., zero points are scored for a "no show").
- D. Where one or more competitors or teams withdraw from an A-final, competitors shall be called forward from the B-final, alternate competitors up to a maximum of four competitors shall be called forward from the heats. Should insufficient reserves be on standby the B final shall progress with those who have marshalled. If there is sufficient time both finals will be re-seeded based on heat times.

**Note:** In pool events, reserves shall be determined based on heat times.

### 5. TIMEKEEPING AND DETERMINATION OF PLACING

Automatic officiating equipment should be used for all pool events to record the time of each competitor and to determine the place of each competitor.

#### 5.1 Automatic officiating equipment

- A. For ILS or ILS Sanctioned competition times recorded by automatic officiating equipment shall be used to determine the winner and all placings, and the time applicable to each lane. Results shall be recorded to 1/100 of a second.
- B. As a minimum the automatic officiating equipment must be activated by the Starter and must provide digital readings of competitors' times.
- C. In addition to the electronic timekeeping, a minimum of two timekeepers per lane are required. These timekeepers may operate both the back-up stops (buttons or plungers) and separate (manual) stopwatches.
- D. The times and placings determined by automatic officiating equipment shall have precedence over the decision of Judges and timekeepers including back-up stops (buttons or plungers) and (manual) stopwatches.
- E. If there are two (2) or three (3) stopwatches per lane and the automatic Official equipment fails, the order of finish will be determined by the times recorded by the timekeepers (using back-up stop button/plungers or (manual) stopwatches) i.e., the recorded times shall have precedence over the decision of finish judges.
- F. If there is one (1) stopwatch per lane and the automatic officiating equipment fails, the order of finish determined by the decision of finish judges will have precedence over the times recorded by the timekeepers (including the back-up stop button/plunger or using a (manual) stopwatch – see below).
- G. If the automated officiating equipment fails, for one or more competitors in a race the following will apply to determining placings and times to be allocated to competitors only in the lanes with automatic equipment has failed:
  - If the time determined by the back-up stop (button or plunger) operated by the timekeepers aligns with the order of finish decision of judges, this will be the Official placing and time.
  - If the time determined by the back-up stop (button or plunger) operated by the timekeepers does not align the following will apply to determining the time to be allocated (but only in the lanes where the automated officiating equipment has failed):
    - With three timekeepers per lane, where two of them have the same time, this time shall be considered Official. If the three timekeepers differ, the middle time shall be Official. If one

watch fails, the average of the other two times shall constitute the competitor's Official time (and place).

- With two timekeepers per lane, where they have the same time, this time shall be considered Official. If the two timekeepers differ, the average of the two times shall be Official. If one watch fails, the remaining time shall constitute the competitor's Official time.
- Note: The placing of the competitor(s) shall be determined by the timekeepers.
- If the order of finish decision of judges does not align with the times recorded by manual timekeepers, the times assigned to the competitors involved shall be made to be identical. For example, if two competitors are involved, and there is no correctly recorded time by the automatic equipment, the times assigned to both competitors shall be calculated as the sum of their individual times recorded divided by the number of separate stopwatches of the involved competitors with the leading competitor, as determined by the finish judges, declared the winner.

H. Any equipment installed must not interfere with competitors' start and turns.

## **5.2. Manual time keeping, finish judging, and officiating**

- A. In ILS-sanctioned lifesaving competitions where automatic officiating equipment is unavailable or fails, the time must be recorded for the competitor/team by three timekeepers for any ILS records to be recognised. There shall also be two additional timekeepers designated, either of whom shall be directed to replace a timekeeper whose watch did not start or stopped during an event, or who for any other reason is not able to record the time.
- B. Watches are started when the starting signal is given and stopped when the competitor/team touches (clearly visible to the timekeeper) the finish wall/edge with any part of the competitor's body.
- C. If there are two (2) or three (3) stopwatches per lane, and all record times, the order of finish determined by the times recorded by shall have precedence over the decision of finish judges.
- D. If there is one (1) stopwatch per lane the order of finish is determined by decision of finish judges.
- Note: At major competitions (e.g., ILS World Championships and ILS Sanctioned events), the appointment of a video judge is recommended to record finishes from an elevated position. A minimum 9 inch/228mm (measured on the diagonal) tablet type device or better with high definition should be used. Such video is to be referred to by finish judges to confirm results.
- E. With three timekeepers, where two of them have the same time, this time shall be considered Official. If the three timekeepers differ, the middle time shall be Official. If one watch fails, the average of the other two times shall constitute the competitor's Official time.
- F. With two timekeepers, where they have the same time, this time shall be considered Official. If the two timekeepers differ, the average of the two times shall be Official. If one watch fails, the remaining time shall constitute the competitor's Official time.
- G. If the order of finish decision of judges does not align with the times recorded by the manual timekeepers, the times assigned to the competitors involved shall be made to be identical. For example, if two competitors are involved, the times assigned to both competitors shall be calculated as the sum of their individual times recorded divided by the number of separate stopwatches of the involved competitors with the leading competitor, as determined by the finish judges, declared the winner.

## **6. TECHNICAL OFFICIALS**

- A. Technical Officials ensure that events operate fairly and within ILS rules and procedures.
- B. Technical Officials also assess whether competitors' technique complies with specific event rules.
- C. Technical Officials must be positioned to ensure they have a clear view of the lane they are judging.

## 7. OBSTACLE SWIM (200M AND 100M)

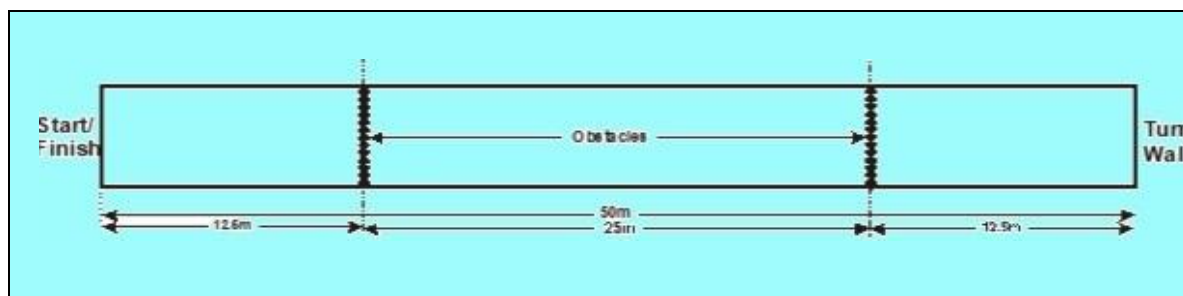

**FIGURE 1: OBSTACLE SWIM (200M AND 100M)**

### 7.1. Event description – 200m

With a dive start on an acoustic signal, the competitor swims the 200m course passing eight times under the immersed obstacles to touch the finish wall/edge of the pool.

- A. Competitors must break the surface of the water after the dive entry before the first obstacle; after passing under each obstacle; and after a turn prior to passing under an obstacle.

Note: “Break the surface” means that the competitor’s head must break the plane of the surface of the water.

- B. Competitors may push off the pool bottom when surfacing from under each of the obstacles.
- C. Swimming into or otherwise bumping an obstacle is not a behaviour that results in disqualification.

### 7.2. Event description – 100m

With a dive start on an acoustic signal, the competitor swims the 100m course passing four times under the immersed obstacles to touch the finish wall/edge of the pool.

- A. Competitors must surface after the dive entry before the first obstacle; after passing under each obstacle; and after a turn prior to passing under an obstacle.
- B. Competitors may push off the pool bottom when surfacing from under each of the obstacles. Surfacing” means the competitor’s head breaks the plane of the surface of the water.
- C. Swimming into or otherwise bumping an obstacle is not a behaviour that results in disqualification.

### 7.3. Equipment

Obstacles: See Section 8.

Obstacles are fixed at right angles onto lane ropes in a straight line across all lanes. The first obstacle is located 12.5m from the start wall, with the second obstacle located 12.5m from the opposite end. The distance between the two obstacles is 25m.

### 7.4. Disqualification

In addition to Section 2 and those rules outlined in S3-1 to S3-3, the following behaviour shall result in disqualification:

- A. Passing over an obstacle without immediately returning over or under that obstacle and then passing under it (DQ11).
- B. Failure to surface after the dive entry or after a turn before and after passing under an obstacle. (DQ12).
- C. Taking assistance from any pool fitting (e.g., lane rope, steps, drains or underwater hockey fittings) when surfacing – not including the bottom of the pool (DQ17).
- D. Failure to touch the wall/edge during the turn (DQ13).
- E. Failure to touch the finish wall/edge (DQ14).

## 8. MANIKIN CARRY (50M)

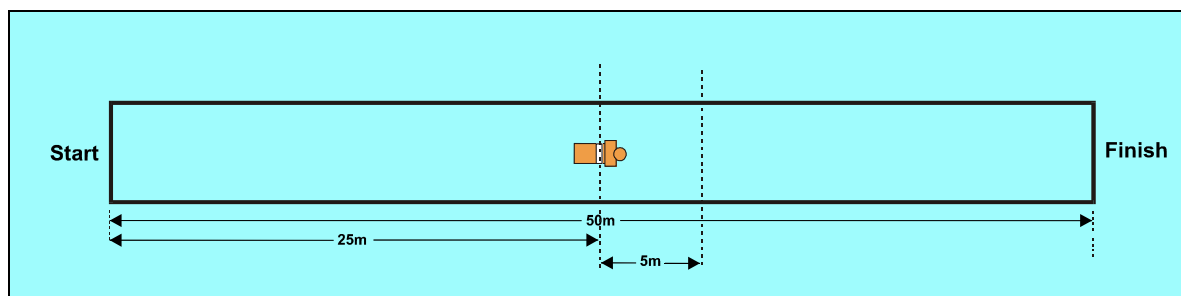

FIGURE 2: MANIKIN CARRY (50M)

### 8.1. Event description

With a dive start on an acoustic signal, the competitor swims 25m freestyle and then dives to recover a submerged manikin.

- A. Competitors must break the surface of the water after the dive entry and before diving to recover the manikin.

Note: “Break the surface of the water” when means that the competitor’s head must break the plane of the surface of the water.

- B. The competitor surfaces the manikin within the 5m pick-up zone and carries it with at least one hand and/or arm to the finish wall/edge of the pool.

**Note:** “Surfacing with the Manikin means that the competitor’s head must break the plane of the surface of the water while holding the manikin with at least one hand or arm before the top of the manikin’s head passes the designated 5m line.

- C. Competitors may push off the pool bottom when surfacing with the manikin.  
D. The event is complete when the competitor touches the finish wall/edge of the pool.

### 8.2. Equipment

- A. Manikin: See Section 8.
- The manikin is completely filled with water and sealed for the event. Competitors must use the manikins supplied by Organisers.
- B. Positioning the manikin: The manikin is located at a depth between 1.8 m and 3 m. In water deeper than 3m, the manikin shall be placed on a platform (or other suitable support) to position it at the required depth.
- C. The manikin is positioned on its back, the head in the direction of the finish, with the top of the transverse line on the 25m line.
- D. Surfacing the manikin: Competitors must have the manikin in the correct carrying position before the top of the manikin’s head passes the 5m line.

### 8.3. Disqualification

In addition to Section 2 and those rules outlined in S3-1 to S3-3, the following behaviour shall result in disqualification:

- A. Not surfacing before diving to the manikin (DQ15).  
B. Taking assistance from any pool fitting (e.g., lane rope, steps, drains or underwater hockey fittings) when surfacing with the manikin – not including the bottom of the pool (DQ17).  
C. Not having the manikin in the correct carrying position before the top of the manikin’s head passes the 5m line (DQ18).  
D. Using an incorrect carrying technique as described in S3-3 Manikins (DQ19).  
E. Releasing the manikin before touching the finish wall/edge (DQ21).  
F. Failure to touch the finish wall/edge (DQ14).

## 9. RESCUE MEDLEY (100M)

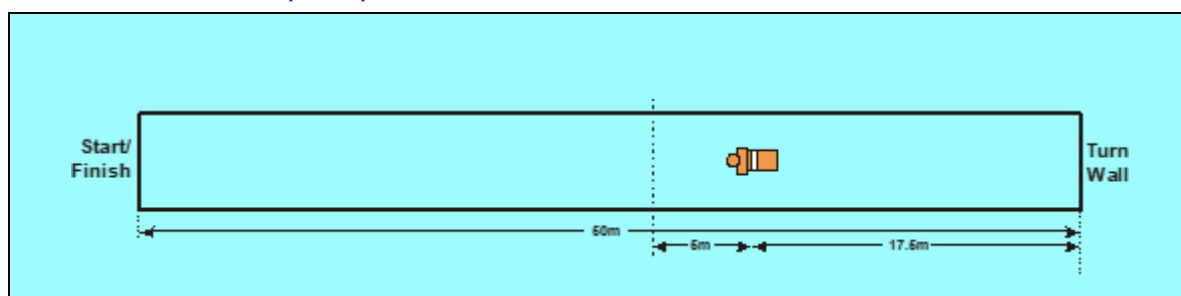

FIGURE 3: RESCUE MEDLEY (100M)

### 9.1. Event description

With a dive start on an acoustic signal, the competitor swims 50m freestyle to turn, dive, and swim underwater to a submerged manikin located at 17.5m from the turning wall.

- A. Competitors must break the surface of the water after the dive entry and before touching the 50m turning wall/edge and before turning and diving to recover the manikin.

**Note:** “Break the surface” when swimming means that the competitor’s head must break the plane of the surface of the water.

- B. The competitor surfaces the manikin within the 5m pick-up line and then carries it with at least one hand and/or arm the remaining distance to touch the finish wall/edge.

**Note:** “Surfacing with the Manikin means that the competitor’s head must break the plane of the surface of the water while holding the manikin with at least one hand or arm before the top of the manikin’s head passes the designated 5m line.

- C. Competitors are permitted to take a breath, or breaths before, at, or during the turn, but must not take a breath after their feet and/or hands leave the turning wall/edge to swim underwater to the manikin and until they surface with the manikin.
- D. Competitors may push off the bottom when surfacing with the manikin but not during the underwater swim to the manikin.

### 9.2. Equipment

- A. Manikin: See Section 8. The manikin is completely filled with water and sealed for the event. Competitors must use the manikins supplied by Organisers.

- B. Positioning the manikin:

- The manikin is positioned at a depth between 1.8m and 3m. In water deeper than 3m, the manikin shall be placed on a platform (or other suitable support) to position it at the required depth.
- The manikin is positioned on its back, head in the direction of the finish, with the top of the transverse line on the 17.5m line.

- C. Surfacing the manikin: Competitors must have the manikin in the correct carrying position before the top of the manikin’s head passes the 5m line.

### 9.3. Disqualification

In addition to Section 2 and those rules outlined in S3-1 to S3-3, the following behaviour shall result in disqualification:

- A. Competitor not surfacing after the dive entry and before touching the 50m turning wall/edge. (DQ16).
- B. Surfacing after turning and before lifting the manikin (DQ22).
- C. Taking assistance from any pool fitting (e.g., lane rope, steps, drains or underwater hockey fittings) when surfacing with the manikin – not including the bottom of the pool (DQ17).
- D. Not having the manikin in the correct carrying position before the top of the manikin’s head passes the 5m line (DQ18).
- E. Using an incorrect carrying technique as described in S3-3 Manikins (DQ19).
- F. Releasing the manikin before touching the finish wall/edge (DQ21).
- G. Failure to touch the finish wall/edge (DQ14).

## 10. MANIKIN CARRY WITH FINS (100M)

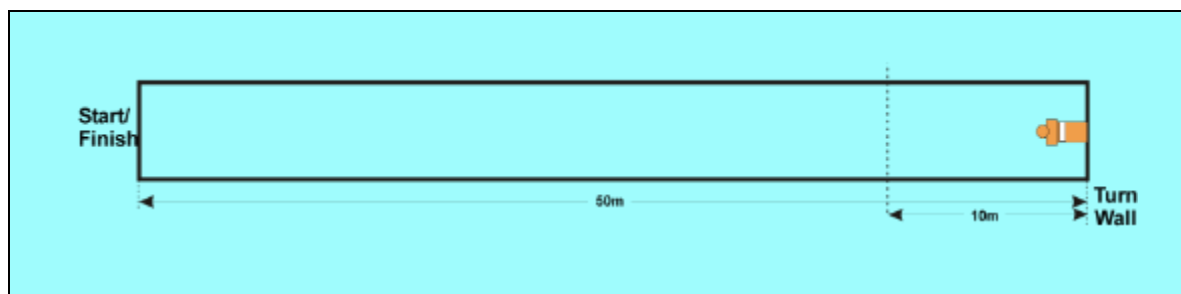

**FIGURE 4: MANIKIN CARRY WITH FINS (100M)**

### 10.1. Event description

With a dive start on an acoustic signal, the competitor swims 50m freestyle wearing fins and then recovers a submerged manikin. The competitor surfaces the manikin within the 10m pick-up line and then carries it with at least one hand and/or arm the remaining distance to touch the finish wall/edge.

- A. Surfacing with the Manikin means that the competitor's head must break the plane of the surface of the water while holding the manikin with at least one hand or arm before the top of the manikin's head passes the designated 10m line.
- B. Competitors need not surface before touching the manikin.
- C. Competitors do need not touch the turning wall/edge of the pool.
- D. Competitors may push off the bottom when surfacing with the manikin.

### 10.2. Equipment

- A. Manikins, fins: See Section 8. The manikin is completely filled with water and sealed for the event. Competitors must use the manikins supplied by Organisers.
- B. Positioning the manikin: The manikin is located at a depth between 1.8m and 3m. In water deeper than 3m, the manikin shall be placed on a platform (or other suitable support) to position it at the required depth.

The manikin is positioned on its back in contact with the pool bottom and its base touching the pool wall, with its head in the direction of the finish.

Where the facility design does not provide a vertical wall that joins the bottom at 90 degrees, the manikin must be positioned as close as possible to the wall, but no further than 300mm from the wall as measured at the water surface.

- C. Surfacing the manikin: Competitors must have the manikin in the correct carrying position before the top of the manikin's head passes the 10m line.
- D. Retrieving lost fins: Competitors may retrieve fins lost after the start and continue without disqualification as long as the rules governing manikins are not violated (see 3.3 Manikins). Competitors are not permitted to start again in another heat.

### 10.3. Disqualification

In addition to Section 2 and those rules outlined in S3-1 to S3-3, the following behaviour shall result in disqualification:

- A. Taking assistance from any pool fitting (e.g., lane rope, steps, drains or underwater hockey fittings) when surfacing with the manikin – not including the bottom of the pool (DQ17).
- B. Not having the manikin in the correct carrying position before the top of the manikin's head passes the 10m line (DQ23).
- C. Using an incorrect carrying technique as described in S3-3 Manikins (DQ19).
- D. Releasing the manikin before touching the finish wall/edge (DQ21).
- E. Failure to touch the finish wall/edge (DQ14).

## 11. MANIKIN TOW WITH FINS (100M)

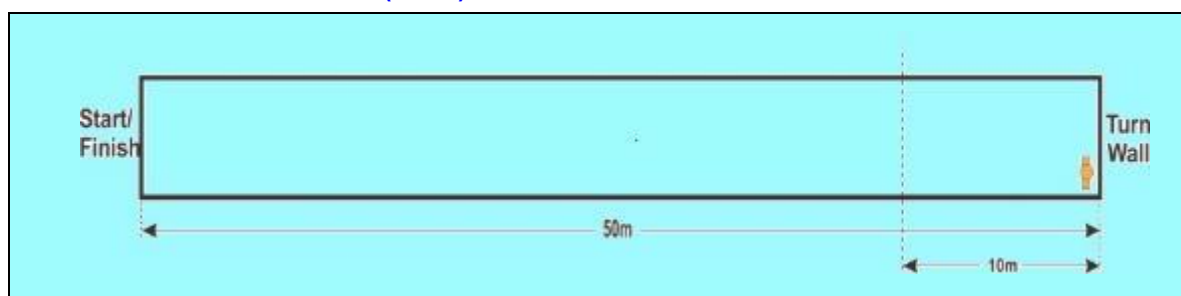

FIGURE 5: MANIKIN TOW WITH FINS (100M)

### 11.1. Event description

With a dive start on an acoustic signal, the competitor swims 50m freestyle with fins and rescue tube. After touching the turning wall/edge, and within the 10m change-over zone, the competitor fixes the rescue tube correctly around a manikin and tows it to the finish. The event is complete when the competitor touches the finish wall/edge of the pool.

- A. Competitors need not surface before touching the turning wall/edge.

### 11.2. Equipment

- A. Manikin, fins, rescue tube: See Section 8. Competitors must use the manikins and rescue tubes supplied by Organisers. The manikin is filled with water and sealed so that it floats with the top of its transverse line at the surface.
- B. Positioning the manikin: For the handover, a manikin handler, using at least one hand, holds the manikin upright anywhere within the allotted lane with the face of the manikin facing toward the turning edge/wall at the time the competitor touches the turning wall/edge. Manikin handlers may not intentionally enter the water during the event.
- C. Starts with rescue tubes: At the start, the rescue tube and rescue tube line may be positioned at the competitor's discretion, but within the competitor's allotted lane. Competitors should ensure a safe and correct position of rescue tube and line. The rescue tube remains unclipped in the rescue tube and rescue tube line until secured around the manikin.

**Note:** Although the rescue tube and rescue tube line may be positioned at the competitor's discretion for the start (including the line/rope being wrapped around their body, tucked into swimsuits, etc.), competitors shall be disqualified if the rescue tube tow line/rope is tied/knotted or clipped within itself to intentionally shorten the line/rope prior to the commencement of a race.

- D. Wearing rescue tubes: Rescue tubes must be donned correctly, either with the lanyard/harness over one or both shoulders, or over one shoulder and across the chest – at the competitor's discretion. Assuming the rescue tube was donned correctly, there is no cause for disqualification if the lanyard/harness falls down on the competitor's arm or elbow or is re positioned during the competitor's approach to the manikin or during the manikin tow.

- E. Securing the manikin: After first touching the turning wall/edge, the competitor then secures the manikin correctly with the rescue tube around the body and under **or on the** arms of the manikin, and clipped to an O-ring, within the 10m change-over zone. Competitors may go back into the 10m change over zone to re-secure the manikin. provided the top of the manikin's head has not passed the 10m line.

**Note 1:** Unintentionally touching the manikin before touching the turning wall/edge is not a disqualification.

**Note 2:** Standing or walking while clipping the rescue tube around the manikin is not a disqualification provided that the top of the manikin's head remains within the 10m changeover zone.

- F. Towing the manikin: Competitors must tow the manikin as detailed in the general conditions for pool competition. The rescue tube must be attached to the manikin by the time the top of the manikin's head passes the 10m line.

**Note 1:** Refer to starts with rescue tubes - Competitors shall be disqualified if the tow line/rope of the rescue tube is intentionally shortened by a competitor prior to the commencement of a race for the purpose of towing the manikin (e.g. looping **and** tying/knotting or clipping the line/rope).

**Note 2:** Competitors shall not be disqualified if the line of the rescue tube becomes wrapped around the Manikin or is otherwise shortened by a competitor during the conduct of a race.

- G.** Competitors shall be disqualified if the rescue tube and manikin become separated. Competitors shall not be disqualified if the rescue tube slips from under one arm of the Manikin during the tow, provided that the rescue tube was “secured correctly” at the 10m line and the face of the manikin remains above the water surface.
- H.** Competitors shall not be disqualified if the manikin rotates in the rescue tube as long as the manikin’s face remains above the surface of the water. The manikin does not need to be carried headfirst provided it was secured correctly at the 10m line and the manikin’s face remains above the surface of the water.
- I.** Retrieving lost fins: Competitors may retrieve fins lost after the start and continue without disqualification as long as the rules governing manikins are not violated (see S3-3 Manikins). Competitors are not permitted to start again in another heat.
- J.** Rescue Tube Defect: If in the opinion of the Chief Referee the rescue tube, line and/or harness (belt) presents a technical defect during the race, the Chief Referee may allow the competitor to start again in another heat but only if the rescue tubes for the event were supplied by the organising body and the rules required that the provided tubes must be used by all competitors.

### 11.3. Disqualification

In addition to Section 2 and those rules outlined in S3-1 to S3-3, the following behaviour shall result in disqualification:

- A. Taking assistance from any pool fitting (e.g., lane rope, steps, underwater hockey fittings) when fixing the rescue tube around the manikin except where the minimum pool depth allows the competitor to stand/walk while securing the rescue tube around the manikin provided the top of the manikin’s head has not passed the 10m line. (DQ24).
- B. Competitor clipping the rescue tube into the ring before touching the turning wall/edge. (DQ28)
- C. Manikin handler releasing the manikin before the competitor touches the turning wall/edge (DQ26).
- D. Manikin handler intentionally entering the water during the event or entering the water and interfering with the performance of another competitor or interfering with the judging of the event (DQ27).
- E. At 50m, the competitor not touching the pool wall/edge before intentionally touching the manikin (DQ25).
- F. Incorrectly securing the rescue tube around the manikin (i.e., not around body and under **or on the** arms and not clipped to an O-ring) (DQ29).
- G. Not securing the rescue tube around the manikin within the 10m change-over zone, judged at the top of the manikin’s head (DQ30).
- H. The line/rope of the rescue tube being intentionally shortened by a competitor prior to the commencement of a race for the purpose of towing the manikin (DQ32).
- I. Towing the manikin with the face below the surface (DQ20).
- J. Pushing or carrying, instead of towing, the manikin (DQ31).
- K. The rescue tube and manikin become separated after the rescue tube has been secured correctly around the manikin (DQ33).
- L. Touching the finish wall/edge without the rescue tube and manikin in place (DQ34).
- M. Failure to touch the finish wall/edge (DQ14).

## 12. SUPER LIFESAVER (200M)

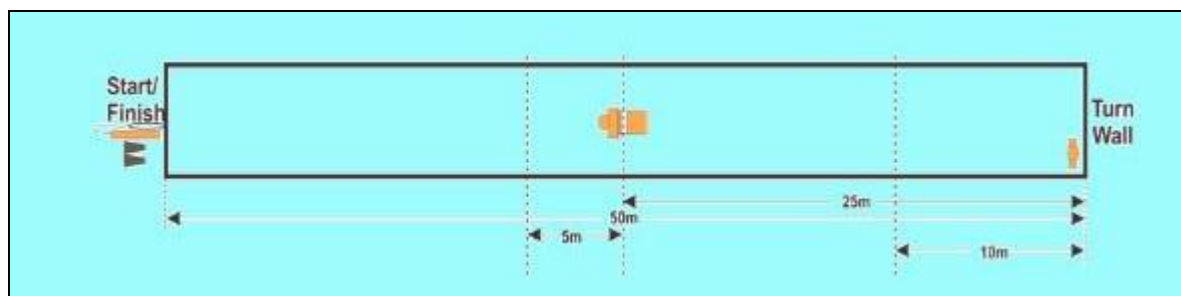

FIGURE 6: SUPER LIFESAVER (200M)

### 12.1. Event description

With a dive start on an acoustic signal, the competitor swims 75m freestyle and then dives to recover a submerged manikin.

- A. Competitors must break the surface of the water after the dive entry and before touching the 50m turning wall/edge

**Note:** “Breaking the surface” when swimming means that the competitor’s head must break the plane of the surface of the water.

- B. The competitor surfaces the manikin within the 5m pick-up line and then carries it with at least one hand and/or arm the remaining distance to touch the turning wall/edge. After touching the wall/edge, the competitor releases the manikin.

**Note:** Surfacing with the Manikin means that the competitor’s head must break the plane of the surface of the water while holding the manikin with at least one hand or arm before the top of the manikin’s head passes the designated 10m line.

- C. In the water, the competitor puts on fins and rescue tube and swims 50m freestyle. After touching the wall/edge, and within the 10m change-over zone, the competitor fixes the rescue tube correctly around a manikin and tows it to the finish.
- D. The event is complete when the competitor touches the finish wall/edge of the pool.

### 12.2. Equipment

- A. Manikins, fins, rescue tubes: See Section 8. Competitors must use the manikins and rescue tubes supplied by Organisers. The first manikin that is used for the carry is completely filled with water and sealed for the event. The second manikin that is used for the tow is filled with water and sealed so that it floats with the top of its transverse line at the surface.

- B. Placement of fins and rescue tubes: Prior to the start, competitors must place the fins and rescue tube on the pool deck – not the starting block/podium – within the confines of their allotted lane. The rescue tube remains unclipped until secured around the manikin.

**Note:** Although the rescue tube and rescue tube line may be positioned at the competitor’s discretion, competitors shall be disqualified if the rescue tube tow line/rope is tied/knotted or clipped within itself to intentionally shorten the line/rope prior to the commencement of a race.

- C. Positioning the manikin for the carry: The manikin is located at a depth between 1.8m and 3m. In water deeper than 3m, the manikin shall be placed on a platform (or other support) to position it at the required depth.

The manikin is positioned on its back, head in the direction of the finish with the top of the transverse line on the 25m line.

- D. Surfacing the first manikin: Competitors may push off the bottom of the pool when surfacing with the manikin.

Competitors must have the manikin in the correct carrying position before the top of the manikin’s head passes the 5m line.

- C. Donning tube and fins: After first touching the turning wall/edge, the competitor discards the first manikin. In the water, the competitor don’s fins and rescue tube and swims 50m freestyle.

**Note:** It is permitted to maintain contact with the turning wall/edge while donning the rescue tube and/or fins.

- F. Wearing rescue tubes: Rescue tubes must be donned correctly, either with the lanyard/harness over one or both shoulders, or over one shoulder and across the chest – at the competitor’s discretion.

**Note:** Assuming the rescue tube was donned correctly, there is no cause for disqualification if the lanyard/harness falls down on the competitor’s arm or elbow or is re positioned during the competitor’s approach to the manikin or during the manikin tow.

- G. Positioning the manikin: For the handover, a manikin handler, using at least one hand, holds the manikin upright anywhere within the allotted lane with the face of the manikin facing toward the turning edge/wall at the time the competitor touches the turning wall/edge. Manikin handlers may not intentionally enter the water during the event.

- H. Securing the manikin: After first touching the turning wall/edge, the competitor then secures the manikin correctly with the rescue tube around the body and under **or on the** arms of the manikin, and clipped to an O-ring, within the 10m change-over zone. Competitors may go back into the 10m change over zone to re-secure the manikin provided the top of the manikin’s head has not passed the 10m line.

**Note 1:** Unintentionally touching the manikin before touching the turning wall/edge is not a disqualification.

**Note 2:** Standing or walking while clipping the rescue tube around the manikin is not a disqualification provided that the top of the manikin’s head remains within the 10m changeover zone.

- I. Towing the manikin: Competitors must tow the manikin as detailed in the general conditions for pool competition. The rescue tube must be attached to the manikin by the time the top of the manikin’s head passes the 10m line.

**Note 1:** Refer to placement of fins and rescue tubes - Competitors shall be disqualified if the tow line/rope of the rescue tube is intentionally shortened by a competitor prior to the commencement of a race for the purpose of towing the manikin (e.g. looping **and** tying/knotting or clipping the line/rope).

**Note 2:** Competitors shall not be disqualified if the line of the rescue tube becomes wrapped around the Manikin or is otherwise shortened by a competitor during the conduct of a race.

- J. Competitors shall be disqualified if the rescue tube and manikin become separated. Competitors shall not be disqualified if the rescue tube slips during the tow, provided that the rescue tube was “secured correctly” at the 10m line and that the face of the manikin remains above the water surface.

- K. Competitors shall not be disqualified if the manikin rotates in the rescue tube as long as the manikin’s face remains above the surface of the water. The manikin does not need to be carried headfirst provided it was secured correctly at the 10m line and the manikin’s face remains above the surface of the water.

- L. Retrieving lost fins: Competitors may retrieve fins lost after the start and continue without disqualification as long as the rules governing manikins are not violated (see S3-3 Manikins). Competitors are not permitted to start again in another heat.

- M. Rescue Tube Defect: If in the opinion of the Chief Referee the rescue tube, line and/or harness (belt) presents a technical defect during the race, the Chief Referee may allow the competitor to start again in another heat but only if the rescue tubes for the event were supplied by the organising body and the rules required that the provided tubes must be used by all competitors.

### 12.3. Disqualification

In addition to Section 2 and those rules outlined in S3-1 to S3-3, the following behaviour shall result in disqualification:

- A. Competitor not surfacing after the dive entry and before touching the 50m turning wall/edge. (DQ16).
- B. Taking assistance from any pool fitting (e.g., lane rope, steps, drains or underwater hockey fittings) – not including the bottom of the pool when surfacing the manikin (DQ17).
- C. Not having the manikin in the correct carrying position before the top of the manikin’s head passes the 5m pick-up zone (DQ18).
- D. Using an incorrect carrying technique as described in S3-3 Manikins. (DQ19).
- E. Releasing the manikin before touching the turning wall/edge. (DQ21).
- F. Taking assistance from any pool fitting (e.g., lane rope, steps, underwater hockey fittings) when fixing the rescue tube around the manikin except where the minimum pool depth allows the competitor to

- 
- stand/walk while securing the rescue tube around the manikin provided the top of the manikin's head has not passed the 10m line. (DQ24).
- G. Competitor clipping the rescue tube into the ring before touching the turning wall/edge. (DQ28).
  - H. Manikin handler releasing the manikin before the competitor touches the turning wall/edge (DQ26).
  - I. Manikin handler intentionally entering the water during the event or entering the water and interfering with the performance of another competitor or interfering with the judging of the event (DQ27).
  - J. At 150m, the competitor not touching the pool wall/edge before intentionally touching the second manikin (DQ25).
  - K. Incorrect securing of the rescue tube around the manikin (i.e., not around body and under **or on the** arms and not clipped to an O-ring) (DQ29).
  - K. Not securing the rescue tube around the manikin within the 10m change-over zone judged at the top of the manikin's head (DQ30).
  - L. The line/rope of the rescue tube being intentionally shortened by a competitor prior to the commencement of a race, or by a handler, for the purpose of towing the manikin (DQ32).
  - M. Towing the manikin with the face below the surface (DQ20).
  - N. Pushing or carrying, instead of towing, the manikin (DQ31).
  - O. The rescue tube and manikin become separated after the rescue tube has been secured correctly around the manikin (DQ33).
  - P. Touching the finish wall/edge without the rescue tube and manikin in place (DQ34).
  - Q. Failure to touch the finish wall/edge (DQ14).

### 13. MANIKIN LIFESAVER MEDLEY (100M)

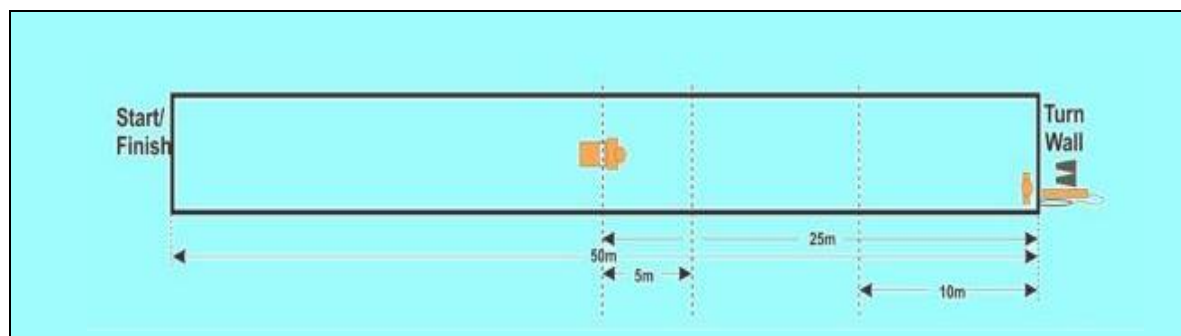

FIGURE 7: MANIKIN LIFESAVER MEDLEY (100M)

#### 13.1. Event description

With a dive start on an acoustic signal, the competitor swims 25m freestyle and then dives to recover a submerged manikin.

- Competitors must break the surface of the water after the dive entry and before diving to recover the manikin.
- “Breaking the surface” when swimming means that the competitor’s head must break the plane of the surface of the water.
- The competitors dive to recover the first manikin and surface the manikin within the 5m pick-up zone and carry it with at least one hand and/or arm to the turning wall/edge of the pool.

**Note:** Surfacing with the Manikin means that the competitor’s head must break the plane of the surface of the water while holding the manikin with at least one hand or arm before the top of the manikin’s head passes the designated 5m line.

- Competitors may push off the pool bottom when surfacing with the manikin. After touching the wall/edge, the competitor releases this manikin.
- In the water, the competitor puts on fins and rescue tube and within the 10m change-over zone, the competitor fixes the rescue tube correctly around a second manikin and tows it to the finish.
- The event is complete when the competitor touches the finish wall/edge of the pool.

#### 13.2. Equipment

- Manikins, fins, rescue tubes: See Section 8. Competitors must use the manikins and rescue tubes supplied by Organisers. The first manikin that is used for the carry is completely filled with water and sealed for the event. The second manikin that is used for the tow is filled with water and sealed so that it floats with the top of its transverse line at the surface.
- Placement of fins and rescue tubes: Prior to the start, the manikin handler must place the fins and rescue tube on the pool deck at the 50m turning edge – not the starting block/podium – within the confines of their competitor’s allotted lane. The rescue tube remains unclipped until secured around the manikin.

**Note:** Although the rescue tube and rescue tube line may be positioned at the competitor’s discretion, competitors shall be disqualified if the rescue tube tow line/rope is tied/knotted or clipped within itself to intentionally shorten the line/rope prior to the commencement of a race.

- Positioning the manikin for the carry: The manikin is completely filled with water and sealed for the event. The manikin is located at a depth between 1.8m and 3m. In water deeper than 3m, the manikin shall be placed on a platform (or other support) to position it at the required depth. The manikin is positioned on its back, head in the direction of the turning wall with the top of the transverse line on the 25m line.
- Surfacing the first manikin: The competitor may push off the bottom of the pool when surfacing with the manikin.
- Carry: The competitor must have the manikin in the correct carrying position before the top of the manikin’s head passes the 5m line. The competitor then carries the manikin as detailed in the general conditions for pool competition to the turn edge/wall.

- F. Positioning the manikin: For the handover, a manikin handler, using at least one hand, holds the manikin upright anywhere within the allotted lane with the face of the manikin facing toward the turning edge/wall at the time the competitor touches the turning wall/edge. Manikin handlers may not intentionally enter the water during the event.
- G. Second Manikin: After first touching the turning wall/edge and discarding the first manikin, the competitor dons their fins and rescue tube and then grasps the second manikin.  
**Note:** Unintentionally touching the second manikin before touching the turning wall/edge is not a disqualification.
- H. Securing the second manikin: The competitor must secure the manikin correctly with the rescue tube around the body and under **or on the** arms of the manikin, and clipped to an O-ring, within the 10m change-over zone. Competitors may go back into the 10m change over zone to re-secure the manikin provided the top of the manikin's head has not passed the 10m line.  
**Note:** Standing or walking while clipping the rescue tube around the manikin is not a disqualification provided that the top of the manikin's head has not passed the 10m line.
- I. Wearing rescue tubes: Rescue tubes must be donned correctly, either with the lanyard/harness over one or both shoulders, or over one shoulder and across the chest – at the competitor's discretion. Assuming the rescue tube was donned correctly, there is no cause for disqualification if the lanyard/harness falls down on the competitor's arm or elbow or is re positioned during the competitor's manikin tow.
- J. Towing the manikin: Competitors must tow the manikin as detailed in the general conditions for pool competition. The rescue tube must be attached to the manikin by the time the top of the manikin's head passes the 10m line.  
**Note 1:** Refer to placement of fins and rescue tubes - Competitors shall be disqualified if the tow line/rope of the rescue tube is intentionally shortened by a competitor prior to the commencement of a race for the purpose of towing the manikin (e.g. looping **and** tying/knotting or clipping the line/rope).  
**Note 2:** Competitors shall not be disqualified if the line of the rescue tube becomes wrapped around the Manikin or is otherwise shortened by a competitor during the conduct of a race.
- K. Competitors shall not be disqualified if the rescue tube slips during the tow, provided that the rescue tube was "secured correctly" at the 10m line and that the face of the manikin remains above the water surface.
- L. Competitors shall not be disqualified if the manikin rotates in the rescue tube as long as the manikin's face remains above the surface of the water. The manikin does not need to be carried headfirst provided it was secured correctly at the 10m line and the manikin's face remains above the surface of the water.
- M. Retrieving lost fins: Competitors may retrieve fins lost after the start and continue without disqualification as long as the rules governing manikins are not violated (see S3-3 Manikins). Competitors are not permitted to start again in another heat.
- N. Rescue Tube Defect: If in the opinion of the Chief Referee the rescue tube, line and/or harness (belt) presents a technical defect during the race, the Chief Referee may allow the competitor to start again in another heat but only if the rescue tubes for the event were supplied by the organising body and the rules required that the provided tubes must be used by all competitors.

### 13.3. Disqualification

In addition to Section 2 and those rules outlined in S3-1 to S3-3, the following behaviour shall result in disqualification:

- A. Not surfacing before diving to the first manikin (DQ15).
- B. Taking assistance from any pool fitting (e.g., lane rope, steps, drains or underwater hockey fittings) – not including the bottom of the pool when surfacing the manikin (DQ17).
- C. Not having the manikin in the correct carrying position before the top of the manikin's head passes the 5m pick-up zone (DQ18).
- D. Using an incorrect carrying technique as described in S3-3 Manikins (DQ19).
- E. Releasing the first manikin before touching the turning wall/edge (DQ21).
- F. Taking assistance from any pool fitting (e.g., lane rope, steps, underwater hockey fittings) when fixing the rescue tube around the manikin (as victim) except where the minimum pool depth allows the

- 
- competitor to stand/walk while securing the rescue tube around the manikin provided the top of the manikin's head has not passed the 10m line. (DQ24).
- G. Competitor clipping the rescue tube into the O-ring before touching the turning wall/edge. (DQ28).
  - H. Manikin handler releasing the manikin before the competitor touches the turning wall/edge (DQ26).
  - I. Manikin handler intentionally entering the water during the event or entering the water and interfering with the performance of another competitor or interfering with the judging of the event (DQ27).
  - J. At 50m, the competitor not touching the pool wall/edge before intentionally touching the second manikin (DQ25).
  - K. Incorrect securing of the rescue tube around the manikin (i.e., not around body and under **or on the** arms and not clipped to an O-ring) (DQ29).
  - L. Not securing the rescue tube around the manikin within the 10m change-over zone judged at the top of the manikin's head (DQ30).
  - M. The line/rope of the rescue tube being intentionally shortened by a competitor prior to the commencement of a race for the purpose of towing the manikin (DQ32).
  - N. Towing the manikin with the face below the surface (DQ20).
  - O. Pushing or carrying, instead of towing, the manikin (DQ31).
  - P. The rescue tube and manikin become separated after the rescue tube has been secured correctly around the manikin (DQ33).
  - Q. Touching the finish wall/edge without the rescue tube and manikin in place (DQ34).
  - R. Failure to touch the finish wall/edge (DQ14)
- .

## 14. LINE THROW (12.5M)

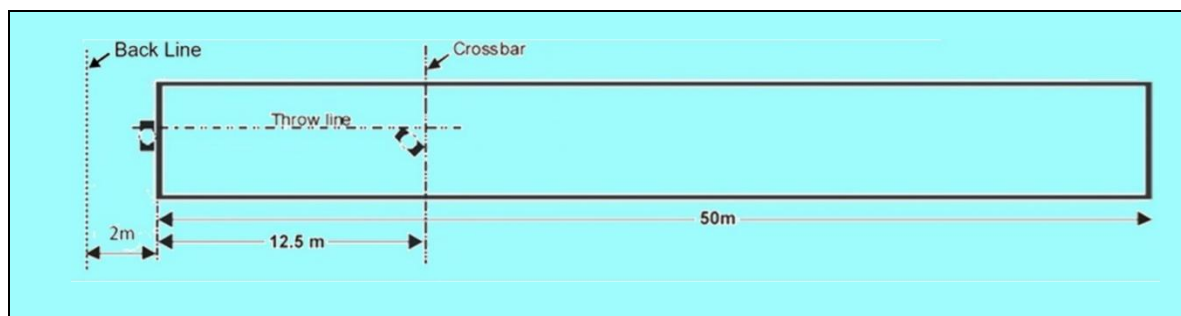

FIGURE 8: LINE THROW (12.5M)

### 14.1. Event description

In this event, the competitor (“rescuer”) throws an unweighted line/rope from a throw zone on the edge of the pool to a fellow team member (“victim”) located in the water on the near side of a crossbar located 12.5m distant. The rescuer pulls (“hauls in”) their victim back to the finish wall/edge of the pool.

At the start signal the rescuer shall retrieve the rope and throw it back to the victim. If it is a fair throw the victim grasps the rope and then the competitor hauls the victim back to the finish wall of the pool.

Victims may wear swim goggles.

#### A. Throw Zone:

The throw zone is the area bounded by each team’s allotted lane. It extends from the vertical edge of the pool wall to the front of a team’s lane and is defined at the sides by an unmarked extended line in the middle of the lane ropes on each side of a team’s lane and to the edge of the pool deck or raised platform.

The back line of the throw zone is 2m beyond the vertical edge of the pool wall to allow for an unimpeded throw and the haul in.

The back line is to be marked as a reference point for teams and Officials. Backward movement by the rescuer within this area is not a disqualification providing that the rescuer maintains at least one foot wholly within the marked 2m back line of their throw zone, either on the ground or in the air above their throw zone during the haul in until the victim has touched the finish wall/edge.

**Note:** Dependent on pool design, the 2m back line may extend from the pool edge beyond the width of a raised pool end or bulkhead/pontoon i.e., any bulkhead/pontoon forms part of the 2m from the pool edge. It is permitted for the rescuer to place their feet against a raised edge of the pool at any time during the event provided that it is within the throw zone.

#### B. Time Limit:

Rescuers must make a fair throw and haul in the victim to the finish wall/edge within the 45 second time limit permitted for this event.

If a throw falls short or outside of the allocated lane, rescuers may recover the line/rope and throw again as often as is necessary to secure the victim with the 45 second time limit.

Rescuers who fail to get the victim to the finish wall/edge before the 45 second acoustic completion signal shall be designated as “Did Not Finish” (DNF).

#### C. The Start:

Preparing for the start: On the first whistle, competitors (i.e., rescuer and victim) prepare for the start.

The rescuer holds one end of the throw line/rope in one hand.

The victim takes the other end of the line/rope, enters the water, and proceeds to the near side of the crossbar. The line/rope is then extended between the victim and the rescuer. The surplus line/rope is extended beyond the 12.5m crossbar mark. The surplus line/rope may be passed either over or under the crossbar.

On the second whistle, rescuers take their positions for the start without undue delay. When all competitors have assumed their starting positions and are stationary, the Starter shall give the command “Take your marks.” When all rescuers and victims are stationary, the Starter gives the acoustic starting signal.

**Note:** No practice throws are permitted prior to the start.

Starting position: The rescuer is free to adopt a position within their throw zone for the start and may hold the line/rope in one or two hands. The end of the throw line/rope must be held in one hand.

**Note 1:** A kink in the line/rope between the rescuer and victim is permitted but no loops in the line are permitted. A kink but no loop in the line/rope between the two hands of the rescuer is also permitted.

**Note 2:** It is not permitted to wrap the line/rope around the hand that holds the end of the rope.

The victim, who is located on the near side of the rigid crossbar in their allotted lane, grasps the crossbar with one or two hands. The victim is not required to be in contact with the throw line/rope at the start of the event.

The rescuer shall retrieve the line/rope, throw it back to the victim (who grasps it), and hauls the victim through the water until the victim touches the finish wall/edge.

#### D. Fair Throw:

A fair throw is one where a victim is able to grasp the thrown rope/line with their hand but only within their designated lane.

**Note:** A thrown line/rope lying over a lane rope is not within a designated lane is not a fair throw. However, if some part of this thrown line/rope is lying within a team's designated lane and the victim is able to grasp that part of the throw line/rope that is within their designated lane, it is a fair throw.

#### E. The Victim Grasping the Line/Rope:

The victim may only grasp the line/rope or the haul in if it is a fair throw.

The victim can slide their hand anywhere along the crossbar but must be grasping the crossbar when touching the line/rope with any part of their body and when grasping the line/rope.

As long as victims remain entirely within their designated lane and they do not release their grasp on the crossbar, they may use their foot or other part of the body to manoeuvre the throw line/rope within their lane to a position where they can grasp the line/rope with their hand.

There is no penalty for pulling on the rigid crossbar while attempting to reach the throw line/rope.

**Note:** The victim may release their contact with the crossbar after the starting signal without penalty, but they must be grasping the crossbar with their hand when using any part of their body to attempt to gather or to grasp the line/rope with the other hand.

#### F. The Haul In and Finish:

While being hauled in to the finish edge, victims must be on their front grasping the throw line/rope with both hands. Victims are not permitted to "climb" the throw line/rope hand-over-hand. For safety reasons, victims may release the line/rope with one hand for the sole purpose of touching the wall/edge. This will not result in disqualification.

**Note 1:** "Climbing" the rope is defined as the victim moving up the rope using their hands towards the end held by the rescuer.

Line/Rope rescuers must haul in their victim using their arms. While hauling in their victim to the finish a backward movement within the 2m backline is permitted, Rescuers are not permitted:

- To walk or run with the throw line/rope grasped in their hands.
- Have the throw line held around any part of their body while hauling in the victim.
- To move backwards beyond the marked 2m back line while hauling in the victim to the finish wall/edge.

**Note:** Any backward movement within the 2m back line mark is not a disqualification provided that the rescuer maintains at least one foot wholly within the marked 2m back line of their throw zone, either on the ground or in the air above their throw zone until the victim has touched the finish wall/edge.

The team will not be disqualified if the rescuer leaves their Throw Zone after their victim touches the finish wall/edge but the team will be disqualified if they cause any interference to other teams in the race.

After touching the finish edge the victim must not exit the water and is to remain in their lane. The team will be disqualified if the victim attempts to climb out of the water beyond their waist or sit on the pool edge or lane rope before the acoustic signal is given by the designated Official for the completion of the race.

F. Throw Zone Conditions:

Rescuers may not interfere with other competitors.

Line/Rope rescuers may reach to retrieve a line/rope dropped outside the throw zone or in the pool as long as there is no interference with another competitor.

Rescuers who enter (or fall into) the water shall be disqualified.

For the purposes of judging competitors are required to remain within their lane while hauling in the victim. However, other than judging the 2m back line during the haul in until the victim has touched the wall to record a finish result, the focus is not on the placement of feet within a defined area but, rather, on the team not interfering with any other team competing in the event.

**Note:** Remaining in the throw zone as defined means that the rescuer maintains at least one foot wholly within the inside edge of their throw zone, either on the ground or in the air above their throw zone until the victim has touched the finish wall/edge.

#### 14.2. Equipment

- A. Throw line/rope: See Section 8. The throw line/rope must be between 16.5m and 17.5m in length. Competitors must use the throw lines/ropes supplied by Organisers.
- B. The rigid crossbar is positioned on the surface across each lane 12.5m from the starting end of the pool. A tolerance of plus 100mm and minus 0.00mm in each lane is allowed.

#### 14.3. Disqualification

In addition to Section 2 and those rules outlined in S3-1 to 3-2, the following behaviour shall result in disqualification:

- A. Line/Rope rescuer executing practice throw(s) (DQ52).
- B. Victim not keeping a grasp on the crossbar with their hand when using any part of their body to gather or to grasp the line/rope for the haul in to the finish wall/edge. (DQ45).
- C. Victim grasping the throw line/rope outside the lane (DQ48).
- D. Victim not on their front while being hauled in to the finish wall/edge (DQ49).
- E. Victim not holding the throw line/rope with both hands while being hauled in to the finish wall/edge (victim may release the line/rope with one hand for the sole purpose of touching the wall/edge) (DQ50).
- F. Victim “climbing” the throw line/rope hand-over-hand (DQ51).
- G. Line/Rope rescuer who, after the start signal and before their victim touches the finish wall/edge, exits their allocated throw zone (DQ46).
- H. Line/Rope rescuer not hauling in using their arms and walking or running with the line/rope grasped in their hands or held around any part of their body or hauling in beyond the 2m back line mark to return the victim to the pool finish wall/edge. (DQ47).
- I. Failure to touch the finish wall/edge (DQ14).

## 15. MANIKIN RELAY (4 X 25M)

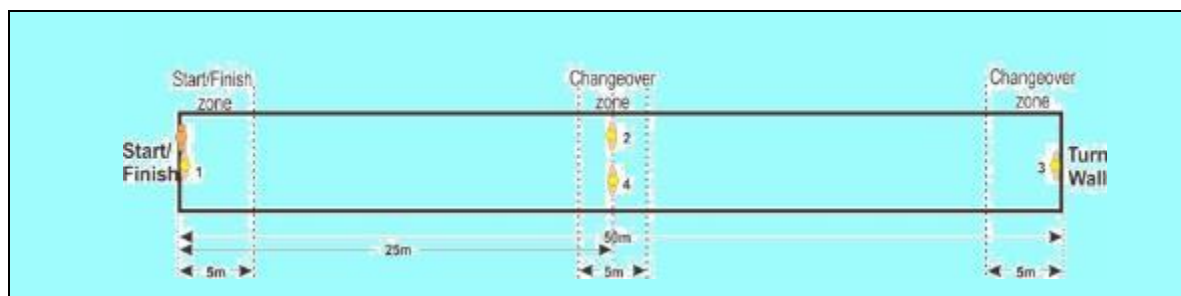

FIGURE 9: MANIKIN RELAY (4 X 25M)

### 15.1. Event description

Four competitors in turn carry a manikin approximately 25m each.

- A. On the first long whistle, all competitors enter the water. On the second long whistle, all competitors, without undue delay, prepare for the start.
- B. The first competitor is holding a manikin with one hand and/or arm and the start wall/edge or starting block with the other hand and the second, third, and fourth competitors are in the water at the 25m, 50m, and 75m marks, respectively.
- C. When all competitors have assumed their starting positions, the Starter shall give the command “Take your Marks.”
- D. When the first competitors are stationary, the Starter gives the acoustic starting signal.
- E. The first competitor: The first competitor carries the manikin with at least one hand and/or arm and passes it to the second competitor within the 5m changeover zone situated between the 22.5m and 27.5m mark.
- F. The second competitor: The second competitor carries the manikin with at least one hand and/or arm to touch the turning wall/edge and passes the manikin to the third competitor who is in contact with the turning wall/edge or starting block **with at least one hand**.
- G. The third competitor: The third competitor may touch or grasp the manikin with one hand before the second competitor touches the turning wall/edge or starting block **with at least one hand** until the second competitor has touched the turning wall/edge.
- H. **The third competitor carries the manikin with at least one hand and/or arm and passes it to the fourth competitor in the changeover zone between the 72.5m and 77.5m mark.**
- I. The fourth competitor: The fourth competitor completes the event by carrying the manikin with at least one hand and/or arm to touch the finish wall/edge with any part of the competitor’s body.
- J. Only the incoming and outgoing competitors may participate in the manikin exchange within their changeover zones. The incoming competitors may assist outgoing competitors, but only as long as the top of the manikin’s head remains within the changeover zones.
- K. The hand and/or arm of one competitor must be in contact with the manikin at all times.
- L. The start zone and relay changeover zones shall be indicated by flags, poles, or cones.
- M. Competitors involved in the exchange may push off the pool bottom in the changeover zone.
- N. In the start and in changeover zones competitors are not judged on “carrying the manikin” criteria (defined in S3-3) however competitors need to maintain contact with the manikin with at least one hand and/or arm at all times and including during the exchanges.  
**Note:** The standard “carrying the manikin” criteria (defined in S3-3) apply to the final relay competitor at the finish of the event.
- O. The manikin exchange must take place within the designated changeover zones, as judged by the top of the manikin’s head.
- P. **If practical, and under the direction of officials, the first second and third competitors may leave the water upon finishing their legs of the relay. Competitors should leave the water by crossing to the**

nearest side of the pool and without obstructing any other competitors. Competitors may not re-enter the water.

**Q.** The fourth competitors must not leave the water before the all clear signal is given.

### **15.2. Equipment**

Manikin: See Section 8. The manikin is completely filled with water and sealed. Competitors must use the manikins supplied by Organisers.

### **15.3. Disqualification**

In addition to Section 2 and those rules outlined in S3-1 to S3-3, the following behaviour shall result in disqualification:

- A. Using incorrect manikin carry technique as described in Section 3, point 3 Manikins (DQ19).
- B. Taking assistance from any pool fitting (e.g., lane rope, steps, drains or underwater hockey fittings) – not including the bottom of the pool (DQ17).
- C. The third competitor releasing contact with the turning wall/edge/starting block before the second competitor has touched the wall/edge (DQ37).
- D. The manikin changing hands before or beyond the designated changeover zone (DQ38).
- E. Assistance from a third competitor during the exchange between the incoming and outgoing competitors (DQ35).
- F. Releasing the manikin before the next competitor has grasped it (i.e., one hand and/or arm of each competitor must be in contact with the manikin) (DQ39).
- G. Not having the manikin in the correct carrying position before the top of the manikin's head passes the 5m line (DQ18).
- H. Releasing the manikin before touching the turning wall/edge or finish wall/edge (DQ21).
- I. Failure to touch the finish wall/edge (DQ14).
- J. A competitor re-entering the water after completing their leg of the relay (DQ44).
- K. One competitor completing two or more legs of the event (DQ36).

## 16. OBSTACLE RELAY (4 X 50M)



FIGURE 10: OBSTACLE RELAY (4 X 50M)

### 16.1. Event description

Four competitors in turn swim a distance of 50m under obstacles.

- A. The first competitor: With a dive start on an acoustic signal, the first competitor swims 50m freestyle passing under two obstacles.
- B. The second, third and fourth competitors: After the first competitor touches the turning wall/edge the second, third, and fourth competitors repeat the procedure in turn.
- C. All competitors must surface after the dive entry before the first obstacle and after passing under each obstacle. “Surfacing” means the competitor’s head breaks the surface of the water.

**Note:** “Breaking the surface” when swimming means that the competitor’s head must break the plane of the surface of the water.

- D. Competitors may push off the pool bottom when surfacing from under the obstacles.
- E. Swimming into or otherwise bumping an obstacle is not a behaviour that results in disqualification.
- F. If practical, and under the direction of officials, the first, second, and third competitors are to leave the water upon finishing their legs of the relay. Competitors should leave the water by crossing to the nearest side of the pool and without obstructing any other competitors. Competitors may not re-enter the water.

### 16.2. Equipment

Obstacles: See Section 8. Obstacles are fixed at right angles on lane ropes in a straight line across all lanes. The first obstacle is positioned 12.5m from the start wall with the second obstacle 12.5m from the opposite end. The distance between the two obstacles is 25m.

### 16.3. Disqualification

In addition to Section 2 and those rules outlined in S3-1 to S3.2, the following behaviour shall result in disqualification:

- A. Passing over an obstacle and not immediately returning over or under that obstacle and then passing under it (DQ11).
- B. Failure to surface after the dive entry or before and after passing under an obstacle. (DQ12).
- C. Taking assistance from any pool fitting (e.g., lane rope, steps, drains or underwater hockey fittings) when surfacing – not including the bottom of the pool (DQ17).
- D. Leaving the starting block before the previous competitor has touched the wall/edge (DQ37).
- E. Failure to touch the finish wall/edge (DQ14).
- F. A competitor re-entering the water after completing their leg of the relay (DQ44).
- G. One competitor repeating two or more legs of the event (DQ36).

## 17. MEDLEY RELAY (4 X 50M)

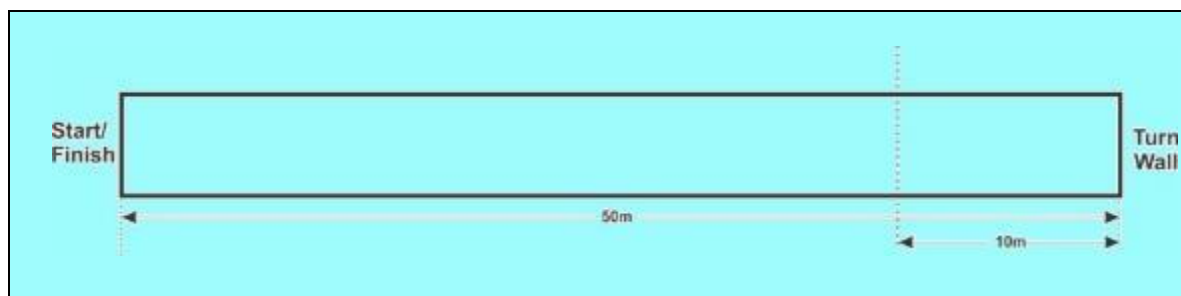

FIGURE 11: MEDLEY RELAY (4 X 50M)

### 17.1. Event description

- A. Four competitors in turn swim a distance of 50m undertaking different tasks.
- The first competitor: With a dive start on an acoustic signal, the first competitor swims 50m freestyle without fins. The first competitor must break the surface of the water before touching the turning wall/edge.
- Note:** “Breaking the surface” when swimming means that the competitor’s head must break the plane of the surface of the water.
- B. The second competitor: With a dive start after the first competitor touches the turning wall/edge, the second competitor swims 50m freestyle with fins. The second competitor does not need to surface before touching the turning wall/edge.
- C. The third competitor: With a dive start after the second competitor touches the turning wall/edge, the third competitor swims 50m freestyle without fins towing a rescue tube. The third competitor touches the turning wall/edge.
- Note:** Although the rescue tube and rescue tube line may be positioned at the competitor’s discretion for the changeover (including the line/rope being wrapped around their body, tucked into swimsuits, etc.), teams shall be disqualified if the rescue tube tow line/rope is tied/knotted or clipped within itself to intentionally shorten the line/rope prior to the commencement of a race.
- D. The fourth competitor: The fourth competitor (with fins) is in the water with at least one hand in contact with turning wall/edge or starting block, dons the harness. The fourth competitor may touch or grasp the rescue tube, its harness or line with one hand, before the third competitor has touched the turning wall/edge but must have at least one hand on the turning wall/edge or starting block until the third competitor touches the edge. The fourth competitor may push off the wall/edge with hand, arm, or feet.
- E. The third competitor, playing the role of “victim,” holds the rescue tube and/or clip with both hands while being towed 50m by the fourth competitor to the finish.
- F. The victim must have the correct hold with the rescue tube when the top of the “victim’s” head crosses the 10m line.
- Note 1:** The third and fourth competitors are permitted to stand/walk after touching the turning edge and before the victim’s head has passed the 10m line with the victim in contact with the rescue tube.
- Note 2:** Refer to the third competitor changeover - Teams shall be disqualified if the tow line/rope of the rescue tube is intentionally shortened prior to the commencement of the third competitor’s leg of the race for the purpose of towing the victim (e.g. looping **and** tying/knotting or clipping the line/rope).
- Note 3:** Competitors shall not be disqualified if the line of the rescue tube becomes wrapped around the victim or is otherwise shortened by a competitor during the conduct of a race.
- G. The victim may kick while being towed, but no other assistance is permitted.
- H. The victim must grip the main body of the rescue tube and/or clip – not the rope.
- I. The victim must hold onto the rescue tube and/or clip with both hands while being towed but may reposition their hands on the tube and/or clip during the tow without disqualification.
- J. The event is complete when the fourth competitor touches the finish wall/edge of the pool with the victim in contact with the rescue tube.

- K. If practical, and under the direction of officials, the first, second, and third competitors are to leave the water upon finishing their legs of the relay. Competitors should leave the water by crossing to the nearest side of the pool and without obstructing any other competitors. Competitors may not re-enter the water.

### 17.2. Equipment

- A. Rescue tube, swim fins: See Section 8. Competitors must use the rescue tubes supplied by Organisers.
- B. Starts with rescue tubes: For the third competitor's start, the rescue tube and rescue tube line may be positioned at the competitor's discretion, but within the competitor's allotted lane. Competitors should ensure a safe and correct position of rescue tube and line. The rescue tube remains unclipped throughout.
- C. Wearing rescue tubes: Rescue tubes must be donned correctly, either with the lanyard/harness over one or both shoulders, or over one shoulder and across the chest – at the competitor's discretion. Assuming the rescue tube was donned correctly, there is no cause for disqualification if the lanyard/harness falls down on the competitor's arm or elbow or is re positioned during the competitor's approach or tow.
- D. Towing the victim: Victims must be holding the rescue tube and/or clip correctly at the time the top of the victim's head passes the 10m line.
- E. Retrieving lost fins: Competitors may retrieve fins lost after the start and continue without disqualification as long as the rules governing manikins (if being used in the leg of the race) are not violated (see 3.3 Manikins). Competitors are not permitted to start again in another heat.
- F. Rescue Tube Defect: If in the opinion of the Chief Referee the rescue tube, line and/or harness (belt) presents a technical defect during the race, the Chief Referee may allow the competitor to start again in another heat but only if the rescue tubes for the event were supplied by the organising body and the rules required that the provided tubes must be used by all competitors.

### 17.3. Disqualification

In addition to Section 2 and those rules outlined in S3-1 to S3-3, the following behaviour shall result in disqualification:

- A. First competitor not surfacing after the dive entry and before touching the turning wall/edge. (DQ16).
- B. Leaving the starting block/releasing contact with the turning wall/edge/starting block before the previous competitor has touched the wall/edge (DQ37).
- C. The competitor clipping the rescue tube into the O-ring (DQ40).
- D. The victim holding the rescue tube by the rope (DQ41).
- E. The victim helping with arm movements or not holding the rescue tube and/or clip with both hands (DQ42).
- F. The victim not holding or losing the rescue tube (or clip) after passing the 10m line (DQ43).
- G. One competitor completing two or more legs of the event (excludes third competitor acting as victim) (DQ36).
- H. Failure to touch the finish wall/edge (DQ14).
- I. A competitor re-entering the water after completing their leg of the relay (DQ44).

## 18. POOL LIFESAVER RELAY (4 X 50M)

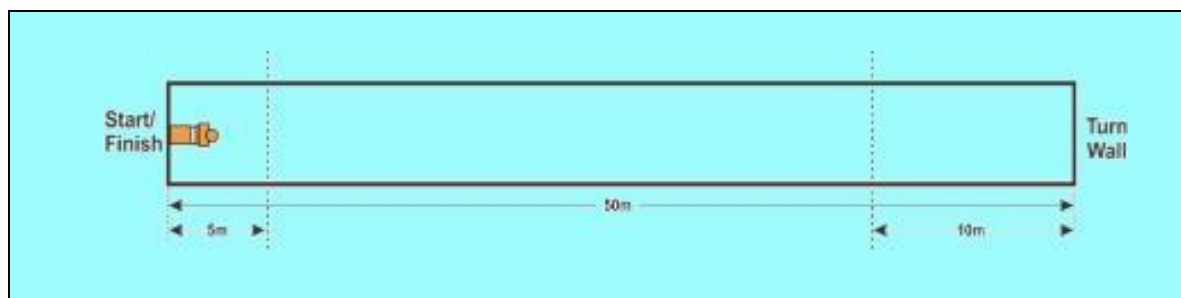

FIGURE 12: POOL LIFESAVER RELAY (4 X 50M)

### 18.1 Event description

Four competitors in turn swim a distance of 50m undertaking different tasks.

- A. The first competitor: With a dive start on an acoustic signal, the first competitor swims 50m freestyle without fins.

**Note 1:** The first competitor must break the surface of the water before touching the turning wall/edge.

**Note 2:** “Breaking the surface” when swimming means that the competitor’s head must break the plane of the surface of the water.

- B. The second competitor: With a dive start after the first competitor touches the wall/edge, the second competitor swims 50m with fins and dives to retrieve a submerged manikin. The second competitor does not need to touch the turning edge before (or after) passing the manikin to the third competitor.

**Note:** The second swimmer is permitted to swim the whole lap underwater before surfacing with manikin or may surface one or more times after the start and before diving to retrieve the manikin.

- C. The third competitor: The third competitor is waiting in the water (without fins) in contact with the turning wall/edge or starting block with at least one hand. The third competitor may touch or grasp the manikin with one hand and/or arm before the head of the manikin breaks the surface of the water. After the top of the manikin’s head breaks the surface of the water the third competitor releases their contact with the turning wall/edge or starting block. The second competitor is not required to touch the turning wall/edge when surfacing with the manikin, but the manikin must not be released by the second competitor until the third competitor has grasped it (i.e., the hand and/or arm of at least one competitor must be in contact with the manikin at all times). The third competitor then carries the manikin 50m with at least one hand and/or arm and touches the wall/edge before passing the manikin to the fourth competitor.

**Note:** Before the third competitor releases their contact with the turning wall/edge, the head of the manikin must have broken the surface of the water.

- D. The fourth competitor: The fourth competitor (with fins) is in the water with at least one hand in contact with the turning wall/edge or starting block. The fourth competitor may touch or grasp the manikin with one hand and/or arm before the third competitor has touched the turning wall/edge. The fourth competitor must not release contact with the turning wall or starting block until the third competitor has touched the turning wall/edge and the manikin must not be released by the third competitor until the fourth competitor has grasped it (i.e., one hand and/or arm of each competitor must be in contact with the manikin at all times). The fourth competitor then carries the manikin with at least one hand and/or arm to touch the finish wall/edge with any part of the competitor’s body.

- E. The incoming second and third competitors may assist their outgoing competitors, but only as long as the top of the manikin’s head remains within the changeover zones.

- F. Flags, poles, or cones shall indicate the changeover zones for the manikin carry legs:

- At the 2<sup>nd</sup> to 3<sup>rd</sup> competitor changeover - 5m from the pool wall.
- At the 3<sup>rd</sup> to 4<sup>th</sup> competitor changeover - 10m from the pool wall.

- G. Competitors must have the manikin in the correct carrying position as follows:

- Third competitor - 5m from the pool wall.
- Fourth competitor - 10m from the pool wall.

- H. Competitors may not release the manikin until the next competitor has grasped it (i.e., one hand and/or arm of each competitor must be in contact with the manikin).
- I. The third and fourth competitors are not judged on “carrying the manikin” criteria (see S3-3) within the changeover zones as judged by the top of the manikin’s head. Carrying the manikin criteria do apply within the finish zone at the end of the relay.
- J. The third and fourth competitors may push off the wall/edge with hand, arm, or feet after taking the manikin for their respective legs.
- K. The event is complete when the fourth competitor touches the finish wall/edge of the pool while still correctly carrying the manikin.
- L. **If practical, and under the direction of officials, the first, second, and third competitors are to leave the water upon finishing their legs of the relay. Competitors should leave the water by crossing to the nearest side of the pool and without obstructing any other competitors.** Competitors may not re-enter the water.
- M. Retrieving lost fins: Competitors may retrieve fins lost after the start and continue without disqualification as long as the rules governing manikins (if being used in the leg of the race) are not violated (see S3-3). Competitors are not permitted to start again in another heat.  
**Note:** For Lifesaving World Championships each team shall consist of two males and two females.
- N. Teams are permitted to select their own gender order.

## 18.2. Equipment

Manikin: See Section 8. The manikin is completely filled with water and sealed. Competitors must use the manikins supplied by Organisers.

Swim fins: See Section 8.

## 18.3. Disqualification

In addition to Section 2 and those rules outlined in S3-1 to S3-3, the following behaviour shall result in disqualification:

- A. The first competitor not surfacing after the dive entry and before touching the turning wall/edge (DQ16).
- B. Using incorrect manikin carry technique as described in 3.3 Manikins (DQ19).
- C. Taking assistance from any pool fitting (e.g., lane rope, steps, drains or underwater hockey fittings) – not including the bottom of the pool (DQ17).
- D. The third competitor releasing contact with the turning wall/edge during the changeover before the head of the manikin has broken the surface of the water (DQ53).
- E. The third competitor not having the manikin in a correct carrying position before the top of the manikin’s head passes the 5m line (DQ18).
- F. Assistance from a third competitor during the exchange between the incoming and outgoing competitors (DQ35).
- G. Releasing the manikin before the next competitor has grasped it (i.e., one hand and/or arm of each competitor must be in contact with the manikin) (DQ39).
- H. The fourth competitor not having the manikin in a correct carrying position before the top of the manikin’s head passes the 10m line (DQ23).
- I. Failure to touch the finish wall/edge (DQ14).
- J. One competitor completing two or more legs of the event (DQ36).
- K. With the exception of the third competitor, leaving the starting block/releasing contact with the turning wall/edge/ starting block before the previous competitor has touched the wall/edge (DQ37).
- L. Failure to touch the finish wall/edge (DQ14).
- M. A competitor re-entering the water after completing their leg of the relay (DQ44).

## 19. RESCUE TOW RELAY (4 X 50M)

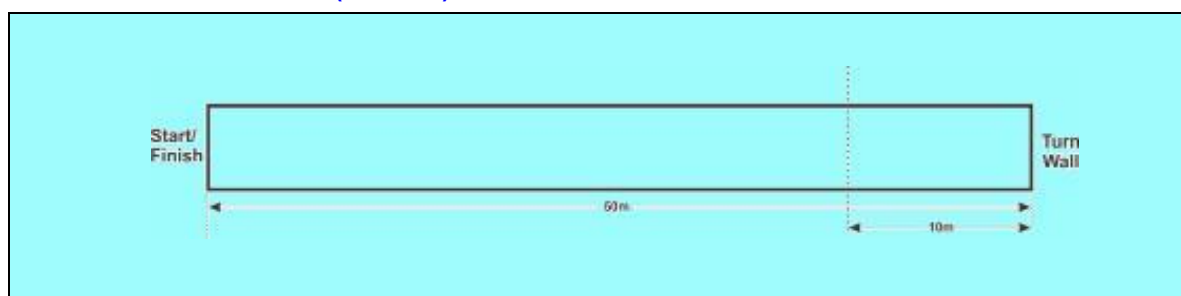

FIGURE 13: RESCUE TOW RELAY (4 X 50M)

### 19.1 Event description

Four competitors in turn swim a distance of 50m undertaking different tasks.

- A. First competitor: With a dive start on an acoustic signal, the first competitor swims 50m freestyle without fins. The first competitor must break the surface of the water before touching the turning wall/edge.

**Note:** "Breaking the surface" when swimming means that the competitor's head must break the plane of the surface of the water.

- B. Second competitor: With a dive start after the first competitor touches the wall/edge, the second competitor swims 50m freestyle with fins. The second competitor does not need to surface before touching the turning wall/edge.

- C. Third competitor: With a dive start after the second competitor touches the wall/edge, the third competitor swims 50m freestyle with fins towing a rescue tube. The third competitor (who plays the role of rescuer) touches the turning wall/edge. The third competitor does not need to surface before touching the turning wall/edge.

**Note:** Although the rescue tube and rescue tube line may be positioned at the competitor's discretion for the changeover (including the line/rope being wrapped around their body, tucked into swimsuits, etc.), teams shall be disqualified if the rescue tube tow line/rope is tied/knotted or clipped within itself to intentionally shorten the line/rope prior to the commencement of a race.

- D. Fourth competitor: The fourth competitor (playing the role of victim) is in the water with at least one hand in contact with the turning wall/edge or the starting block. The fourth competitor may touch or grasp the rescue tube, its harness or line with one hand before the third competitor has touched the turning wall/edge. The fourth competitor must not release contact with the turning wall or starting block until the third competitor has touched the turning wall/edge.

**Note 1:** The third competitor unintentionally touching the fourth competitor before the touching the turning wall/edge is not a disqualification.

**Note 2:** Standing or walking while clipping the rescue tube around the victim is not a disqualification provided that the victim is clipped into the rescue tube at the time the top of the victim's head passes the 10m line.

- E. As soon as the third competitor has touched the turning edge/wall of the pool, they can release contact with the turn edge/wall or starting block and the "clip in" into the rescue tube can commence.

- F. The rescuer and/or the victim secures the rescue tube around the victim's body under both arms and clipped to an O-ring.

- G. Both the rescuer and the victim must leave from the turning wall/edge. The victim must be in secured with the rescue tube clipped in around their body when the top of the "victim's" head crosses the 10m line.

**Note:** It is permitted for the rescuer and/or victim to push off from the turning wall.

- H. Victims must be clipped into the rescue tube at the time the top of the victim's head passes the 10m line.

- I. Outside of the 10m line the victim must be towed on their back and the victim cannot be towed in any other way than clipped into the rescue tube.

- J. The victim is permitted to assist by sculling under the surface of the water and kicking, but they must not swim backstroke or any other swim style with an out-of-water recovery.

**Note:** The victim repositioning their arms to a position in front of their head to streamline is not a disqualification.

- K. The event is complete when the rescuer touches the finish wall/edge of the pool with the victim clipped into the rescue tube.
- L. **If practical, and under the direction of officials, the first, second, and third competitors are to leave the water upon finishing their legs of the relay. Competitors should leave the water by crossing to the nearest side of the pool and without obstructing any other competitors.** Competitors may not re-enter the water.

### 19.2 Equipment

- A. Rescue tube, swim fins: See Section 8. Competitors must use the rescue tubes supplied by Organisers.
- B. Starts with rescue tubes: For the third competitor's start, the rescue tube and rescue tube line may be positioned at the competitor's discretion, but within the competitor's allotted lane. Competitors should ensure a safe and correct position of rescue tube and line. The rescue tube remains unclipped until the rescuer secures the victim.
- C. Wearing rescue tubes: Rescue tubes must be donned correctly, either with the lanyard/harness over one or both shoulders, or over one shoulder and across the chest – at the competitor's discretion. Assuming the rescue tube was donned correctly, there is no cause for disqualification if the lanyard/harness falls down on the competitor's arm or elbow or is re positioned during the competitor's approach or tow.
- D. Towing the victim: Rescuers must tow the manikin with rescue tube clipped around the victim's body. The rescue tube must be attached to the manikin by the time the top of the manikin's head passes the 10m line. Rescuers may go back into the 10m change over zone to re-secure the victim provided the top of the "victim's" head has not passed the 10m line.

**Note 1:** Refer to placement of fins and rescue tubes - Competitors shall be disqualified if the tow line/rope of the rescue tube is intentionally shortened by a competitor prior to the commencement of a race for the purpose of towing the victim (e.g. looping **and** tying/knotting or clipping the line/rope).

**Note 2:** Competitors shall not be disqualified if the line of the rescue tube becomes wrapped around the Victim or is otherwise shortened by a competitor during the conduct of a race.

- D. Towing the victim: Rescuers must tow the victim with rescue tube clipped around the victim's body.
- E. Retrieving lost fins: Competitors may retrieve fins lost after the start and continue without disqualification as long as the rules governing the towing of victims (if being used towed in the leg of the race) are not violated (see S3-3). Competitors are not permitted to start again in another heat.
- F. Rescue Tube Defect: If in the opinion of the Chief Referee the rescue tube, line and/or harness (belt) presents a technical defect during the race, the Chief Referee may allow the competitor to start again in another heat but only if the rescue tubes for the event were supplied by the organising body and the rules required that the provided tubes must be used by all competitors.

### 19.3 Disqualification

In addition to Section 2 and those rules outlined in S3-1 to 3-4, the following behaviour shall result in disqualification:

- A. The first competitor not surfacing after the dive entry and before touching the turning wall/edge (DQ16)
- B. Leaving the starting block/releasing contact with the turning wall/edge/starting block before the previous competitor has touched the turning wall/edge. (DQ37)
- C. Taking assistance from the pool bottom when securing the rescue tube around the victim (except where the minimum pool depth allows the athlete to stand). (DQ 8)
- D. Taking assistance from any pool fitting (e.g., lane rope, steps, underwater hockey fittings) when fixing the rescue tube around the victim except where the minimum pool depth allows the competitor to stand/walk while securing a rescue tube around the victim provided the top of the victim's head has not passed the 10m line (DQ24).
- E. The competitor (rescuer) clipping the rescue tube into the O-ring before touching the turning edge/wall. (DQ28)
- F. The rescue tube not being secured around the victim (judged at the top of the victim's head) before passing the 10m line. (DQ30)

- G. Pushing or carrying, instead of towing, the manikin (DQ31).
- H. The line of the rescue tube being intentionally shortened by a team prior to the commencement of a race for the purpose of towing the victim (DQ32)
- I. The victim becoming detached from the rescue tube (other than a technical defect with the tube - see tube defect note) after passing the 10m line and prior to the rescuer touching the finishing edge/wall. (DQ33)
- J. The victim not being towed on their back and clipped into the rescue tube and behind the rescuer. (DQ54)
- K. The victim swimming backstroke or any other swim style with an out-of-water arm recovery. (DQ55)  
**Note:** The victim sculling under the water to assist the with tow or the victim repositioning their arms to a position in front of their head to streamline is not a disqualification.
- L. The victim touching the finish edge/wall before the rescuer. (DQ56)
- M. Touching the finish wall/edge without the rescue tube and victim in place (DQ34).
- N. One competitor completing two or more legs of the event. (DQ36)
- O. Failure to touch the finish wall/edge. (DQ14)
- P. A competitor re-entering the water after completing their leg of the relay (DQ44).

## 20. DISQUALIFICATION CODES FOR POOL EVENTS

Code and Disqualification	Events
1. Not completing the event in accordance with the event description or general rules.	All events
2. A competitor or team may be disqualified if a competitor, team, or handler is deemed to have competed unfairly. Examples of “competing unfairly” include: <ul style="list-style-type: none"> <li>• Committing a doping or doping-related infraction.</li> <li>• Impersonating another competitor.</li> <li>• Attempting to defeat the ballot or draw for events or positions.</li> <li>• Competing twice in the same individual event.</li> <li>• Competing twice in the same event in different teams.</li> <li>• Purposely interfering with a course to gain advantage.</li> <li>• Jostling or obstructing another competitor or handler so as to impede their progress.</li> <li>• Receiving physical or material outside assistance (other than verbal or other direction).</li> <li>• Participating contrary to the spirit of the competition (as described in the code of fair play).</li> </ul>	All events
3. Competitors may not be permitted to start in an event if they are late reporting to the Marshalling Area. This may be noted as a “did not start” (DNS) or similar on result sheets.	All events
4. A competitor or team absent from the start of an event shall be disqualified except for the A- or B-final. This may be noted as a “did not start” (DNS) or similar on result sheets.	All events
5. Activities that result in wilful damage to the venue sites, accommodation sites or the property of others will result in disqualification of the individuals involved from competition.	All events
6. Abuse of Officials resulting in disqualification from the competition.	All events
7. Using sticky, tacky, or adhesive substances (liquid, solid or aerosol) on hands or feet, or on the manikin or rescue tube to improve grip or push off the bottom of the pool.	All events
8. Taking assistance from the pool bottom except where specifically allowed (i.e. Obstacle Swim and Relay, 4 x 25m Manikin Relay, Manikin Tow, Super Lifesaver, Manikin Lifesaver Medley, Medley Relay, Rescue Tow Relay).	All events
9. Leaving the water after an event before permission is given by the Official.	All events
10. Initiating a starting motion before the starting signal has been given.	All events
11. Passing over an obstacle without immediately returning over or under that obstacle and then passing under it.	Obstacle Swim Obstacle Relay
12. Failure to surface after the dive entry or after a turn before and after passing under an obstacle.	Obstacle Swim Obstacle Relay
13. Failure to touch the wall/edge during the turn.	Obstacle Swim
14. Failure to touch the finish wall/edge.	All events
15. Not surfacing before diving to the manikin.	Manikin Carry Manikin Lifesaver Medley
16. Competitor not surfacing after the dive entry and before touching the 50m turning wall/edge	Rescue Medley Super Lifesaver

Code and Disqualification	Events
<p><b>Note:</b> For Relay events this applies only to this is the first competitor.</p>	<p>Medley Relay                      Pool Lifesaver Relay                      Rescue Tow Relay</p>
<p>17. Taking assistance from any pool fitting (e.g., lane rope, steps, drains or underwater hockey fittings) when surfacing with the manikin (as applicable for the event) – not including, where specified, the bottom of the pool.</p>	<p>Manikin Carry                      Rescue Medley                      Manikin Carry with Fins                      Super Lifesaver                      Manikin Lifesaver                      Medley                      Manikin Relay                      Obstacle Relay                      Pool Lifesaver Relay</p>
<p>18. Not having the manikin in a correct carrying position before the top of the manikin’s head passes the 5m line (for carries without fins).</p>	<p>Manikin Carry                      Manikin Relay                      Rescue Medley                      Super Lifesaver                      Manikin Lifesaver                      Medley                      Pool Lifesaver Relay</p>
<p>19. Using an incorrect manikin carrying technique (as described in 1-3).</p>	<p>Manikin Carry                      Manikin Carry with Fins                      Rescue Medley                      Super Lifesaver                      Manikin Lifesaver                      Medley                      Manikin Relay                      Pool Lifesaver Relay</p>
<p>20. Towing the manikin with the face below the surface.</p>	<p>Manikin Tow with Fins                      Super Lifesaver                      Manikin Lifesaver                      Medley</p>
<p>21. Releasing the manikin before touching the finish wall/edge or the turning wall/edge.</p>	<p>Manikin Carry                      Manikin Carry with Fins                      Rescue Medley                      Super Lifesaver                      Manikin Relay                      Manikin Lifesaver                      Medley</p>
<p>22. Surfacing after turning and before lifting the manikin.</p>	<p>Rescue Medley</p>
<p>23. Not having the manikin in the correct carrying position before the top of the manikin’s head passes the 10m line (for carries with fins).</p>	<p>Manikin Carry with Fins                      Pool Lifesaver Relay</p>
<p>24. Taking assistance from any pool fitting (e.g., lane rope, steps, underwater hockey fittings) when fixing the rescue tube around the</p>	<p>All Events</p>

Code and Disqualification	Events
manikin (or victim in the Rescue Tow Relay)) except where the minimum pool depth allows the competitor to stand/walk while securing a rescue tube around the manikin (or victim) (i.e. Manikin Tow, Super Lifesaver, Manikin Lifesaver Medley, Rescue Tow Relay).	
25. At 50m / 150m, competitor not touching the pool wall/edge before intentionally touching manikin.	Manikin Tow with Fins Super Lifesaver Manikin Lifesaver Medley
26. Manikin handler releasing the manikin before the competitor touches the turning wall/edge).	Manikin Tow with Fins Super Lifesaver Manikin Lifesaver Medley
27. Manikin handler intentionally entering the water during the event or entering the water and interfering with the performance of another competitor or interfering with the judging of the event.	Manikin Tow with Fins Super Lifesaver Manikin Lifesaver Medley
28. Competitor clipping the rescue tube into the O-ring before touching the turning wall/edge.	Manikin Tow with Fins Super Lifesaver Manikin Lifesaver Medley Rescue Tow Relay
29. Incorrect securing of the rescue tube around the manikin (i.e., not around body and under <b>or on the</b> arms and not clipped to an O-ring).	Manikin Tow with Fins Super Lifesaver Manikin Lifesaver Medley
30. Not securing the rescue tube around the manikin/victim within the 10m change-over zone (judged at the top of the manikin's head).	Manikin Tow with Fins Super Lifesaver Manikin Lifesaver Medley Rescue Tow Relay
31. Pushing or carrying, instead of towing the manikin.	Manikin Tow with Fins Super Lifesaver Manikin Lifesaver Medley Rescue Tow Relay
32. The line of the rescue tube being intentionally shortened by a competitor prior to the commencement of a race for the purpose of towing the manikin/victim.	Manikin Tow with Fins Super Lifesaver Manikin Lifesaver Medley Medley Relay Rescue Tow Relay
33. The manikin/victim becoming detached from the rescue tube (other than a technical defect with the tube – see tube defect note) after passing the 10m line and prior to the rescuer touching the finishing edge/wall.	Manikin Tow with Fins Super Lifesaver Manikin Lifesaver Medley Rescue Tow Relay

Code and Disqualification	Events
34. Touching the finish wall/edge without the rescue tube and manikin/victim in place.	Manikin Tow with Fins Super Lifesaver Manikin Lifesaver Medley
35. Assistance from a third competitor during the exchange between the incoming and outgoing competitors.	Manikin Relay Pool Lifesaver Relay
36. One competitor repeating two or more legs of the event.	Obstacle Relay Manikin Relay Medley Relay Pool Lifesaver Relay Rescue Tow Relay
37. Leaving the starting block/releasing contact with the turning wall/edge/ starting block before the previous competitor has touched the wall/edge. <b>Note:</b> The second competitor in the Pool Lifesaver Relay is not required to touch the turning wall/edge before or following surfacing with the manikin. However, the third competitor must not release contact with the turning wall/edge until the head of the manikin has broken the surface of the water and they have grasped the manikin.	Obstacle Relay Manikin Relay Medley Relay Pool Lifesaver Relay Rescue Tow Relay
38. The manikin changing hands before or beyond the designated changeover zone	Manikin Relay
39. Releasing the manikin before the next competitor has grasped it (i.e., one hand and/or arm of each competitor must be in contact with the manikin).	Manikin Relay Pool Lifesaver Relay
40. The competitor clipping the rescue tube into the ring.	Medley Relay
41. The victim holding the rescue tube by the rope.	Medley Relay
42. The victim helping with arm movements or not holding the rescue tube and/or clip with both hands.	Medley Relay
43. The victim not holding or losing the rescue tube (or clip) after passing the 10m line.	Medley Relay
44. A competitor re-entering the water after completing their leg of the relay.	Obstacle Relay Manikin Relay Medley Relay Pool Lifesaver Relay Rescue Tow Relay
45. Victim not keeping a grasp on the crossbar with their hand when using any part of their body to gather or to grasp the line for the haul in to the finish wall/edge.	Line Throw
46. Line/Rope Thrower who, after the start signal and before their victim touches the finish wall/edge, exits their allocated throw zone.	Line Throw
47. Line/Rope Thrower not hauling in using their arms and walking or running with the line/rope grasped in their hands or held around any part of their body or hauling in beyond the 2.0m back line mark to return the victim to the pool finish wall/edge).	Line Throw
48. Victim grasping the throw line/rope outside their lane.	Line Throw
49. Victim not on their front while being hauled in to the finish wall/edge.	Line Throw

Code and Disqualification	Events
50. Victim not holding the throw line/rope with both hands while being hauled in to the finish wall/edge (victim may release the line with one hand for the sole purpose of touching the wall/edge).	Line Throw
51. Victim “climbing” the throw line/rope hand-over-hand.	Line Throw
52. Line/Rope thrower executing practice throws.	Line Throw
53. The third competitor releasing contact with the turning wall/edge during the changeover before the head of the manikin has broken the surface of the water.	Pool Lifesaver Relay
54. The victim not being towed on their back and clipped into the rescue tube and behind the rescuer.	Rescue Tow Relay
55. The victim swimming backstroke or any other swim style with an out-of-water arm recovery. <b>Note:</b> The victim sculling under the water to assist the with tow or the victim repositioning their arms to a position in front of their head to streamline is not a disqualification.	Rescue Tow Relay
56. The victim touching the finishing edge/wall before the rescuer.	Rescue Tow Relay

**Note:** In the Line Throw event failure to get the victim to the finish wall/edge before the 45-second acoustic completion signal shall be designated as a DNF, not a DQ.



**World Water Safety  
INTERNATIONAL LIFE SAVING FEDERATION**

## **ILS COMPETITION RULE BOOK**

### **SECTION 4 BEACH AND OCEAN EVENTS**



**2025 EDITION  
(Revised May 2026)**

## **SECTION 4 BEACH AND OCEAN EVENTS**

The following beach and ocean events are described in this section:

- Surf Race
- Surf Teams Race
- Rescue Tube Rescue
- Rescue Tube Race
- Run-Swim-Run
- Beach Flags
- Beach Sprint
- Beach Relay
- Beach Run – 2km and 1km
- 3 x1km Beach Run Relay
- Surf Ski Race
- Surf Ski Relay
- Board Race
- Board Relay
- Board Rescue
- Oceanman/Oceanwoman (and Olympic “M” format variation)
- Oceanman/Oceanwoman Relay
- Ocean Lifesaver Relay Mixed (Oceanman/Oceanwoman Relay variation)

### **1 GENERAL CONDITIONS FOR BEACH AND OCEAN COMPETITION**

Team management and competitors are responsible for being familiar with the competition schedule, and with the rules and procedures governing events.

- A. Competitors may not be permitted to commence in an event if they are late reporting to the marshalling area. To assist the Organisers in determining how many heats may be required, events may be marshalled the day before or at the start of the day the event is scheduled.
- B. A competitor or team absent from the start of an event shall be disqualified.
- C. Unless specifically provided for, no artificial enhancements to propulsion may be used in competition (e.g., hand webs, armbands).
- D. The use of wax or similar substances to assist the competitor in maintaining the grip on or contact with boards or surf skis or paddles is permitted in ocean events.
- E. Body tape used for preventative, medical, therapeutic or kinesiology purposes is allowed at the discretion of the Chief Referee (or the Chief Referee’s designate) as long as it does not provide a competitive advantage.
- F. Video cameras may be mounted on boards and surf skis as long as such devices conform to the requirements specified in S8 - 4 video cameras may not be worn by or otherwise attached to a competitor from start to finish of a race.
- G. All individual competitors and competitors from the same team shall wear their Official team swim caps or helmets (if worn in craft events) in all events. Ocean event caps, securely fastened under the chin, must be worn on competitors’ heads at the start of each race and at the start of each leg of a relay race.
- H. A competitor shall not be disqualified if the cap is displaced or lost after the start of a race provided that Officials could identify that the competitor correctly completed the race.
- I. Competition courses: Protests against the course will only be accepted prior to the start of each event or race.
  - All courses shall be measured, set, and aligned to the Chief Referee’s satisfaction ensuring as far as possible that all lanes have fair and equal conditions.
  - The ILS Event Management Committee and Chief Referee may authorise adjustments to course set-ups to ensure the safety, fair judging, and efficient conduct of the event (e.g., distances, number of lanes or buoys, number of competitors per race). Any course changes must be communicated to competitors prior to the start of the race (e.g., at the team managers briefing, in the Marshalling Area, or at the start).

- The use of colour-coded buoys and flags is recommended to guide competitors accurately through the required courses.
  - Buoy distances shall be measured from the end of knee-depth water at low tide mark. However, distances may vary depending upon beach conditions and safety factors. Adjustment of the buoys may be necessary during the competition if they move out of alignment.
  - Competitors in craft events may pass through the swimming buoys on their craft on the understanding that they are solely responsible if the buoys cause an impediment to their progress.
- J. Competitors and Officials must leave the designated competition area when not competing or officiating. The competition area may be defined as the section of the beach encompassed by a line or fence, or a direct line to the water from the extreme ends of a line or fence or other designated areas as specified by the Chief Referee.
- K. Finish Judges order-of-finish decisions are not subject to protest or appeal.
- L. Start decisions by the Starter or Chief Referee (or Chief Referee's designate) are not subject to protest or appeal.
- M. Luck of prevailing conditions: No protest or appeal will be entertained when an incident is caused by the prevailing conditions (see S2-7).

## 2 THE START

### 2.1 Prior to the start

- A. A Marshall shall:
- Place competitors in the order as drawn for all heats and or finals.
  - Accompany competitors and their required equipment to the starting area and ensure that competitors are positioned in proper order.
- B. Prior to the start of each race, designated technical Officials shall:
- Check that all Officials are in position.
  - Check that competitors have proper attire and caps for a legal start.
  - Check that equipment and course markers are in position.
- C. A designated Official e.g., Sectional Referee shall signal the Starter that the competitors are under the Starter's control.

### 2.2 The Starter

The Starter shall:

- A. Have sole jurisdiction over the competitors from the time of the signal until the race has started.
- B. Position himself or herself so as to have full visual control over all competitors during the start.
- C. Ensure that the start for all races is consistent and fair.
- D. Disqualify competitors for false starts (or in Beach Flags, eliminate competitors).

### 2.3 Start procedures

The starting of events is a three-step process commencing with a signal or command that indicates "Take Your Marks" followed by a signal or command that indicates "Set" and then followed by a start signal or command that indicates "Go."

The start procedure may be clarified at the Team Managers Briefing. Competitors may also be advised of the start commands to be used prior to the commencement of the first round of each event.

Care must be taken by Officials not to elongate the start process with unnecessary delays or by adding additional steps.

For a surf race or other similar events that commence from a line in the sand or cord on the beach, a verbal command such as "Competitors place your foot on or behind the Line" is equivalent to "Take your Marks." The next verbal command may be "Set" or "Face the Water," or "You are in the starters hands," or similar. The start ("Go") signal is then given by such means as a starting gun, air horn, whistle, or other appropriate means. The starter holding the gun or horn in the air, or placing in the whistle in their mouth, also provides a visual cue that a start is imminent.

**Note:** The definition of foot includes any part of the foot, heel, and/or toes.

Similarly for an event that commences in the water such as a surf ski race, the verbal command for “competitors to enter the water” is equivalent to “Take your Marks.” The next verbal command may be “Set” or “*You are in the Starter’s Hands*” or similar and/or an Official holding a signal flag aloft to indicate that a start is imminent. The “Go” command may be given using a starting gun, air horn, whistle, or other appropriate means. The starter holding the gun or horn in the air, or placing in the whistle in their mouth, may also provide a visual cue that a start is imminent.

For the Beach Sprint, the commands shall simply be the verbal command of “Take Your Marks” followed by the verbal command that indicates “Set” and then followed by the start (“Go”) signal that is usually a starting gun, air horn, electronic beeper, or whistle.

See also the individual event descriptions for the start procedures for Beach Flags, Surf Boat, and IRB events.

After the start, competitors in swim, board, surf ski (if a dry start), and multi-discipline events may enter the water within the confines of the competition arena at their own discretion, providing there is no interference to other competitors.

In relay or multi-discipline events, after completion of the first leg, the competitor entering the water in second or subsequent legs shall be deemed to be at fault if the progress of a competitor coming from the water is impeded.

## 2.4 Notes

- A. The duty of the Starter and Check Starter is to ensure a fair start. If the Starter or Check Starter decides that a start is not fair, for any reason, including technical or equipment fault, surf conditions, or other matters not caused by competitors, the competitors should be called back, and the start process shall recommence.
- B. While every endeavour should be made by the starter to affect an even and fair start, the decision to “go” on the start signal rests with the competitor or team. If there is no recall by the starter or the Check Starter(s) or the Chief Referee, no protest shall be allowed on the start.
- C. Competitors shall be disqualified if they “initiate a starting motion” prior to the starting signal. Involuntary movement by itself e.g., a muscle twitch or wash from waves for in-water starts is not a disqualification. Anticipating the starting signal and initiating a starting motion is a disqualification.
- D. The Starter and Check Starter use their discretion in determining whether a competitor – or more than one competitor – has commenced a starting motion. Commonly, the early starting motion of one competitor causes movement by other competitors. Such movements by the other competitors are not a DQ.
- E. The Starter’s or Check Starter’s decisions on starts are not subject to protest or appeal.

## 2.5 Start lines

- A. Start lines may be designated by:
  - A brightly coloured cord between two poles.
  - A line drawn on the sand between two poles.
  - A line of sight between two poles or otherwise as determined by the Starter.
- B. At the start, competitors’ feet shall be on or behind the start line (whether a cord, drawn on the sand or line of sight) but parts of the body may overhang the line.
- C. In events where a line is drawn and beach sprint type start is utilised, feet and fingers shall be on or behind the line except where an upright starting position is adopted. In such circumstances, competitors’ feet shall be on or behind the line, but parts of the body may overhang the line.
- D. In events such as a board race where a line is drawn or a cord designates the start line, a part of the board held by competitors may be over the start line, but it must be at right angles to the line or at an angle to accommodate prevailing conditions. Where a board is placed on the beach, it shall be placed with the hull flat on the beach (i.e. no sand other mounds underneath the board) at 90 degrees, and with the nose of the Board on the shoreward side of the start or changeover line.
- E. In surf boat and/or surf ski events where a line of sight is used with craft in the water, the bow of the craft shall be on or behind the line and at 90 degrees to the line or at an angle to accommodate the prevailing conditions.

## 2.6 Disqualification

- A. The one-start rule shall be used in all events.

- B. The first competitor or team that initiates a starting motion after assuming a final set position and before the starting signal shall be disqualified, except for Beach Flags in which the competitor shall be eliminated (DQ7).
- C. If the starting signal sounds before the disqualification is declared, the competitors shall be called back and start again.
- D. The signal to call back the competitors shall be the same as the starting signal but repeated.
- E. Any competitor who is disqualified for a false start shall not be permitted to continue in the race and must withdraw from the start line.
- F. All competitors who fail to comply with the Starter's commands within a reasonable time shall be disqualified (DQ8).
- G. Any competitor who, after the Starter's first command, disturbs others in the race through sound or otherwise, may be disqualified or eliminated (in the case of Beach Flags) (DQ9).

### 2.7 Changeovers and tagging in relays

- A. Exchanges or changeovers in relay events shall be affected by a competitor "tagging" the next team member unless otherwise provided (see Beach Relay).

In tagging, one competitor uses either hand to visibly touch the other competitor on the hand or other part of the body. All tags must be performed above the water surface so that they are visible.
- B. The outgoing competitor shall be positioned with feet on, or on the shoreward side of, the changeover line except for Ski Relay and Ski leg of Ocean Relay (where they are in the water).
- C. Competitors in relay events **should** start their leg of the race from the position or lane allotted by the Marshall. If competitors do not start from their designated lane or position **when directed by an official**, the team **may be** disqualified.

## 3. THE FINISH

- A. In events where competitors run across a finish line, they must cross the line on their feet and in an upright position (i.e., not fall across the line). The finish is judged on the chest of the competitor when crossing the finish line.

**Note:** Falling across the line is not deemed to have finished the event. For the avoidance of doubt one foot must be grounded on or over the finish line for the competitor to be deemed to have correctly finished a race.

- B. In events with in-water finishes such as surf skis and surf boats, competitors or teams or crews are deemed to have correctly finished when any part of the craft crosses the finish line.

**Note 1:** To correctly complete a surf ski race, competitors must have (or have regained) their surf ski and paddle and cross the in-water finish line from the seaward side while maintaining contact with the surf ski and paddle (refer surf ski rules).

**Note 2:** A surf boat is deemed to have correctly finished a race when any part of the craft crosses the finish line with a minimum of three competitors in contact with or in control the boat and the boat must be "fully equipped" (refer surf boat rules).

- C. In events where competitors are required to cross a finish line, and fail to do so correctly, competitors may recover and correctly re-cross the finish line to record their placing.
- D. Once a competitor has been judged to have correctly crossed the finish line, he or she is deemed to have completed the race. The competitor may not re-enter the course to correct any previous race errors.

### 3.1 Judging

- A. All events shall be judged visually or by electronic means. Placings shall be decided by finish Judges. Ties (dead heats) shall be declared as such.
- B. Where available, electronic equipment (including video or other technology judging aids) should be utilised in the judging process.
- C. Should electronic means be used to aid the judging and/or recording of races, competitors must place tags as directed by the relevant Official, (e.g., worn in a vest, placed around a specified wrist or ankle, or placed on a designated part of their craft/surf boat etc.). If used for judging the result of such races shall then be determined by the order of the finish of the tags across the finish line. In the event of

failure of the electronic tags, all placings in a race shall be visually judged and/or recorded using normal methods.

- D. Judges shall be positioned to ensure a clear view of the finish line. Where appropriate Judges shall be placed in elevated positions.
- E. Judge One selects finishers one and two; Judge Two selects finishers two and three and so on, (that is, Judge One is primarily responsible for finisher one, as well as noting who finished second).
- F. Should video or other electronic judging aids be used to properly determine the result of a race, the initial judging result shall not be declared as final, and the Chief Referee/Sectional Referee and Chief Judge shall determine the final finish result of the event.
- G. The decisions of the Finish Judges, when finalised, shall be regarded as the final results, and no protest or appeal shall be permitted.
- H. At the Chief Judge's signal, placing decals shall be issued and/or names recorded.
- I. The Chief Referee may allow competitors or team managers to view video playback, or other electronic judging aids under controlled circumstances.

### **3.2 Time limits**

- A. A time limit may be imposed on the duration of an event at the Chief Referee's discretion. Competitors shall be advised of any time limits prior to the commencement of a round of the event.
- B. The Chief Referee may instruct competitors to withdraw from the event prior to finishing when the time limit has been reached or when the number of competitors required for subsequent rounds have qualified by completing the race without disqualification.

## **4. SEEDING**

Seeding shall be used.

### **4.1 Seeding in heats**

For the first round of an event, entries from the same club or nation will be seeded in different heats if possible.

### **4.2 Seeding in semi-finals and finals**

- A. Seeding is required for all rounds after the heats. Seeding for further rounds, quarterfinals, semi-finals, and finals shall be based on the result of heats.
- B. Based on the results of heats, and/or further rounds, or semi-finals, the top 16 competitors or teams shall be assigned places in the final of the following events: Surf Race, Surf Teams Race, Run-Swim-Run, Beach Run, Surf Ski Race, Surf Ski Relay, Board Race, Board Relay, Oceanman/Oceanwoman, Oceanman/ Oceanwoman Relay.
- C. Where required (for point score purposes, etc.) A- and B-finals shall be conducted in the following events: Beach Flags, Rescue Tube Race, Rescue Tube Rescue, Beach Sprint, Beach Relay and Board Rescue. Based on the results of heats or semi-finals, the top eight competitors or teams shall be assigned places in the A-final. The ninth through sixteenth top competitors or teams shall be assigned places in the B-final.
- D. When one or more competitors or teams withdraw from a final of 16 or more competitor/team, up to a maximum of four competitors or teams shall be called forward from the reserves list. Reserves will come from the same qualifying race as the withdrawn competitor or team. The final shall not be re-seeded.
- E. Where one or more competitors or teams are called up to an A-Final of 8 competitors or withdraw from a B-final, alternate competitors up to a maximum of four competitors shall be called forward from the heats. The B-final shall not be reseeded. Should insufficient reserves be on standby the B-final shall progress with those who have marshalled. Reserves will come from the same qualifying race as the withdrawn competitor or team. The B-final shall not be re-seeded.
- F. Ties: When a tie occurs that qualifies for a final, if possible (in terms of the number of competitors), the tied competitors or teams shall advance to the appropriate final. If there are insufficient places available in the final, a repêchage heat shall be conducted between the tied competitors or teams to determine the finalists.

### 4.3 Draws for position

The number of entries received for events will determine the necessity to conduct heats and further rounds prior to conducting a final.

The method used for the draws, including draws for initial heats, and seeding of competitors, shall be approved by the Chief Referee.

To assist with the fair conduct of competition if there is an even number of competitors in a heat, wherever practicable, at least half the competitors who correctly completed the course should qualify for the next round of the event (e.g., if there are 16 starters in a race at least 8 who correctly complete the course should qualify for the next round of the event). If there is an uneven number of competitors in a heat, wherever practicable, at least half the competitors less one who correctly complete the course should qualify for the next round of the event (e.g., if there are 9 starters in a race at least 4 who correctly complete the course should qualify for the next round of the event).

**Note 1:** For Beach Flags refer to the event rules for the draw process.

**Note:** Officials should be mindful of confirmed entries when determining the number of rounds required to conduct an event through to a final and also to, as far as practicable, have an equal number of competitors in each heat.

When vacancies occur due to **withdrawal**, injury, medical reasons or disqualifications in qualifying to further rounds the position shall only be filled by the next placegetter who participated in the same race. Any reserves for an event are only permitted to participate if they report for the event prior to the close of marshalling.

In the events up until a final, should a competitor be disadvantaged due to performing a rescue during that event, and have their chances of qualifying through to the next round disadvantaged, the person may be allowed to proceed through to the next round, providing it can be accommodated. However, should the rescue take place in a final, it will be subject to the Referee's discretion, but generally unless the race is stopped, the race results shall stand.

### 4.4 Beach positions

For swimming, surf ski, board, multi-discipline, and surf boat events, starting positions and lanes shall be consecutively numbered from the left (facing the water) starting with the number 1. For beach events, the number 1 position shall be nearest the water.

### 4.5 Competitor limits

The Chief Referee shall decide whether events shall be conducted in heats, quarter finals, semi-finals, or finals. The recommended maximum number of competitors in a heat or final race shall not exceed the numbers in the following chart. Only the Competition Committee and Chief Referee may authorise changes to these maximum numbers after due consideration is made for effective judging, environmental conditions, safety considerations and fairness for all competitors.

Event	Maximum Number of Competitors/Race
Surf Race	32 competitors
Rescue Tube Race	9 competitors
Run-Swim-Run	32 competitors
Beach Flags	16 competitors (8 in finals)
Beach Sprint	10 competitors (8 in finals)
Beach Run – 2km and 1km	40 competitors
3 x1km Beach Run Relay	40 Teams of 3 competitors
Surf Ski	16 competitors
Board Race	16 competitors
Oceanman/Oceanwoman	16 competitors
Ocean M	16 competitors
Oceanman/Oceanwoman/Ocean M Eliminator	16 competitors
Surf Teams Race	10 teams of 3 competitors

---

<b>Event</b>	<b>Maximum Number of Competitors/Race</b>
Rescue Tube Rescue	9 teams of 4 competitors
Beach Relay	10 teams of 4 competitors (8 in finals)
Surf Ski Relay	16 teams of 3 competitors
Board Relay	16 teams of 3 competitors
Board Rescue	9 teams of 2 competitors
Oceanman/Oceanwoman Relay	16 teams of 4 competitors
Ocean M Lifesaver Relay	24 teams of 4 competitors

## 5. SURF RACE

### 5.1 Event description

With a running start into the water from the start line on the beach, competitors swim around the approximate 400m (280m for Masters) water course designated by buoys, returning to shore to finish between the finish flags on the beach.

To facilitate the recording of placing after the finish, competitors may be positioned either:

- On a straight line drawn at approximately a 30-degree angle from the finishing line and up the beach.
- On a series of lines 10m behind and at right angles to the finishing line and 5m apart.

### 5.2 The course

As shown in the following diagram competitors complete the course as directed. To ensure fair starts and finishes, alignment of the start line and finish line to the buoys may be altered at the discretion of the Chief Referee, depending on the prevailing sea conditions.

The start line – shall be designated by a line in the sand between two poles or a brightly coloured cord stretched between two poles approximately 40m apart. The start line shall be situated approximately 5m from the water's edge and centred on buoy number one (red/yellow).

The finish line – between two green (or area coloured) flags positioned 5m apart – shall be situated approximately 15m from the water's edge, centred on buoy number 9 (green/yellow).

The swimming course shall be marked by buoys (as indicated on the diagram) the furthest situated approximately 170m beyond knee-deep water. Water distances may vary depending upon conditions.

### 5.3 Judging

At the starting signal, the competitors shall commence from the start line, enter the water without impeding any other competitors in the event, swim to and around the buoys, and return to shore and finish between the two green finish flags.

**Note:** Competitors may touch buoys and buoy ropes but are not permitted to use buoy ropes to drag themselves along the course.

Competitors must finish on their feet in an upright position. The finish is judged on the competitor's chest crossing the finish line.

Judges shall be placed to observe the conduct of the event as well as determine competitors' place at the finish line.

### 5.4 Disqualification

In addition to the General Rules in Section 2 and those outlined in S4-1 to 4-3, the following behaviour shall result in disqualification:

- A. Failure to complete the course as defined and described (DQ12).

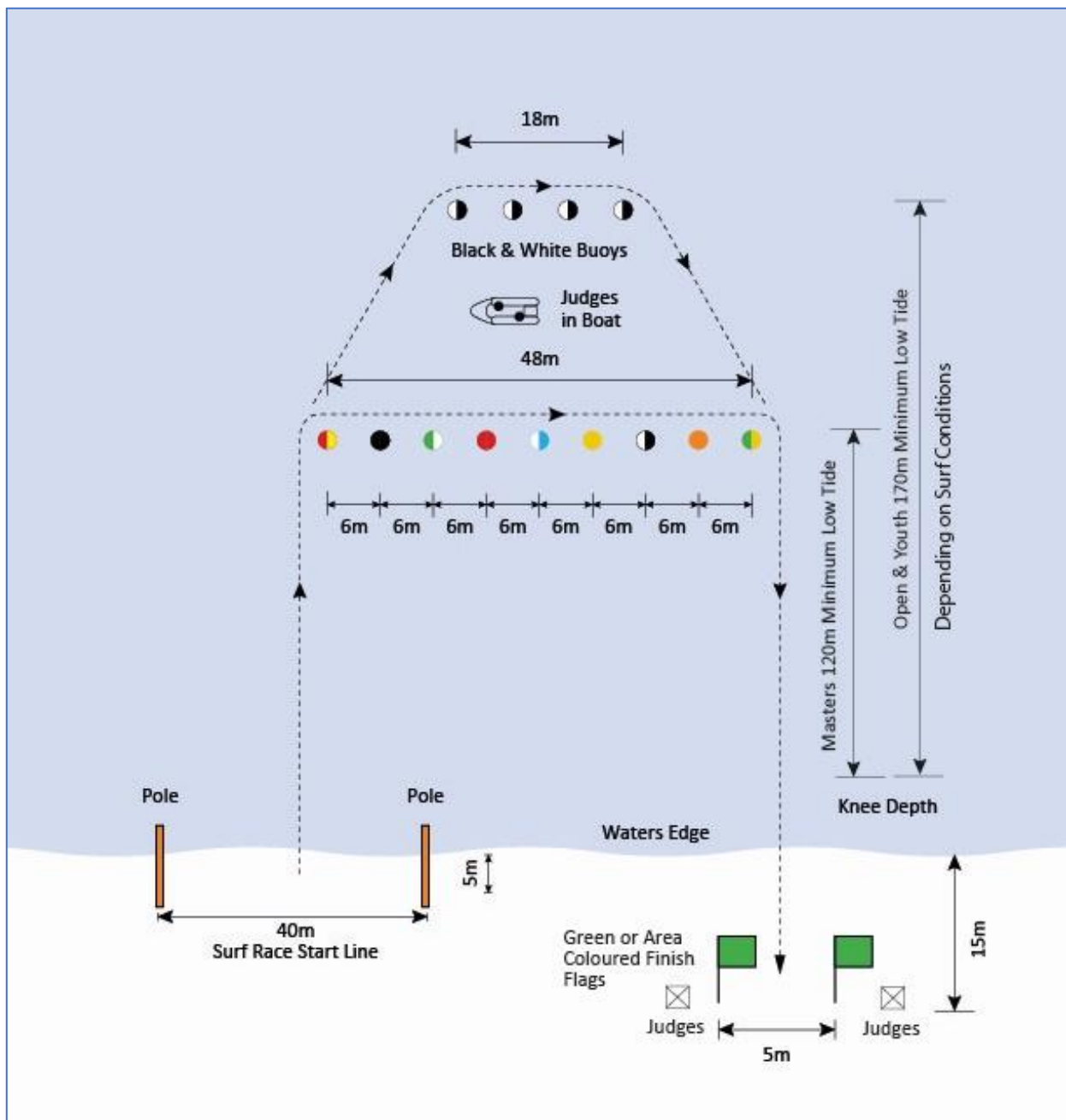

**FIGURE 14: SURF RACE**

(Distances approximate only)

**Note:** The layout of the Competition Arena, including the beach setup relative to the positioning of the buoys, may be adjusted dependent upon the prevailing surf, sweep, and beach conditions.

AGE GROUP	APPROXIMATE DISTANCE
Open and Youth	170m to back set of buoys
Masters	120m to front set of buoys

## 6. SURF TEAMS RACE

### 6.1 Event description

With a running start into the water from the start line on the beach, all three members of each team swim around the approximate 400m (280m for Masters) course designated by buoys, returning to shore to finish between the finish flags on the beach.

**Marshalling:** The three members of each team shall be marshalled behind each other facing the water's edge in their drawn positions. The next team shall be lined up beside the first team and so on.

When all teams are assembled, a direction shall be given to face the competition area. On the direction of an Official the line of competitors nearest the water's edge shall file onto the competition area with the No.1 position to the left facing the water. The first line of competitors is then followed by the second, and third lines. (This procedure spreads competitors from each team over the starting line.)

**Points:** Points are allotted as follows: one for first, two for second, three for third, four for fourth, etc. The team scoring the least number of points will be declared the winner. Should two or more teams be allotted equal points, the team whose full complement of members first completes the course shall be awarded the higher placing.

All competitors who finish shall be recorded as they are placed, and the points will be calculated. If any teams are disqualified, places shall be reallocated, and points then calculated.

If Surf and Surf Teams races are combined, swimmers not in teams shall be eliminated from the points allotment for the purpose of determining the teams race result.

### 6.2 The course

The Surf Teams Race is conducted over the course provided for the Surf Race as shown in the following diagram. To ensure fair starts and finishes, alignment of the start line and finish line to the buoys may be altered at the discretion of the Chief Referee, depending on the prevailing sea conditions.

### 6.3 Judging

At the starting signal, the competitors shall commence from the start line, enter the water without impeding any other competitors in the event, swim to and around the buoys as directed and return to shore and finish between the two green finish flags.

**Note:** Competitors may touch buoys and buoy ropes but are not permitted to use buoy ropes to drag themselves along the course.

Competitors must finish on their feet in an upright position. The finish is judged on the competitor's chest crossing the finish line.

Judges shall be placed to observe the conduct of the event as well as determine competitors' place at the finish line.

### 6.4 Disqualification

In addition to the General Rules in Section 2 and those outlined in S4-1 to 4-3, the following behaviour shall result in disqualification: Failure to complete the course as defined and described (DQ12).

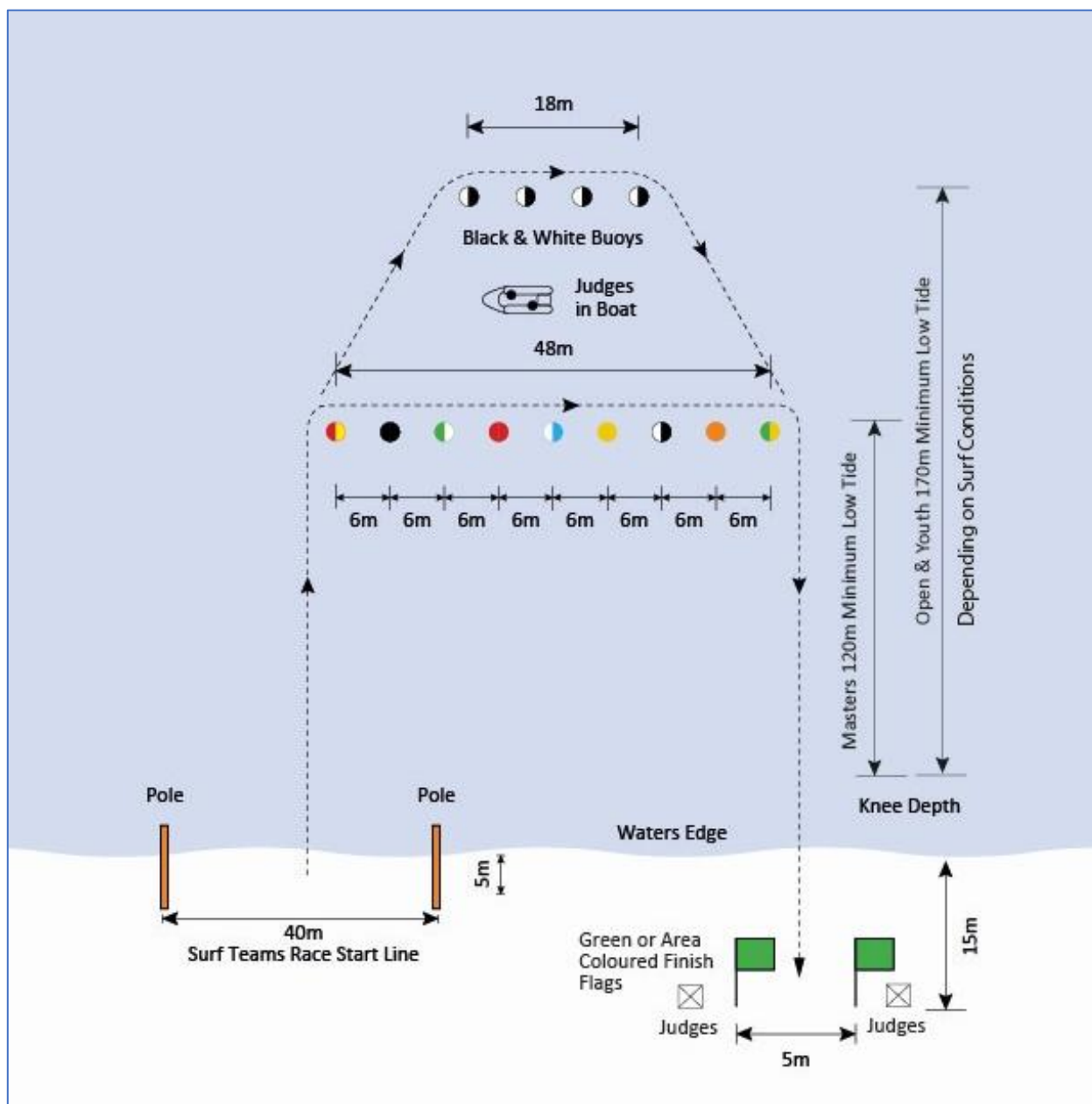

**FIGURE 15: SURF TEAMS RACE**  
 (Distances approximate only)

**Note:** The layout of the Competition Arena, including the beach setup relative to the positioning of the buoys, may be adjusted dependent upon the prevailing surf, sweep, and beach conditions.

AGE GROUP	APPROXIMATE DISTANCE
Open and Youth	170m to back set of buoys
Masters	120m to front set of buoys

## 7. RESCUE TUBE RESCUE

### 7.1 Event description

Four competitors from each team participate in this event: a “victim,” one rescue tube swimmer, and two rescuers. The victim swims approximately 120m to a designated buoy, signals, and waits to be rescued by the rescue tube swimmer. As they return to shore, the remaining two rescuers enter the water to assist. The event finishes when the first competitor in a team crosses the finish line while in contact with the victim.

- A. The start: All four competitors assemble at their team’s allotted position at the start line. Prior to the start signal, the rescue tube swimmer and equipment must be on the shoreward side of the start/finish line. The rescue tube swimmer may hold or don the rescue tube and may hold the swim fins in their hands. Rescue tubes may be worn either with the lanyard/harness over or across one or two shoulders, or over the shoulder and across the chest. Fins may not be worn prior to crossing the start line.
- On the starting signal, the victim enters the water, swims to touch the allotted buoy, signalling arrival by raising the other arm to a vertical position while in contact with the buoy. The victim then waits in the water on the seaward side of the buoy.
  - **Note 1:** The buoy is defined as the buoy only and does not include any attaching ropes and/or straps. Competitors must visibly touch the buoy above the water line before signalling their arrival at the buoy.
  - **Note 2:** Competitors may touch buoys and buoy ropes but are not permitted to use buoy ropes to drag themselves along the course to reach their allotted buoy.
  - The Chief Referee may determine an acceptable alternative method of clearly signalling the victim has touched the buoy.
  - Competitors must start from the correct allotted position. Competitors swimming to and signalling from the wrong buoy shall be disqualified.
- B. Rescue tube swimmer: On the victim’s arrival signal, and from the correct allotted position on the start line, the rescue tube swimmer enters the water, dons the equipment at their discretion, and swims past the left side (viewed from the beach) of the designated buoy to the victim waiting on the seaward side of the buoy. The rescue swimmer secures the rescue tube correctly around the victim’s body and under both arms and clipped to an O-ring. The victim may assist with the securing and clipping of the rescue tube. With the victim clipped into the rescue tube, competitors continue (clockwise) around the buoy towing the victim to the beach.
- Note:** Competitors may touch buoys and buoy ropes but are not permitted to use buoy ropes to drag themselves along the course to reach their allotted buoy.
- C. Rescuers: After the rescue tube swimmer has started to tow the victim to the beach, the two rescuers, at their discretion, may enter the water and assist the rescue tube swimmer to bring the victim to the beach.
- D. The victim must be dragged or carried to the finish.
- E. The finish is judged on the chest of the first team member crossing the finish line on their feet in an upright position while still in contact with the victim (the rescue tube need not be attached).
- Note 1:** It is not required for the rescue tube swimmer to assist rescuers drag or carry the victim to the finish line or for the rescue tube swimmer to cross the finish line.
- Note 2:** While it is not necessary to drag the whole of the victim beyond the finish line teams are requested to immediately move to the shoreward side of the finish line to assist with judging of the event and to enable any trailing teams to finish.

### 7.2 Notes

- A. All team members must start from their allotted positions at the start line.
- B. Rescue tube swimmers and the rescuers, who have previously crossed over the start line (for whatever reason), will not be disqualified provided they return to the shoreward side of the start line prior to beginning their leg of the event.
- C. At the start, rescue tube swimmers may place the rescue tubes and fins on the shoreward side of the start/finish line or may hold their fins and rescue tubes in their hands. The rescue tube lanyard may be donned.
- D. Rescue tubes must be donned correctly, either with the lanyard/harness over or across one or both shoulders, or over one shoulder and across the chest – at the competitor’s discretion.

**Note 1:** Competitors shall be disqualified if the tow line/rope of the rescue tube is intentionally shortened prior to the commencement of a race for the purpose of towing the victim (e.g. looping **and** tying/knotting or clipping the line/rope).

**Note 2:** Competitors shall not be disqualified if the line of the rescue tube becomes wrapped around the victim or is otherwise shortened by a competitor during the conduct of a race.

- E. The victim may assist the rescue tube swimmer in securing the rescue tube. Either may clip-in the rescue tube, but the victim must be clipped into the tube behind the buoy line.
- F. Rescue tube swimmers must tow the victim with the tube secured around the body and under both arms and clipped in an O-ring.
- G. The victim must be towed on their back and the victim cannot be towed in any other way than clipped into the rescue tube.
- H. The victim is permitted to assist by sculling under the surface of the water and kicking, but they must not swim backstroke or any other swim style with an out-of-water recovery.

**Note:** The victim repositioning their arms to a position in front of their head to streamline or for protection is not a disqualification.

- I. At no time, may the victim assist by walking or running, but the victim may assist by lifting the legs during the carry.
- J. Only the rescue tube swimmer may use the swim fins. Rescuers shall not use any equipment or swim fins.

### 7.3 The course

As shown in the following diagram, the course shall be approximately 240m. To ensure fair starts and finishes, alignment of the start line and finish line to the buoys may be altered at the discretion of the Chief Referee, depending on the prevailing sea conditions.

- A. **The start/finish line:** shall be designated by a line in the sand between two poles carrying green (or area coloured) flags or a brightly coloured cord stretched between the two poles, approximately 54m apart and located at the water's edge. Alignment of the start line to the buoys may be altered at the discretion of the Chief Referee, depending on prevailing sea conditions. Any cord placed at the start line may be removed once competitors are in line and prior to the start if there is any concern that the rescue tube may catch on it.
- B. **The swimming buoys** shall be placed as for the Surf Race, so that all competitors have an equal chance with regard to sandbanks and rips, etc.

### 7.4 Equipment

Rescue tube, swim fins: See Section 8.

Unless otherwise advised, competitors must use rescue tubes provided by Organisers.

### 7.5 Judging

Finish Judges shall be positioned at each end of the finishing line at least 5m from the flagpole and in line with each flagpole. An in-boat Course Judge shall be positioned in line with the buoys as shown in the diagram.

Infringements recorded during the event observed by any of the Judges shall be reported to the Chief Referee who shall adjudicate on the infringement with the Judges concerned. An Judge-in- Boat who observes an infringement shall report to the Chief Referee as soon as practical and prior to the race result being declared.

### 7.6 Disqualification

In addition to the General Rules in Section 2 and those outlined in S4-1 to 4-3, the following behaviour shall result in disqualification: Failure to complete the course as defined and described (DQ12).

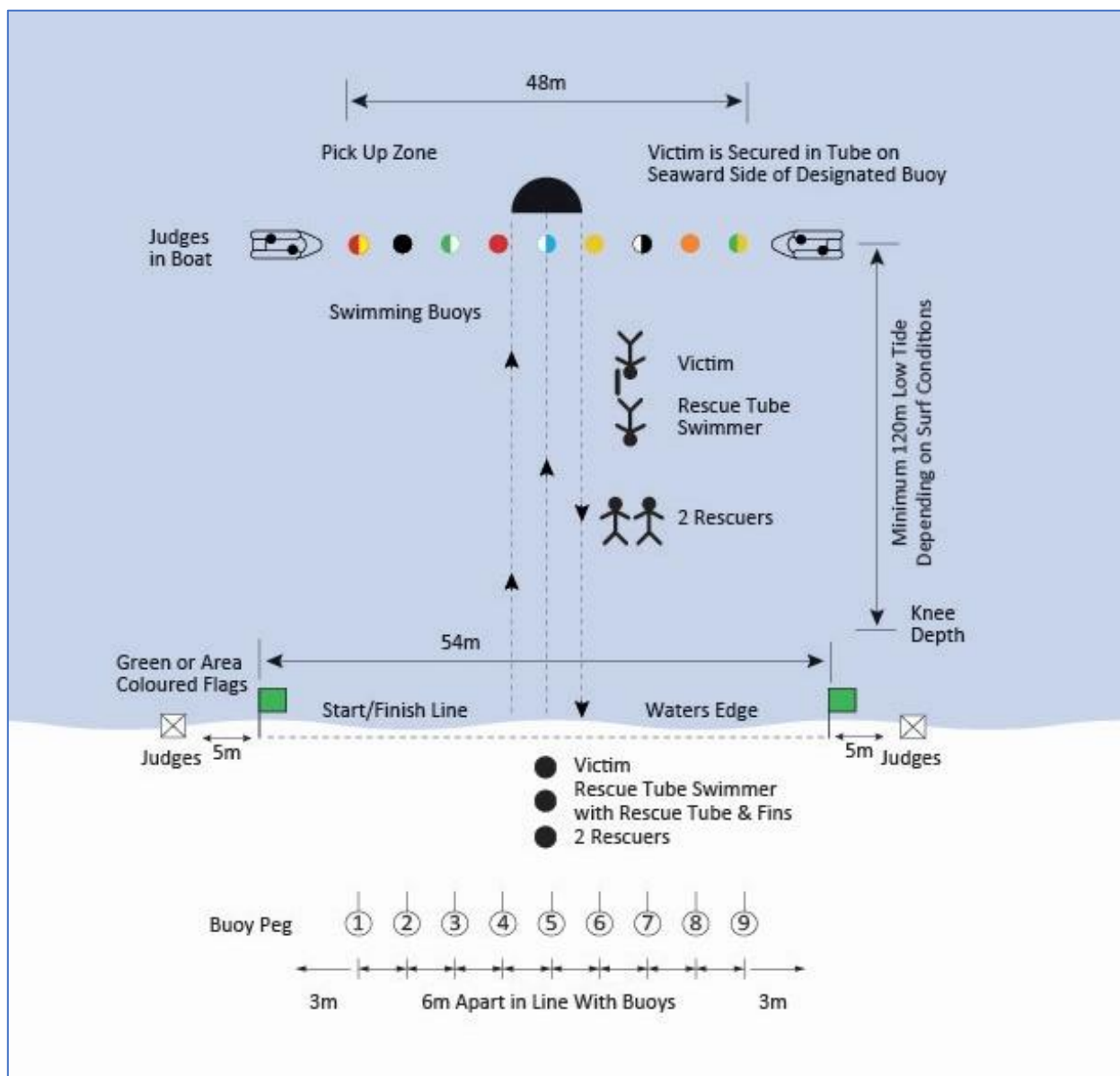

**FIGURE 16: RESCUE TUBE RESCUE**

(Distances approximate only)

**Note:** The layout of the Competition Arena, including the beach setup relative to the positioning of the buoys, may be adjusted dependent upon the prevailing surf, sweep, and beach conditions.

## 8. RESCUE TUBE RACE

### 8.1 Event description

Rescue tubes and fins are placed on the beach, approximately 15m from the water's edge in line with the competitor's designated buoy peg.

Competitors take their positions on the starting line approximately 5m from the water's edge.

On the starting signal, competitors race up the beach to obtain their rescue tubes and fins, and donning the equipment at their discretion, enter the water and swim toward and around (the left side, viewed from the beach) their designated buoy to return to the beach and cross the finish line.

**Note:** Competitors may touch buoys and buoy ropes but are not permitted to use buoy ropes to drag themselves along the course to reach their allotted buoy.

The finish is judged on the chest of the competitor crossing the finish line in an upright position in possession of both fins and with the rescue tube strap over the shoulder.

**Note 1:** At the start, the rescue tube and fins must be positioned at competitors' discretion at and on the seaward side of the competitors' designated buoy peg.

**Note 2:** Rescue tubes may be worn either with the lanyard/harness over one or both shoulders, or over one shoulder and across the chest.

**Note 3:** Competitors shall be disqualified if the tow line/rope of the rescue tube is intentionally shortened (e.g. looping **and** tying/knotting or clipping the line/rope) prior to the commencement of a race.

**Note 4:** Competitors shall not be disqualified if the line of the rescue tube is otherwise shortened by a competitor after the start of a race.

### 8.2 The course

The Rescue Tube Race shall be conducted under the general rules of the Rescue Tube Rescue. The course shall be the same as the Rescue Tube Rescue as shown in the following diagram.

To ensure fair starts and finishes, alignment of the start line and finish line to the buoys may be altered at the discretion of the Chief Referee, depending on the prevailing sea conditions.

### 8.3 Judging

An in-boat Judge shall be positioned in line with the buoys as shown in the diagram. Finish Judges shall be positioned at each end of the finish line at least 5m from the flagpole and in line with each flagpole.

### 8.4 Equipment

**Rescue tube:** See Section 8.

Unless otherwise advised competitors must use rescue tubes supplied by Organisers.

### 8.5 Disqualification

In addition to the General Rules in Section 2 and those outlined in S4-1 to 4-3, the following behaviour shall result in disqualification: Failure to complete the course as defined and described (DQ12).



## 9. RUN - SWIM – RUN

### 9.1 Event description

From the start line, competitors run to pass around the turning flag left hand in and enter the water to swim out to and around the buoys from left to right. Competitors swim back to the beach to again run round the turning flag right hand in before running to the finish line between the two green flags.

**Note:** Officials may direct the course to be conducted with the turning flags and or swimming buoys being rounded in opposite direction

**Note:** Competitors may touch buoys and buoy ropes but are not permitted to use buoy ropes to drag themselves along the course.

### 9.2 The course

As shown in the following diagram, the course shall be laid out so that competitors run approximately 200m, swim approximately 280m, and run approximately 200m to finish between two green (or area coloured) flags.

### 9.3 Judging

Competitors must finish on their feet in an upright position. The finish is judged on the competitor's chest crossing the finish line.

Judges shall be placed to observe the conduct of the event as well as determine competitors' place at the finish line.

### 9.4 Disqualification

In addition to the General Rules in Section 2 and those outlined in S4-1 to 4-3, the following behaviour shall result in disqualification: Failure to complete the course as defined and described (DQ12).



## 10. BEACH FLAGS

### 10.1 Event description

From a prone starting position on the beach in their allotted position, competitors rise, turn and race approximately 20m (15m for Masters) to obtain a baton (beach flag) seated upright in the sand with about two-thirds showing. Since there are always fewer batons than competitors, those who fail to obtain a baton are eliminated. The process is:

- A. Competitors are to lie face down with their toes on the start line with heels or any part of the feet together and visible.
- B. The body's midline should be 90 degrees to the start line and the competitors' hips and stomach (abdomen) must be in contact with the sand.

The elbows and shoulders are to be symmetrical and square to the body and positioned parallel to the start line.

- C. The elbows are to be bent to enable the forearms and hands to also be symmetrical and square to the body and positioned parallel to the start line.

The hands are to be placed on top of each other with the bottom hand flat on the sand, the top hand placed flat on the bottom hand, and with fingertips to wrists.

- D. Competitors are to await the starter's instructions with their heads up.

**Note 1:** Competitors may level, flatten, and compress their starting area prior to the signal to lie on the sand. Competitors are not permitted to create mounds or unreasonably alter the incline of the sand to assist the start.

**Note 2:** Competitors may dig their feet and/or toes into the sand at the start line by digging with their hands or feet before lying on the sand, or with their feet after lying on the sand. However, if toes and/or feet are dug into the sand some part of both feet must be visible to the starter, and they must be together as described.

**Note 3:** Dependent on personal preference the elbows and shoulders do not need to be in complete vertical alignment i.e. the elbows and shoulders may be independently symmetrical provided that they are square to the body, and both positioned parallel to the start line.

**Note 4:** Competitors must comply with the direction of Officials without undue delay. A competitor who causes unreasonable delay to the start of a run-through may be eliminated from the event (DQ8).

### 10.2 Start procedure

Beach Flags start procedure is different from the procedure described in 4.2 "The Start." For Beach Flags, the start is as follows:

Prior to the start, a Marshall shall:

- A. Place competitors in the order as drawn for the run-through.
- B. Accompany competitors to the starting area to ensure they are positioned in proper order.

The Chief/Sectional Referee shall:

- A. Check that all Technical Officials and equipment are in position.
- B. Signal the Official start of each race with a long whistle indicating that the competitors should take their positions on the start line.
- C. Signal the Starter that the competitors are under the Starter's control.
- D. The Starter shall be positioned out of view of the competitors.

### 10.3 The start

On the Starter's "Competitors Ready" command, competitors shall assume the starting position as described. On the Starter's "Heads Down" command, competitors – at once and without delay – shall place their chins on their hands.

- A. After a deliberate pause and when all competitors are stationary, the Starter shall signal the start with a whistle blast.
- B. At the start signal, competitors shall rise to their feet and race to obtain a baton.

### 10.4 Starting infringements

The following behaviours are starting infringements in Beach Flags:

- A. Failure to comply with the Starter's commands within a reasonable time.
- B. Lifting any part of the body from the sand or initiating any starting motion after the Starter's "Heads down" command and prior to the start signal.

If a competitor is disqualified or eliminated, the remaining competitors and batons shall be realigned with no re-draw of positions. The run-through shall continue with the current starting infringement in force until a fair start is affected.

#### **10.5 Draw for positions**

There shall be a preliminary draw for positions and further draws after each round. In semi-finals and finals when contestants have been reduced to eight, there shall be a draw for positions after each run-through.

#### **10.6 Number of competitors eliminated**

In heats, the Chief Referee shall determine whether one or two competitors are to be eliminated in each run-through. In semi-finals and finals, no more than one competitor can be eliminated in any run-through.

#### **10.7 Run-offs**

A run-off between the competitors involved shall be called if two or more competitors hold the same baton, and Judges cannot determine which competitor's hand grasped the baton first – regardless of the hand position on the baton. Likewise, a run-off between the competitors involved shall be called if a baton is "lost" in the sand. If it is apparent that a baton has been "lost" to competitors in the sand, the Chief Judge shall signal (by whistle or verbally) that the baton is "lost," and that the run-through is finished.

#### **10.8 The course**

The Beach Flags course shall be designated by four distinctly coloured 2m high (approximate) poles and "squared" to ensure that all competitors run the same distance to retrieve a baton.

As shown in the following diagram, the course shall be approximately 20m from the start line to the batons, and wide enough to provide for a minimum spacing of 1.5m between each of 16 competitors.

Batons shall be positioned upright in line parallel to the start line, and so that a "perpendicular line" between any two adjacent competitors shall pass approximately through the base of the baton. In other words, batons are aligned on the baton line equidistant between adjacent competitors.

The Beach Flags arena should be free of debris, and if the sand surface is hard, it should be raked to make it safer before and throughout the competition. Similarly in very hot conditions the sand may be watered to reduce the surface temperature.

#### **10.9 Equipment and apparel**

Beach flag (baton): See Section 8.

Trousers or shorts and/or shirts, which comply with team uniform requirements, may be worn at the competitors' discretion.

#### **10.10 Judging**

The Chief Referee/Sectional Referee or their appointee shall be positioned to maintain overall supervision.

The Starter and Check Starters shall be placed at either end of the starting line to observe any starting infringements. Course Judges shall be placed on either side of the course to observe run-throughs and participation infringements.

Finish Judges shall be positioned a few metres behind the line of batons, to reclaim the baton from successful competitors and to set up the batons for the next run-through.

#### **10.11 Elimination and disqualification**

Each run-through or run-off shall be judged as a separate segment of this event. An infringement in one segment shall not be carried over and counted against a competitor in a subsequent segment.

A competitor who commits a starting infringement or who impedes the progress of another competitor shall be eliminated (not disqualified).

A competitor eliminated from the event shall retain the point score and/or placing as at the time in the event. However, a competitor disqualified from the event shall lose all standing from the event.

In Beach Flags events a protest against an elimination must be lodged within two minutes or before the next run through of an event begins (whichever occurs first). If a Beach Flag elimination protest occurs the Chief Referee will immediately consider the protest without delay before proceeding with the event. There will be no Appeal permitted on Beach Flag elimination protest decisions of the Chief Referee.

**Note 1:** A Chief Referee is authorised to refer a Beach Flag elimination protest directly to an on-beach Jury of Appeals representative for decision on the basis of the processes and timings detailed above. No paperwork is required nor is a fee payable if this occurs.

**Note 2:** A competitor is permitted to protest and/or appeal against a disqualification decision in Beach Flag events provided that correct processes are followed as detailed in Section 2 of this Manual.

**Impedance:** Impedance is defined as “the use of hands, arms, feet or legs to impede another competitor’s progress.”

A competitor may otherwise use their body to improve their position in obtaining a baton. A competitor may negotiate the shoulder and or body in front of an opponent, but may not use hands, arms, feet, or legs to obtain or remain in this position.

If a competitor legally obtains this front position and maintains normal running action, the competitor behind is obliged to go around the competitor in front.

A competitor may cross over in front of a slower competitor.

If two or more competitors are guilty of impedance, the competitor who first used hands, arms, feet, or legs may be eliminated.

Notwithstanding the impedance clauses, if it is deemed that the competitor has breached the ILS Code of Conduct and/or competed unfairly (see 2.16 Misconduct), the competitors involved may be disqualified.

In addition to the General Rules in Section 2 and those outlined in S4-1 to 4-3, the following behaviour shall result in disqualification:

- A. Failure to complete the event as described and defined (DQ12).
- B. Failing to comply with the starter’s commands within a reasonable time. (DQ8).  
**Note:** Such competitors shall be eliminated (and not disqualified) from the Beach Flag event.
- C. Picking up or blocking more than one baton– e.g., lying on a baton or covering a baton from sight (DQ11).

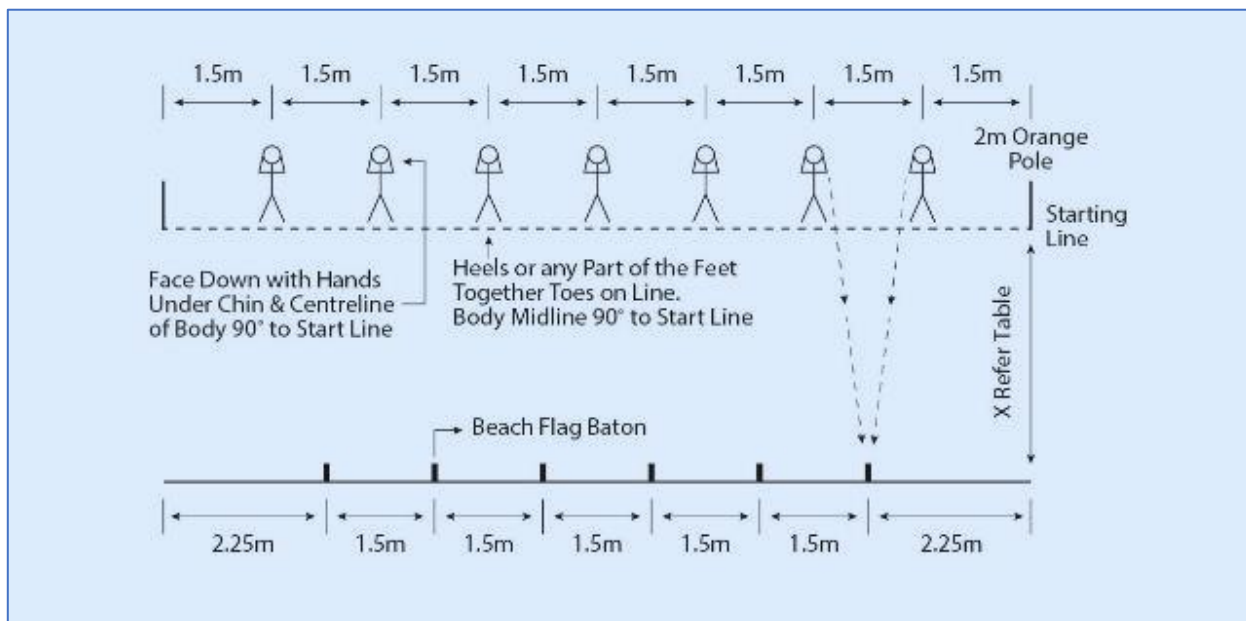

**FIGURE 19: BEACH FLAGS (ONE ELIMINATION PER RUN-THROUGH)**  
 (Distances approximate only)

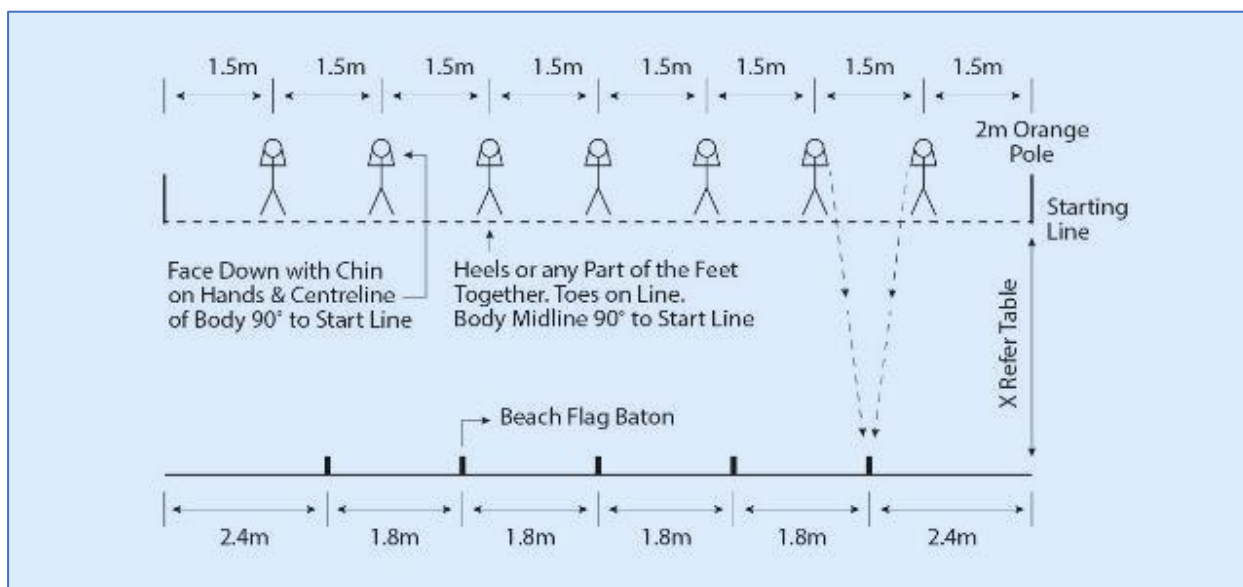

**FIGURE 20: BEACH FLAGS (TWO ELIMINATIONS PER RUN-THROUGH)**  
 (Distances approximate only.)

AGE GROUP	DISTANCE
Open and Youth	20m
Masters	15m

## 11. BEACH SPRINT (90M AND 70M)

### 11.1 Event description

Competitors take their positions in their allotted lanes. At the starting signal, competitors race the 90m (70m for Masters) course to the finish line. The finish is judged on the competitor's chest (only) crossing the finish line. Competitors must finish the event on their feet in an upright position.

### 11.2 The start

No artificial starting blocks are permitted, but competitors may create holes and/or hillocks in and of sand to aid their start. Competitors are not permitted to use any material other than sand to aid the start. Competitors are permitted to flatten or level the sand in their lanes.

### 11.3 The course

As shown in the following diagram, the beach sprint course shall be 90m (70m for Masters) from the start line to the finish line. An area of approximately 20m is to be provided at the start end for marshalling and at the finish end for competitor overrun.

The course shall be rectangular and "squared" to ensure that all competitors run the same distance, and it shall be designated by four distinctly coloured poles, approximately 2m high.

**Running lanes** separated by coloured ropes shall be laid on the beach to assist runners in keeping a straight course. The lanes shall be laid approximately 1.8m in width where possible with a minimum width of 1.5m.

Competitors must remain in their own lane throughout the course.

**Numbered pegs** identifying running lanes shall be placed before the starting mark and beyond the finishing line.

**A marshalling line** shall be made approximately 5m to the rear and parallel to the starting mark and designated by poles approximately 2m high.

### 11.4 Equipment and Apparel

Trousers or shorts and/or shirts, which comply with team uniform requirements, may be worn at the competitors' discretion.

Competitors may be required to wear coloured bibs to assist in judging.

### 11.5 Judging

The Chief Referee/Sectional Referee shall be positioned to maintain overall supervision.

Two Course Judges shall be appointed to ensure the competitors run the course as described.

Finish Judges shall select placings. The competitors shall be placed in the order in which any part of their chest crosses the finish line. Competitors must cross the finish line on their feet in an upright position.

**Note:** A competitor having properly crossed the finish line should stay in their lane and return to the finish line when called to receive their placing from the finish judges.

### 11.6 Disqualification

In addition to the General Rules in Section 2 and General Conditions for ocean competition in S4-1 to 4-3, the following behaviour shall result in disqualification:

Failure to complete the course as defined and described (DQ12).

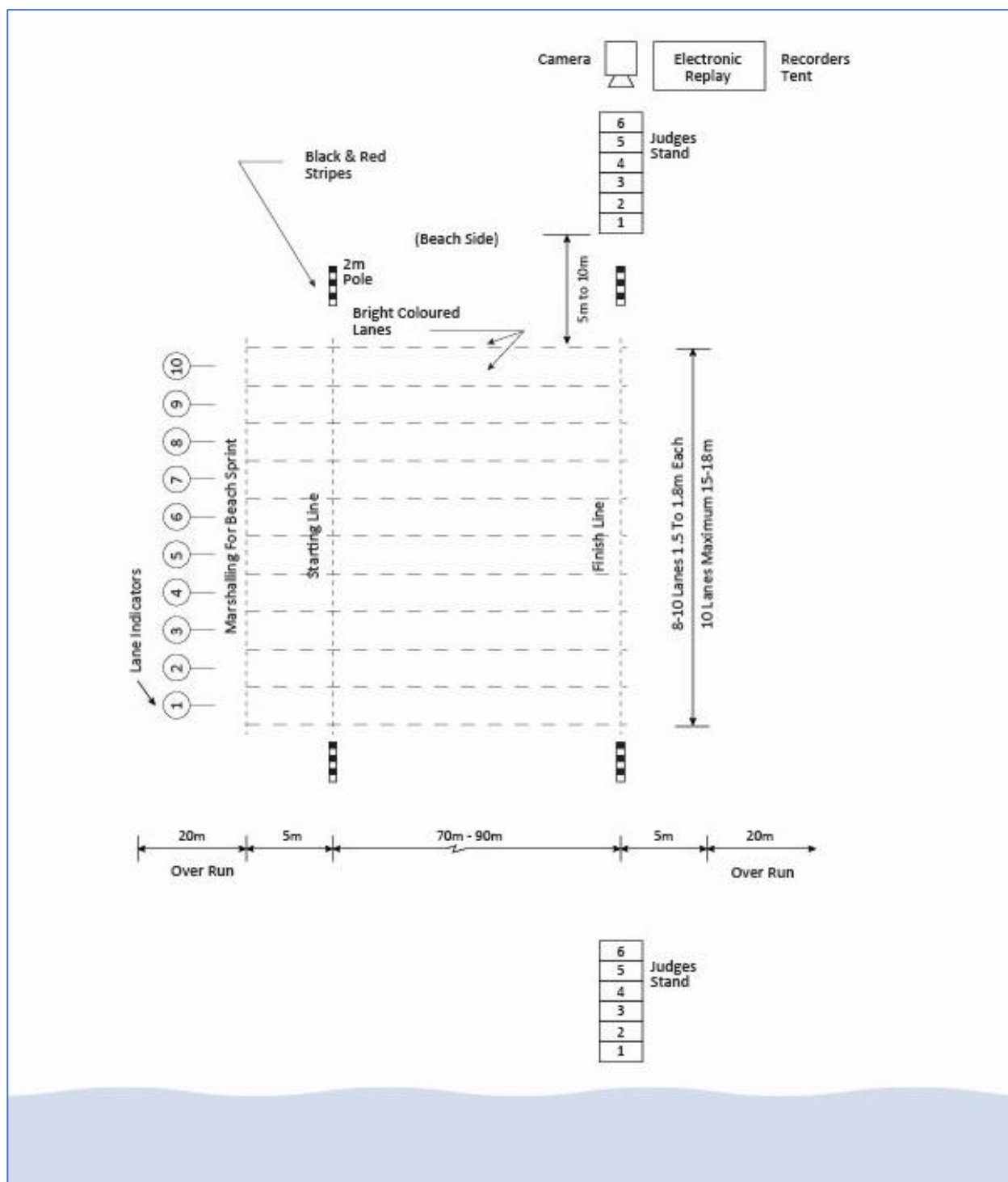

**FIGURE 21: BEACH SPRINT**  
 (Distances approximate only)

AGE GROUP	DISTANCE
Open and Youth	90m
Masters	70m

## **12. BEACH RELAY**

### **12.1 Event description**

Teams of four individuals (three in Masters) compete in baton relay fashion over a 90m (70m for Masters) course. To start, two (one and two members in Masters) competitors take positions in their allotted lane at each end of the course.

After the start each competitor completes a leg of the course with a baton held in either hand and passes the baton at the conclusion of the first, second, and third legs to the next runner. All competitors shall finish their leg of the event on their feet and in an upright position and in contact with their baton.

Competitors are not permitted to interfere with the progress of other competitors.

### **12.2 The start**

The start shall be as for the beach sprint with the first competitor taking the mark.

### **12.3 Baton changeovers**

The baton shall be exchanged in the following manner:

- A. The competitor coming in to exchange the baton must carry the baton to the front line. (The baton may not be thrown to the next competitor.)
- B. Competitors receiving the baton on the first, second, and third exchange can be moving while taking the baton but will be disqualified if any part of the body or hands cross the front line before taking possession of the baton.
- C. If a baton is dropped during the exchange, the receiver may recover the baton (ensuring that there is no interference to other competitors) and continue the race in their allotted lane.
- D. If a baton is dropped at any other stage, the competitor may recover the baton (providing that there is no interference to other competitors) and continue the race in their allotted lane.

### **12.4 The course**

The course shall be similar to the Beach Sprint as shown in the following diagram.

### **12.5 Equipment and apparel**

**Baton:** See Section 8.

Trousers or shorts and/or shirts, which comply with team uniform requirements, may be worn at the competitors' discretion.

Competitors may be required to wear coloured bibs to assist in judging.

### **12.6 Judging/changeovers**

In general, judging shall be as for the beach sprint with the Chief Referee, Course Judge, and the Finish Judges assuming similar duties in regard to the start and finish.

Course Judges shall be appointed to check the changeover lines for infringements at each end during the changeovers.

Any infringements including changeovers observed by the Course Judges shall be reported to the Chief Referee/Sectional Referee.

### **12.7 Disqualification**

In addition to the General Rules in Section 2 and those outlined in S4-1 to 4-3, the following behaviour shall result in disqualification: Failure to complete the course as defined and described (DQ12).

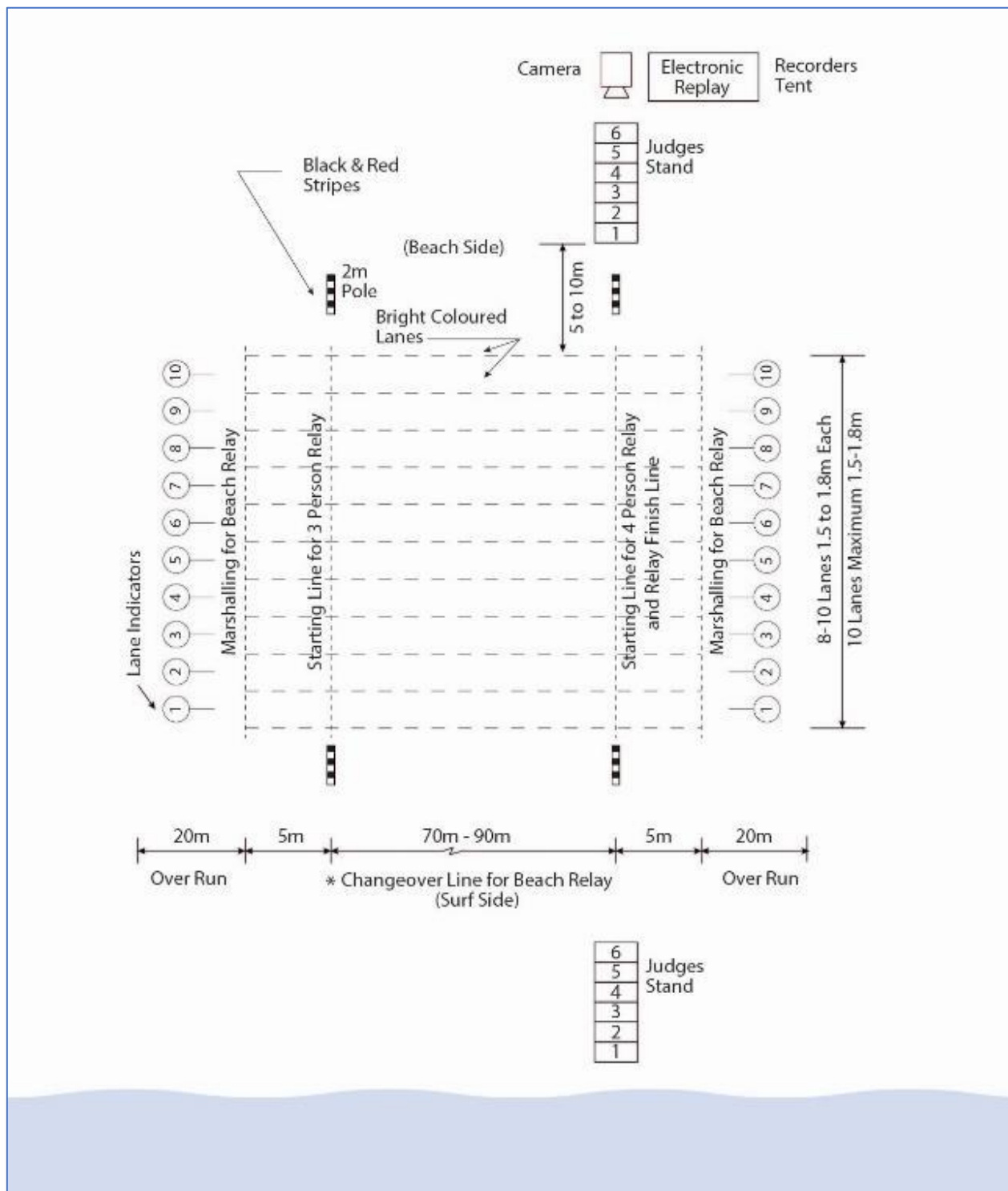

**FIGURE 22: BEACH RELAY**  
 (Distances approximate only)

AGE GROUP	DISTANCE
Open and Youth	90m
Masters	70m

### 13. BEACH RUN (2KM AND 1KM)

#### 13.1 Event description – 2km

Competitors race 2km on the beach. The course design shall maintain the total distance and be set based on the venue's features. The default lap distance is 500m. The Chief Referee may set a 1km lap distance on beaches with more room.

Unless otherwise advised by the Chief Referee, on the starting signal, competitors race along the left side of the lane to round clockwise or right hand in the turning poles 250m distant and return 250m toward the start/turn flags.

Competitors then round all turning flags (clockwise or right hand unless otherwise advised) and proceed back down the beach to round the turning flags as before and repeat four times. On the last lap competitors cross the finish line to complete the race.

Deliberately jostling or obstructing another competitor so as to impede their progress is not permitted.

Judges shall be placed to observe the conduct of the event as well as determine competitors' place at the finish line.

The finish is judged on the competitor's chest crossing the finish line. Competitors must finish on their feet in an upright position.

#### 13.2 Event description – 1km

Competitors race 1km on the beach on the course as described above.

#### 13.3 The course

The course (as shown in the following diagram) shall be laid out on the beach (on soft sand where practical) parallel to the water's edge.

**The start line** shall be designated by a line in the sand, or a brightly coloured synthetic cord stretched between two poles with green and yellow flags attached. The finish line shall be two green flags placed approximately 5m apart and on the shoreward side of the start/turn line. The Chief Referee shall determine the length of the start/turn line.

**Running lanes:** The course shall be divided into two lanes parallel to the waterline. The lane closest to the water shall be for legs running from the start/finish lines. The lanes shall be divided by coloured tape, bunting, or other appropriate material.

**Note:** Should the course be run in the reverse direction the outwards legs shall be on the shoreward side and the return legs on the water side.

Two poles with green and yellow flags attached approximately 5m apart and situated approximately 250m from the start at the end of the lane divider shall designate the turning point.

#### 13.4 Equipment and apparel

Trousers or shorts and/or shirts, which comply with team uniform requirements, may be worn at the competitors' discretion. Footwear is optional.

#### 13.5 Judging

The Chief Referee/Sectional Referee shall be positioned at one side of the course to maintain overall supervision.

Course Judges may be appointed to ensure the competitors run the course without interference to other competitors.

A Judge shall be positioned at the turning poles to ensure no unnecessary jostling or interference occurs.

Finish Judges shall select placings.

#### 13.6 Disqualification

In addition to the General Rules in Section 2 and those outlined in S4-1 to 4-3, the following behaviour shall result in disqualification: Failure to complete the course as defined and described (DQ12).

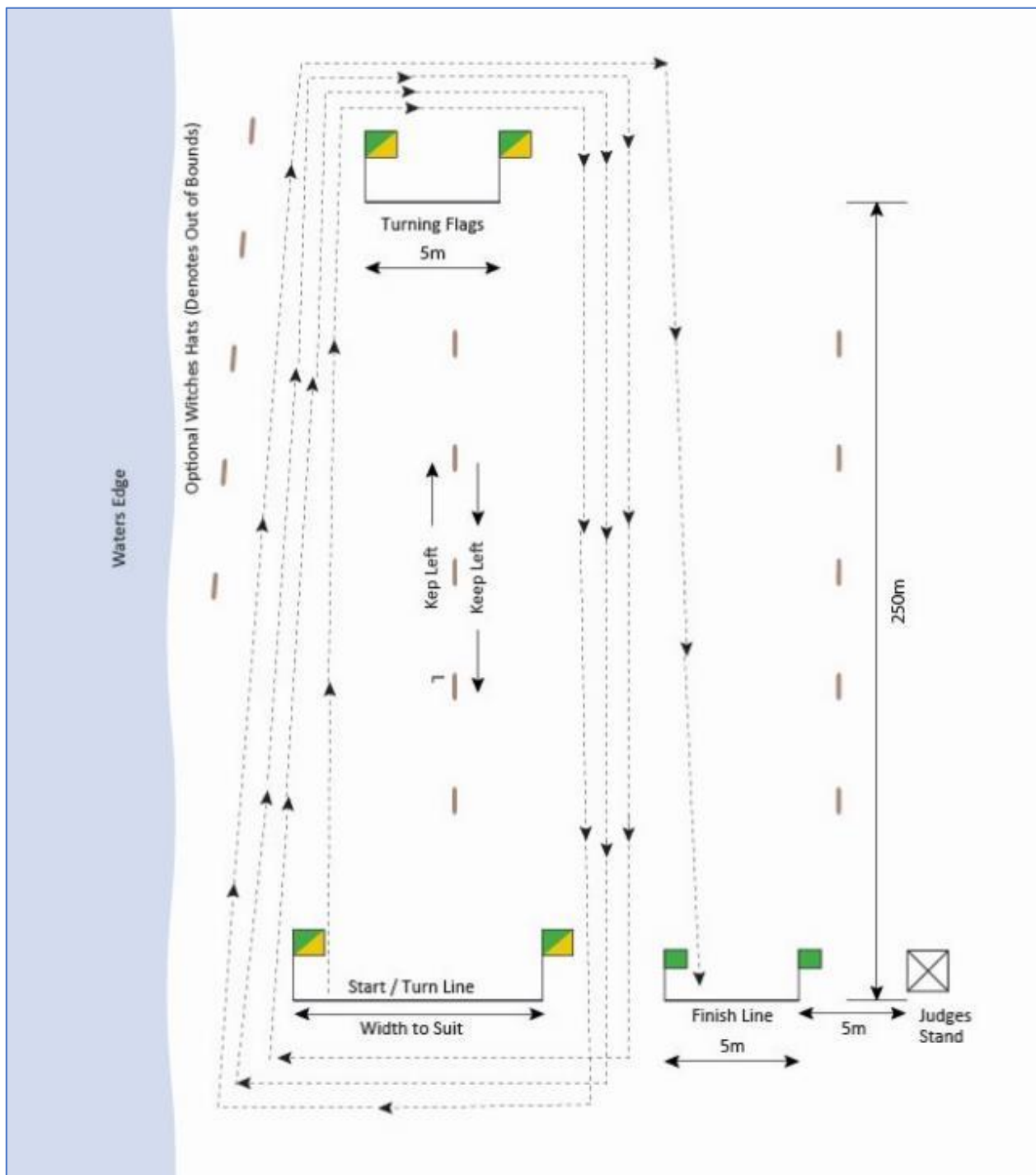

**FIGURE 23: BEACH RUN (1KM AND 2KM)**  
 (Distances approximate only)

DISTANCE	COURSE
1km Beach Run	2 x 500m legs
2km Beach Run	4 x 500m legs

## 14. BEACH RUN RELAY (3 X 1KM)

### 14.1 Event description – 3 x 1km

Three competitors' race 1km each on the beach. The course design shall maintain the total distance and be set based on the venue's features. The default lap distance is 500. Alternatively, for beaches with more room, the Chief Referee may set a 1km lap distance.

On the starting signal, competitor's race along the left side of the lane to round the turning poles (clockwise or right hand in unless otherwise advised) and return to the turning flags and repeats the course. The incoming competitor rounds the first turning flag (clockwise or right hand in unless otherwise advised) and tags with the outgoing competitor who is waiting at a line approximately in the centre of the changeover zone as directed by the relevant Official in the changeover zone between the first and second turning flags. The tag must take place after the first turning flag and before the outgoing competitor rounds the second the turning flags.

The second competitor completes the same course as outlined above.

The third competitor completes the same course as outlined above before crossing the finish line.

Deliberately jostling or obstructing another competitor or team so as to impede their progress is not permitted.

Judges shall be placed to observe the conduct of the event as well as determine competitors' place at the finish line.

The finish is judged on the competitor's chest crossing the finish line. Competitors must finish on their feet in an upright position.

### 14.2 The course

The course (as shown in the following diagram) shall be laid out on the beach (on soft sand where practical) parallel to the water's edge in two lanes.

**The start line** shall be designated by a line in the sand, or a brightly coloured synthetic cord stretched between two poles with green and yellow flags attached. The finish line shall be two green flags placed approximately 5m apart and on the shoreward side of the start/turn line. The Chief Referee shall determine the length of the start/turn line.

**Running lanes:** The course shall be divided into two lanes parallel to the waterline. The lane closest to the water shall be for legs running from the start/finish lines (first leg for both team members). The lanes shall be divided by coloured tape, bunting, or other appropriate material.

**Note:** Should the course be run in the reverse direction the outwards legs shall be on the shoreward side and the return legs on the water side.

Two poles with green and yellow flags attached approximately 5m apart and situated approximately 250m from the start at the end of the lane divider shall designate the turning point.

### 14.3 Equipment and apparel

**Baton:** See Section 8.

Trousers or short pants and/or shirts, which comply with team uniform requirements, may be worn at the competitor's discretion. Footwear is optional.

### 14.4 Judging

The Chief Referee/Sectional Referee shall be positioned at one side of the course to maintain overall supervision.

Course Judges may be appointed to ensure the competitors run the course without interference to other competitors.

A Judge shall be positioned at the turning poles to ensure no unnecessary jostling or interference occurs.

Finish Judges shall select placings.

### 14.5 Disqualification

In addition to the General Rules in Section 2 and those outlined in 4.1 through 4.3, the following behaviour shall result in disqualification: Failure to complete the course as defined and described (DQ12).

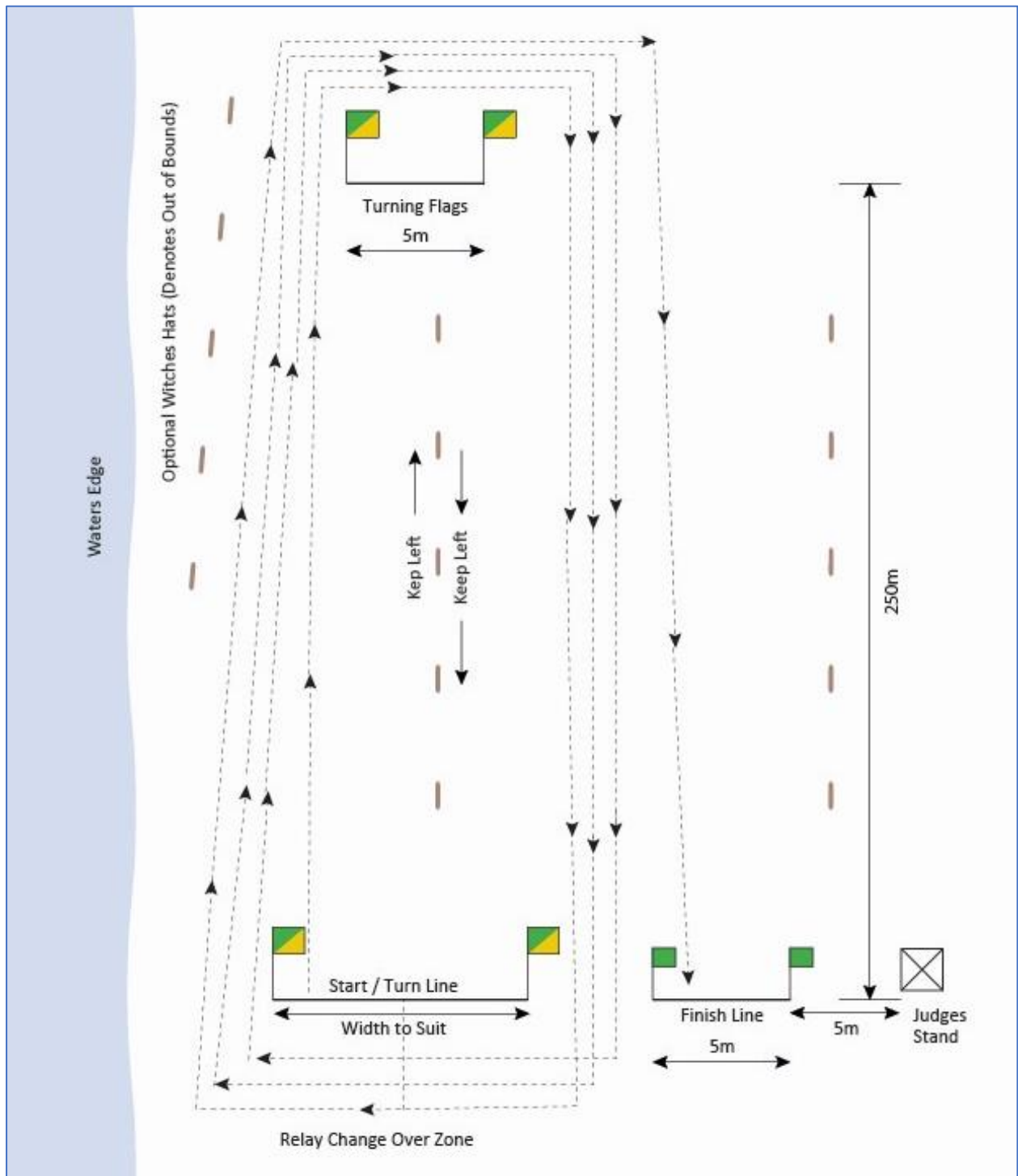

**FIGURE 24: BEACH RUN RELAY**  
 (Distances approximate only)

DISTANCE	COURSE
3x1km Beach Run Relay	3x1km (2x500m legs for each competitor)

## 15. SURF SKI RACE

### 15.1 Event description

A Single Surf Ski is a craft propelled primarily by a competitor with a paddle. Refer to Section 8 for details.

Competitors steady their surf skis in line in approximately knee-deep water about 1.5m apart. Competitors must obey directions from the Starter or Check Starter concerning surf ski alignment at the start.

On the starting signal, competitors paddle their surf skis around the course marked by buoys and return to finish when any part of the surf ski crosses the in-water finish line – ridden, gripped, or carried by the competitor.

Competitors may lose contact with or control of their surf ski without necessarily being disqualified. To complete the race, competitors must have (or have regained) their surf ski and paddle and cross the in-water finish line from the seaward side while maintaining contact with the surf ski and paddle.

Competitors are not permitted to hold or otherwise interfere with other competitors' surf skis or deliberately impede their progress.

### 15.2 The course

The course layout shall be as detailed in the following diagram.

To ensure fair starts and finishes, alignment of the start line and finish line to the buoys may be altered at the discretion of the Chief Referee, depending on the prevailing water conditions.

**Buoys:** Three orange (or area coloured) buoys equal in size to a 50 litre drum shall be used: two “turning buoys” shall be placed approximately 75m apart, and a minimum of 300m (250m for Masters) paddling distance from knee depth water at low tide mark. The third “apex” buoy shall be placed midway and approximately 15m seaward of the turning buoys thus forming an arc with them.

**The start line** need not necessarily be identified, but if required it shall be marked by two poles and positioned so that the centre of the start line is aligned with the first turning buoy.

**The finish line** shall be between two orange (or area coloured) flags mounted on stands or poles or other suitable markers in a position where the craft will finish afloat. The centre of the finish line is aligned with the third turning buoy (allowing for prevailing surf conditions).

**Dry start and finish:** If conditions are such that a fair start and/or finish cannot be provided, a dry start and/or dry finish may be used. See below.

### 15.3 Dry Start and Dry finish

For a dry start, competitors, with their skis and paddles line up in their drawn positions between two start 2m poles approximately 5m from the water's edge and 35m apart.

At the Starters signal the competitors at their own discretion carry their craft to the water and paddle the surf ski course as per the diagram.

The dry finish line shall be situated on the beach approximately 15m from the water's edge. It shall be 20m in length and marked at each end by a flag on a 4m pole. Finish flags shall be the same colour(s) as the course buoys.

- A. Competitors must paddle their surf skis around the last course buoy and shall not be disqualified if they lose contact with or control of their craft or paddle after the last course buoy on the return.
- B. Competitors need not finish with craft or paddle.
- C. The finish is judged on the competitor's chest crossing the finish line. Competitors must finish on their feet in an upright position.
- D. A member of the competitor's team assists with the removal of the competitor's craft and paddle from the course. A registered team coach, manager, or other registered team personnel are permitted to function as a handler. With the Chief Referee's approval, non-team members may also function as handlers.
- E. Handlers shall:
  - Not be required to wear a competition cap.
  - Wear a distinctive high visibility vest.
  - Make every effort to ensure that they and the equipment they are handling do not impede other competitors.
  - Comply with all instructions of the Officials.

#### **15.4 Equipment**

Surf ski and paddle: See Section 8.

Replacement surf skis or paddles for a competitor are permitted and may be brought to the water's edge by other team members providing such replacement does not cause any interference to other competitors in the race and further provided that the competitor shall recommence the race from the original starting area.

#### **15.5 Judging**

Judges shall be placed to observe the conduct of the event and to determine competitors' place at the finish.

#### **15.6 Disqualification**

In addition to the General Rules in Section 2 and those outlined S4-1 to 4-3, the following behaviour shall result in disqualification: Failure to complete the course as defined and described (DQ12).

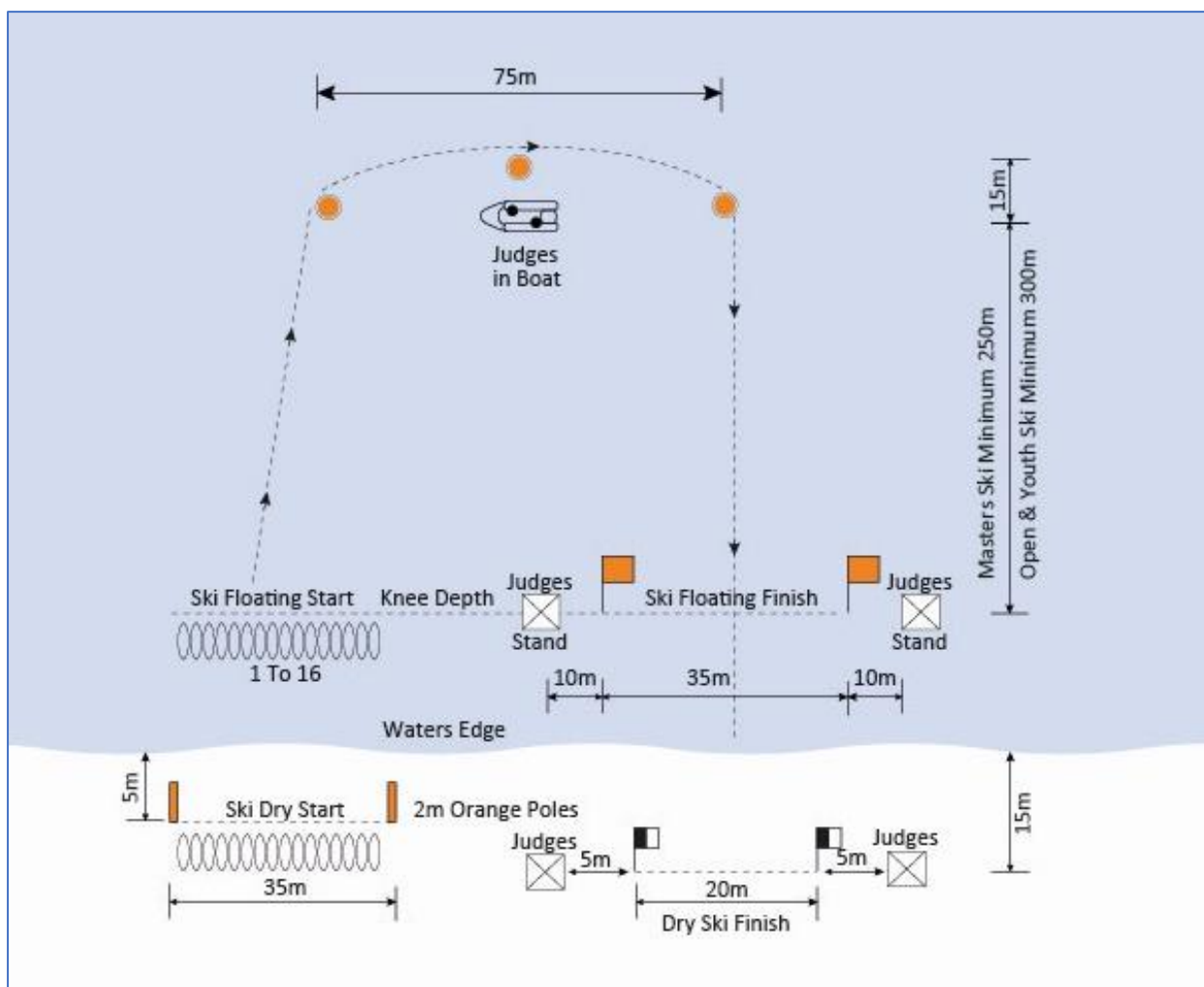

**FIGURE 25: SURF SKI RACE**

(Distances approximate only)

**Note:** The layout of the Competition Arena, including the beach setup relative to the positioning of the buoys, may be adjusted dependent upon the prevailing surf, sweep, and beach conditions.

AGE GROUP	DISTANCE
Open and Youth	300m to base buoys
Masters	250m to base buoys

## 16. SURF SKI RELAY

### 16.1 Event description

The surf ski relay race shall be conducted under the general rules of the surf ski race. Teams shall consist of three competitors, who may use the same craft.

Competitors must obey the Starter's or Check Starter's directions concerning surf ski alignment at the start.

**First competitor:** The first competitor shall be started as in the surf ski race and complete the course marked by the buoys. Competitors may then leave their ski (anywhere after rounding the last turning buoy), return to the shore, run up the beach around the two green and yellow turning flags right hand in and tag with the second competitor at the designated surf ski changeover line.

**The second competitor:** The second competitor completes the same course, rounds the two turning flags, and tags with the third competitor at the designated surf ski changeover line.

**The third competitor:** The third competitor completes the same course, rounds the first turning flag and passes the second turning flag on the shoreward side, to finish between the two green (or area coloured) finish flags.

The first and third competitor in each team commence from the team's drawn starting position. However, the drawn starting position is reversed for the second competitor in each team. For example, in a 16-competitor race in which a team has drawn position 1: the first competitor commences from position 1; the second competitor commences from position 16; the third competitor commences from position 1.

1 <sup>st</sup> & 3 <sup>rd</sup> competitor's starting position	1	2	3	4	5	6	7	8	...	16
2 <sup>nd</sup> competitor's starting position	16	15	14	13	12	11	10	9	...	1

Competitors are not permitted to hold or otherwise interfere with other competitors' surf skis or deliberately impede their progress.

### 16.2 The course

The course layout shall be as detailed in the following diagram. The finish is between two green (or area coloured) flags.

In the surf ski relay, the start/changeover line is located in the water. To ensure fair starts and finishes, alignment of the start line and finish line to the buoys may be altered at the discretion of the Chief Referee, depending on the prevailing water conditions.

### 16.3 Equipment and apparel

Surf ski and paddle: See Section 8.

- A. Members of the team or other members authorised by the Chief Referee shall ensure that any craft used by any of the other team members does not cause any interference to another team or competitor in the race. The craft shall be removed as soon as possible from the water's edge to avoid congestion and possible damage.
- B. If a club enters more than one team in an event, each team shall be required to wear distinguishing numbers or letters marked on their arm, leg, or caps.

### 16.4 Judging

Judges shall be placed to observe the conduct of the event and determine competitors' place at the finish.

Competitors must cross the finish line on their feet in an upright position. The finish is judged on the competitor's chest crossing the finish line.

### 16.5 Control of craft

Competitors may lose control of or contact with the surf ski or paddle on the way out, provided they regain the surf ski (and paddle) and round the last course buoy in contact with the craft and complete the course.

Competitors must paddle their surf skis around the last course buoy and shall not be disqualified if they lose control of or contact with their craft (or paddle) after the last course buoy on the return.

---

### 16.6 Masters Ski Relay Course and Procedure Variation

- A. The Ski course buoys for the Masters Ski Relay shall be as per the Oceanman/Oceanwoman Relay Ski leg. Competitors must round all buoys in the water including the swimming buoys, the black and white board buoys and the three orange ski buoys unless otherwise advised.
- B. The two green/yellow turning flags are placed approximately 15m apart and either on the shoreline or at knee depth water (as appropriate and taking into account prevailing surf conditions so as to minimise the run distance).
- C. The two green (or area coloured) finish flags are placed on the water's edge approximately 5m apart and approximately 5m from the second turning flag.

**Note:** All other conditions shall remain unaltered from the standard course.

### 16.7 Disqualifications

In addition to the General Rules in Section 2 and those outlined in S4-1 to 4-3, the following behaviour shall result in disqualification: Failure to complete the course as defined and described (DQ12).



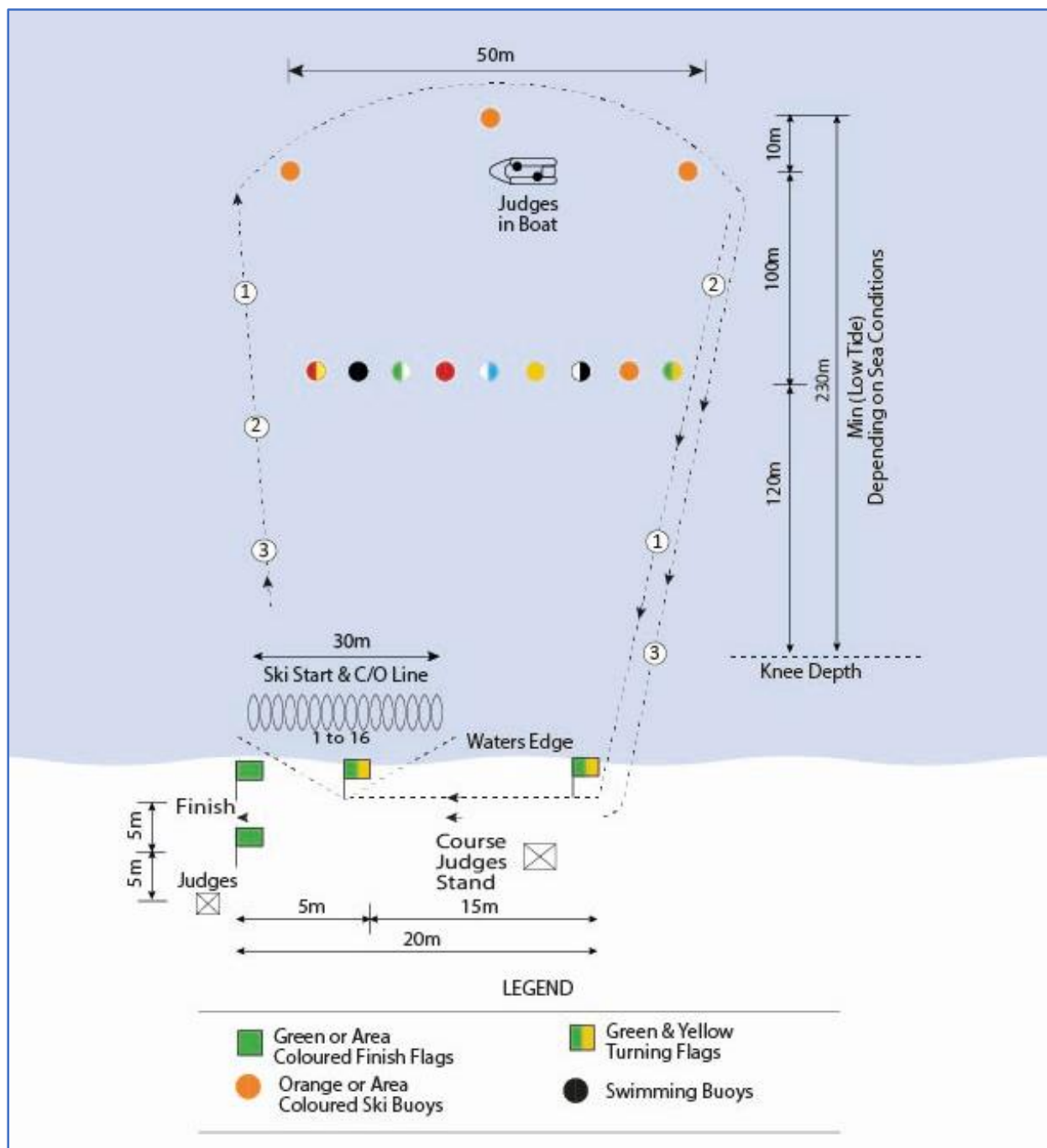

**FIGURE 27: MASTERS SURF SKI RELAY**

(Distances approximate only)

**Note 1:** The layout of the Competition Arena, including the beach setup relative to the positioning of the buoys, may be adjusted dependent upon the prevailing surf, sweep, and beach conditions.

**Note 2:** The turning flags are to be set by the Chief Referee or their designate considering water conditions at the time of a race e.g., the turning flags should be set back up to about 5m from the water's edge in the event of a steep drop off into the water and/or a heavy shore dump for safety, fairness, and practicality. However, on a flat beach and/or little wave surge, the turning flags may be placed at the water's edge or in the water to minimise the run distance. The changeover line may be placed on the beach or in the water depending on conditions and the placement of the turning flags.

## 17. BOARD RACE

### 17.1 Event description

A surfboard is a craft propelled primarily by a competitor's hands and arms. Refer to S8 for details.

Competitors stand on or behind the start line on the beach with their boards 1.5m apart.

At the start signal, competitors enter the water, launch their boards, and paddle the course marked by buoys, return to the beach, and run to cross the finish line.

Competitors are not permitted to hold or otherwise interfere with other competitors' boards or deliberately impede their progress.

### 17.2 The course

The course layout shall be as detailed in the following Board Race diagram.

To ensure fair starts and finishes, alignment of the start line and finish line to the buoys may be altered at the discretion of the Chief Referee, depending on the prevailing sea conditions.

**Buoys:** Three black and white (or area coloured) buoys and equal in size to a 50-litre drum shall be used: two "turning buoys" shall be placed approximately 75m apart, and a minimum 250m distance (same for Masters) from knee-depth water at low tide mark. The third "apex" buoy shall be placed midway and approximately 15m seaward from the turning buoys thus forming an arc with them.

**The start line**, is depicted by a line in the sand between two poles or a bright coloured cord between the two poles, situated on the beach approximately 5m from the water's edge. The start line shall be 30m in length. The middle of the start line should be aligned with the first turning buoy but may be altered at the discretion of the Chief Referee depending on the prevailing conditions to allow all competitors a fair passage around the first buoy.

**The finish line** shall be between two black and white (or area coloured) flags situated on the beach approximately 15m from the water's edge. It shall be 20m in length and marked at each end by a flag on a 4m pole.

The middle of the finish line should be aligned with the third turning buoy, but this may be altered by the Chief Referee depending on the prevailing sea conditions.

**Note:** If an alternate finish is prescribed where competitors run to a line without their board, the finish is judged on the competitor's chest crossing the finish line. Competitors must finish on their feet in an upright position. A member of the competitor's team assists with the removal of the competitor's craft and paddle from the course. A registered team coach, manager, or other registered team personnel are permitted to function as a handler. With the Chief Referee's approval, non-team members may also function as handlers.

Handlers shall:

- Not be required to wear a competition cap.
- Wear a distinctive high visibility vest.
- Make every effort to ensure that they and the equipment they are handling do not impede other competitors.
- Comply with all instructions of the Officials.

### 17.3 Equipment

**Board:** See Section 8.

The use of a replacement board is permitted provided that the competitor recommences the race from the start line. Replacement boards may be brought to the start line by fellow team members providing they do not cause any interference to other competitors.

### 17.4 Judging

The finish is judged on the competitor's chest crossing the finish line. Competitors must finish on their feet in an upright position while in control of the board.

### 17.5 Control of Craft

Competitors may lose contact with or control of their board without necessarily being disqualified. To complete the race, competitors must have (or have regained) their board and cross the finish line from the seaward side while maintaining contact with their craft.

## **17.6 Disqualification**

In addition to the General Rules in Section 2 and those outlined in S4-1 to 4-3, the following behaviour shall result in disqualification: Failure to complete the course as defined and described (DQ12).

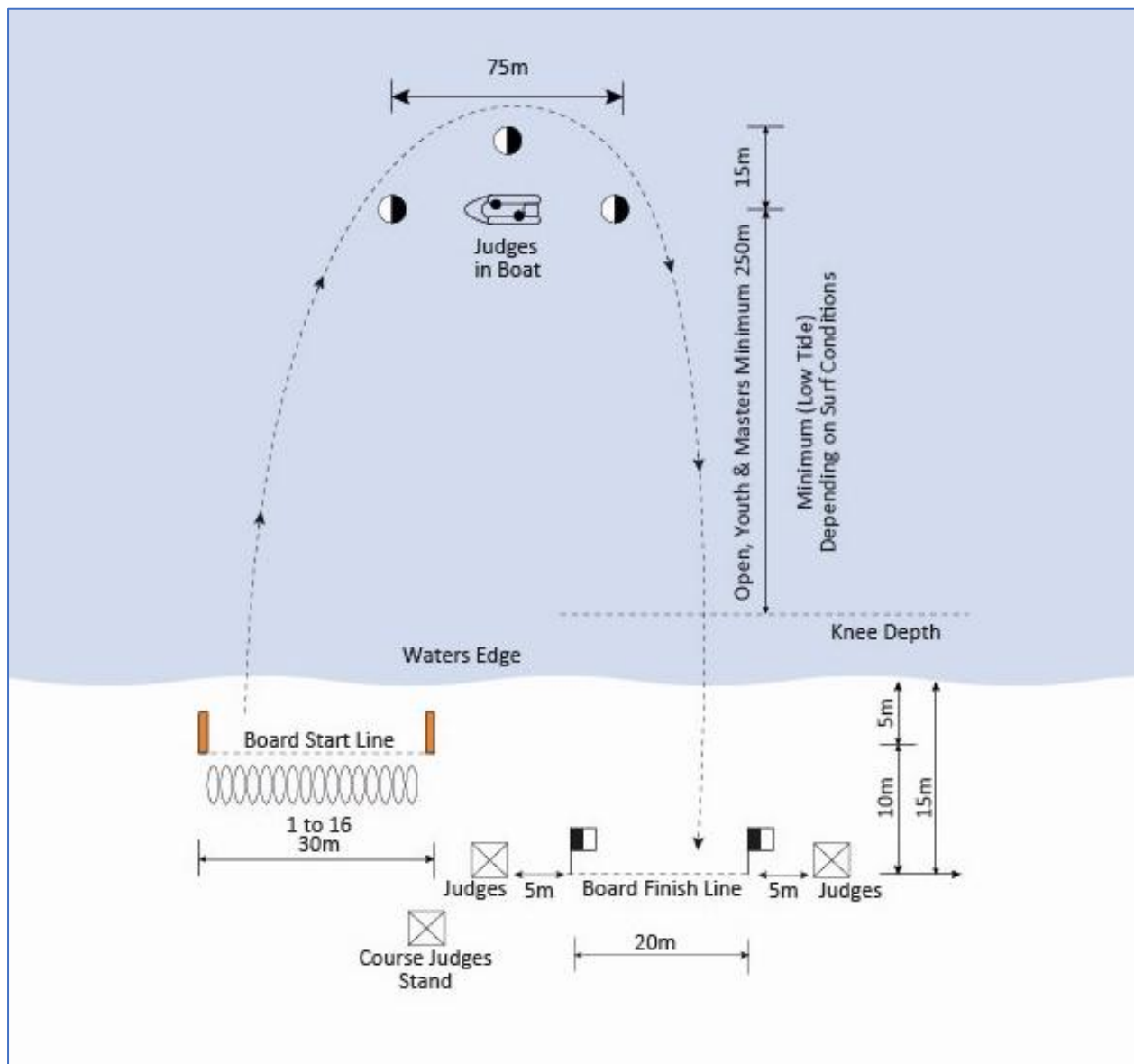

**FIGURE 28: BOARD RACE**

(Distances approximate only)

**Note:** The layout of the Competition Arena, including the beach setup relative to the positioning of the buoys, may be adjusted dependent upon the prevailing surf, sweep, and beach conditions.

AGE GROUP	DISTANCE
Open and Youth	250m to base buoys
Masters	250m to base buoys

## 18. BOARD RELAY

### 18.1 Event description

The Board Relay event shall be conducted under the general rules of the Board Race event. Teams shall consist of three competitors, who may use the same craft.

**First competitor:** The first competitor shall be started as in the Board Race and complete the course marked by the buoys. Competitors may then leave their board (anywhere after rounding the last turning buoy), return to the shore, run up the beach around the two green and yellow turning flags right hand in and tag with the second competitor at the designated board changeover line.

**The second competitor:** The second competitor completes the same course, rounds the two turning flags, and tags with the third competitor at the designated board changeover line.

**The third competitor:** The third competitor completes the same course, rounds the first turning flag and passes the second turning flag on the shoreward side, to finish between the two green (or area coloured) finish flags.

The second and third competitors in the board relay event shall be positioned with their feet on, or shoreward of, the changeover line. The second and third competitors do not need to cross the board start line to enter the water after being tagged.

Competitors in the board relay events must commence their leg of the event from the correct allotted position.

The first and third competitor in each team commence from the team's drawn starting position. However, the drawn starting position is reversed for the second competitor in each team. For example, in a 16-team race in which a team has drawn position 1: the first competitor commences from position 1; the second competitor commences from position 16; the third competitor commences from position 1.

1 <sup>st</sup> & 3 <sup>rd</sup> competitor's starting position	1	2	3	4	5	6	7	8	...	16
2 <sup>nd</sup> competitor's starting position	16	15	14	13	12	11	10	9	...	1

Competitors are not permitted hold or otherwise interfere with other competitors' boards or deliberately impede their progress.

### 18.2 The course

The course layout shall be as detailed for the Board Relay Race and shown in the following diagram.

To ensure fair starts and finishes, alignment of the start line and finish line to the buoys may be altered at the discretion of the Chief Referee, depending on the prevailing sea conditions.

### 18.3 Equipment

**Board:** See Section 8.

- A. The use of a replacement board is permitted provided that the competitor recommences the race from the start line. Replacement boards may be brought to the start line by fellow team members providing they do not cause any interference to other competitors.
- B. Members of the team or other members authorised by the Chief Referee shall ensure that any craft used by any of the other team members does not cause any interference to another team or competitor in the race. Boards shall be removed as soon as possible from the water's edge to avoid congestion and possible damage.
- C. If a club enters more than one team in an event, each team shall be required to wear distinguishing numbers or letters marked on their arm, leg, or caps.

### 18.4 Judging

The finish is judged on the competitor's chest crossing the finish line. Competitors must finish on their feet in an upright position.

### 18.5 Control of craft

Competitors may lose contact with or control of the board on the way out, provided they regain the board and round the last course buoy in contact with the board and complete the course.

Competitors must paddle their board around the last course buoy and shall not be disqualified if they lose contact with or control of their board after the last course buoy on the return leg.

### 18.6 Masters Board Relay Course and Procedure Variation

- A. The Board course buoys for the Masters Board Relay shall be as per the Oceanman/ Oceanwoman Relay Board leg. Competitors must round all swimming buoys and the black and white board buoys unless otherwise advised.
- B. The two green/yellow turning flags are placed approximately 15m apart and either on the shoreline or at knee depth water (as appropriate and taking into account prevailing surf conditions so as to minimise the run distance).
- C. The two green (or area coloured) finish flags are placed on the water's edge approximately 5metres apart and approximately 5m from the second turning flag.

**Note:** All other conditions shall remain unaltered from the standard course.

### 18.7 Disqualification

In addition to the General Rules in Section 2 and those outlined in S4-1 to 4-3, the following behaviour shall result in disqualification: Failure to complete the course as defined and described (DQ12).

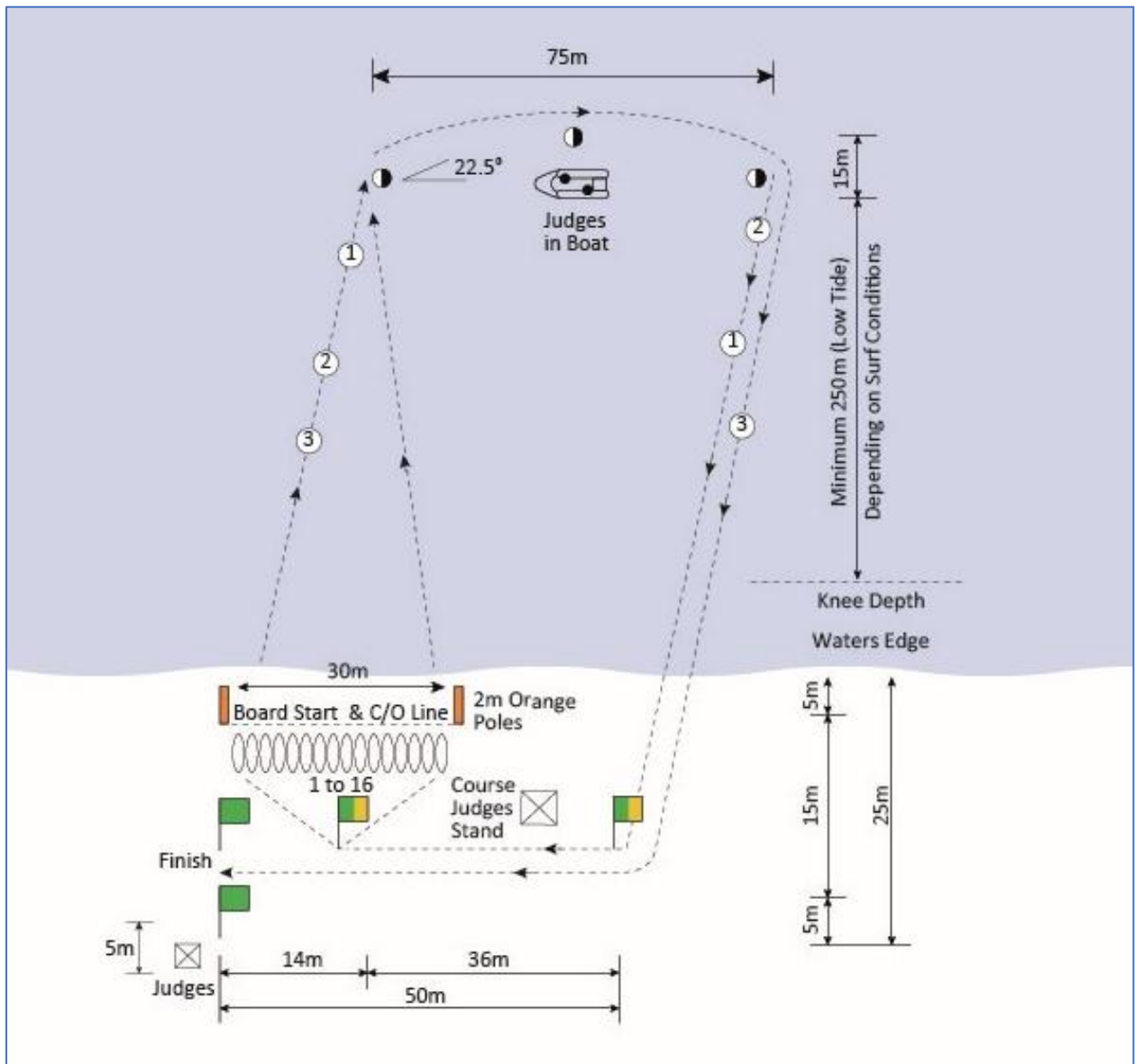
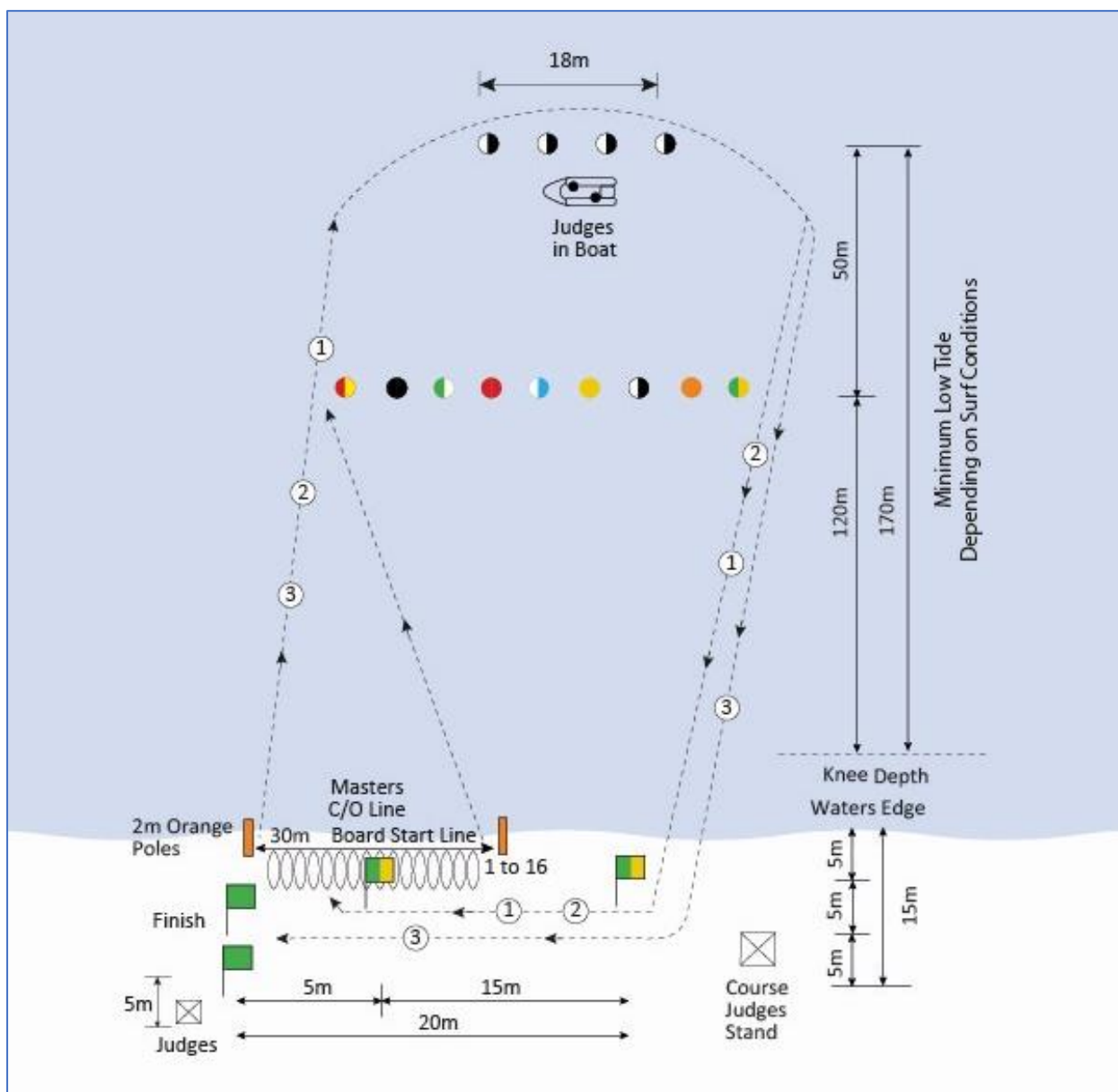

**FIGURE 29: OPEN AND YOUTH BOARD RELAY RACE**

(Distances approximate only)

**Note:** The layout of the Competition Arena, including the beach setup relative to the positioning of the buoys, may be adjusted dependent upon the prevailing surf, sweep, and beach conditions.

AGE GROUP	DISTANCE
Open and Youth	250m to base buoys



**FIGURE 30: MASTERS BOARD RELAY RACE**

(Distances approximate only)

**Note 1:** The layout of the Competition Arena, including the beach setup relative to the positioning of the buoys, may be adjusted dependent upon the prevailing surf, sweep, and beach conditions.

**Note 2:** Masters competitors must round all swim and board buoys to complete the course.

**Note 3:** The turning flags are to be set by the Chief Referee or their designate considering water conditions at the time of a race e.g., the turning flags should be set back up to about 5m from the water's edge in the event of a steep drop off into the water and/or a heavy shore dump for safety, fairness, and practicality. However, on a flat beach and/or little wave surge, the turning flags may be placed at the water's edge or in the water to minimise the run distance. The changeover line may be placed on the beach or in the water depending on conditions and the placement of the turning flags.

## 19. BOARD RESCUE

### 19.1 Event description

In this event, one member of the team swims approximately 120m to a designated buoy, signals, and waits to be picked up by the second member of the team on a board. They both paddle to shore and cross the finish line on the beach in contact with the board.

- A. Both competitors must start from the correct allotted position i.e., the start/finish in line with the competitor's designated buoy peg. Competitors swimming to and signalling from the wrong buoy shall be disqualified.
- B. **First competitor:** From the allotted position on the start line on the beach, and on the start signal, the victim enters the water, swims to touch the allotted swimming buoy, signalling arrival by raising the other arm to a vertical position while in contact with the buoy. The victim then waits in the water on the seaward side of the buoy.

**Note1:** The buoy is defined as the buoy only and does not include any attaching ropes and/or straps. Competitors must visibly touch the buoy above the water line before signalling their arrival at the buoy.

**Note 2:** Competitors may touch buoys and buoy ropes but are not permitted to use buoy ropes to drag themselves along the course to reach their allotted buoy.

- C. The Chief Referee may determine an acceptable alternative method of clearly signalling the victim has touched the buoy.
- D. **Second competitor:** On the victim's arrival signal, and from the allotted position, the board rescuer crosses the start line, enters the water and paddles to the victim on the seaward side of the allotted buoy. The victim must make contact with the board on the seaward side of the buoy. The board must round the buoy clockwise (right hand in) before proceeding to shore with the victim. The board may extend into the shoreward side of the buoy during victim pick-up.
- E. The victim may place themselves on the front or rear of the board. The victim may assist by paddling the board on the return to shore.
- F. The finish is judged on the chest of the first competitor of each team to cross the finish line marked by green (or area coloured) flags on their feet in an upright position, with both rescuer and victim in contact with the board.  
**Note:** While both competitors need to be in contact with the board at the time the first competitor crosses the finish line to record a finish result, it is not necessary for the second competitor to cross the finish line on their feet and/or in contact with the board. However, all teams are requested to immediately move to the shoreward side of the finish line to assist with judging of the event and to enable any trailing teams to finish.
- G. The board rescuer may not start before the victim signals arrival. The board rescuer may cross the start/finish line for any reason and will not be disqualified provided he or she then resumes the correct start position to await the victim's arrival signal.
- H. Competitors are not permitted to hold or otherwise interfere with other competitors' boards or deliberately impede their progress.

### 19.2 The course

The course layout shall be as detailed in the following diagram.

The boards must be paddled around the allotted buoys clockwise (right side in) unless otherwise advised by the Chief Referee prior to the event.

### 19.3 Equipment

**Board:** See Section 8.

### 19.4 Judging

Judges shall be placed to observe the conduct of the event and to determine competitors' place at the finish.

### 19.5 Control of victim or board

Rescuers and victims may lose contact with the board on the return journey, but both must be in contact with the board when crossing the finish line.

### **19.6 Victim pick-up**

While it is not required that the entire board be on the seaward side of the allotted buoy, the victim must make contact with the board on the seaward side.

### **19.7 Disqualification**

In addition to the General Rules in Section 2 and those outlined in S4-1 to 4-3, the following behaviour shall result in disqualification: Failure to complete the course as defined and described (DQ12).

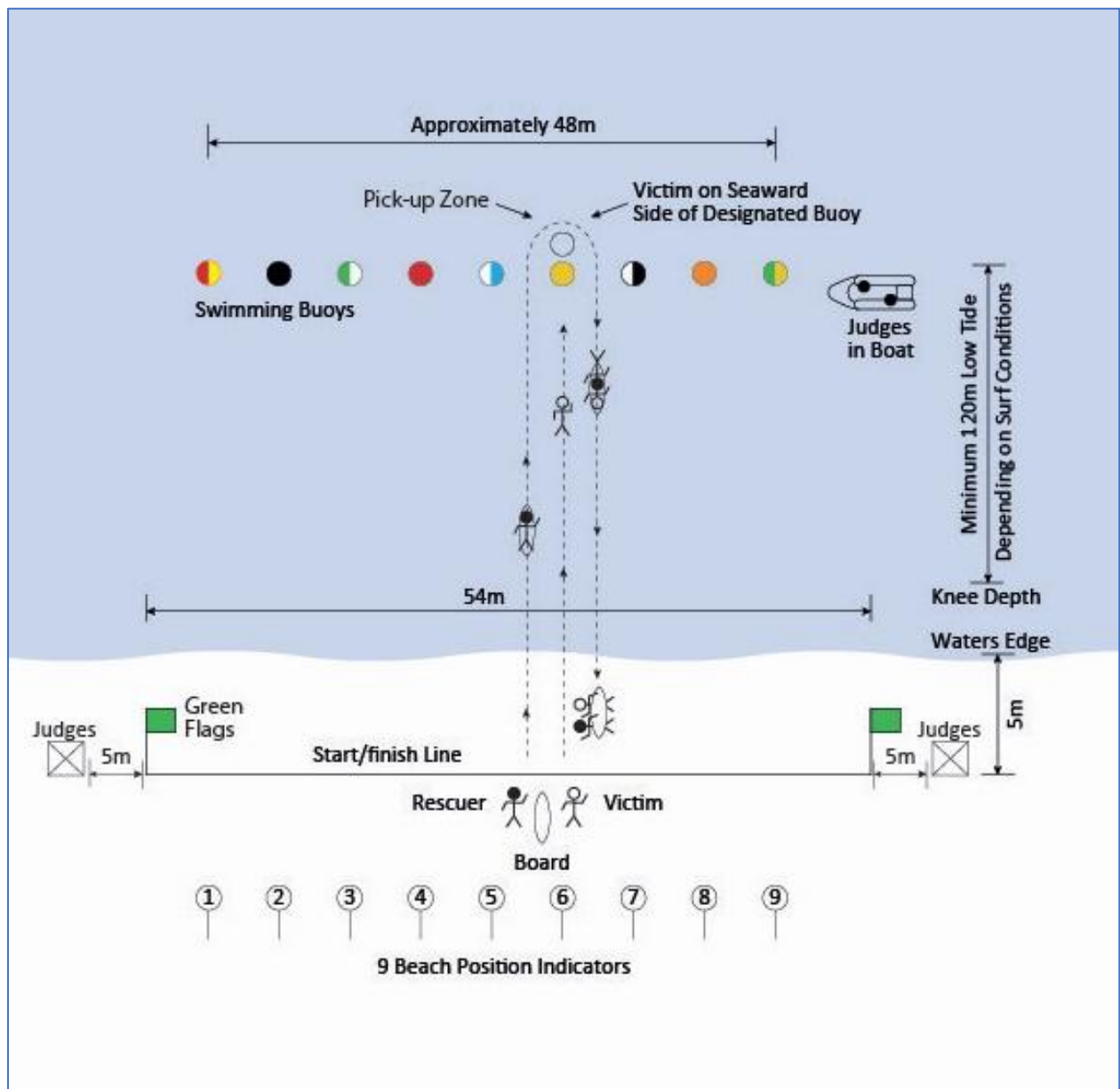

**FIGURE 31: BOARD RESCUE**

(Distances approximate only)

**Note:** The layout of the Competition Arena, including the beach setup relative to the positioning of the buoys, may be adjusted dependent upon the prevailing surf, sweep, and beach conditions.

## 20. OCEANMAN/OCEANWOMAN

### 20.1 Event description

Competitors cover a 1.4km (approx.) course that includes a swim leg, a board leg, a surf ski leg, and a beach sprint finish.

Except for the differences noted in this section, the conditions of racing of each leg are as generally required for the individual conditions of that discipline including the rules governing the component disciplines.

The sequence of legs shall be determined by draw at the commencement of each competition. The same ballot shall determine the order of legs for the Oceanman/Oceanwoman Relay.

If the surf ski leg is first, competitors will start with a typical in-water start.

**Starting positions:** Competitors must start the race from their allotted beach position. Competitors must commence craft legs from the correct allotted beach positions. The starting positions are reversed for the board and surf ski legs. For example, in a 16-competitor race in which a competitor has drawn position 1: the competitor commences the initial craft leg from position 1 but commences the other craft leg from position 16.

Competitor's 1 <sup>st</sup> craft leg starting position	1	2	3	4	5	6	7	8	...	16
Competitor's 2 <sup>nd</sup> craft leg starting position	16	15	14	13	12	11	10	9	...	1

**Handler:** A member of the competitor's team assists the competitor. A registered team coach, manager, or other registered team personnel are permitted to function as a handler. With the Chief Referee's approval, non-team members may also function as handlers.

Handlers shall:

- Not be required to wear a competition cap.
- Wear a distinctive high visibility vest.
- If required, hold the surf ski in a floating position as per the diagram or as directed by Officials.
- If required, place the board flat on the beach (i.e. no sand or other mounds underneath the Board) as directed by Officials.
- Make every effort to ensure that they and the equipment they are handling do not impede other competitors.
- Comply with all instructions of the Officials.

### 20.2 The course

Buoys shall be laid out for the swim, board, and surf ski legs as indicated in the following diagram.

To ensure fair starts and finishes, alignment of the start line and finish line to the buoys may be altered at the discretion of the Chief Referee, depending on the prevailing sea conditions.

**Buoy distances:** Swimming buoys shall be positioned at a minimum of 120m from knee-depth water at low tide mark.

The board leg buoys, and surf ski leg buoys shall be positioned approximately 50m and 100m respectively behind the swimming buoys. The board leg buoys should be approximately 17m apart and the surf ski buoys approximately 50m apart, with the surf ski "apex" buoy a further 10m to seaward.

**Flag layout:** Two green and yellow flags located approximately 20m from the water's edge designate beach turning marks. One shall be positioned in line with swim buoy number 2, the other in line with the swim buoy number 8.

Two green (or area coloured) flags 5m apart mark the finish line. They are positioned at right angles to the water's edge and approximately 50m from the first turning flag.

**Start and changeover line:** The start and changeover line shall be approximately 30m in length, centred on the swimming buoy number 1 approximately 5m from the water's edge, and marked by a 2m high pole at either end.

The start and changeover line serves as a start line if the board or swim leg is first. It serves as a board placement line for the board leg. Competitors are not required to cross the start and changeover line after the race has commenced.

**Board course:** The board leg is conducted from the start and changeover line to pass swim buoy one on the outside; round the board course buoys; return to the beach passing swim buoy 9 on the outside; and round the two turning flags.

**Surf ski course:** The surf ski leg is conducted with the skis starting from the surf ski floating position as per the diagram, around three surf ski course buoys, return to the beach and around the two turning flags. Competitors must pass on the outside of all buoys. Competitors shall not cut through the swim course or board course buoys.

**Swim course:** The swim leg is conducted from the start and changeover line, around the swimming buoys, return to the beach and around the two turning flags.

**Run leg course and finish:** The race shall be concluded when a competitor completes all legs. To finish, a competitor rounds the first turning flag right hand in, passes the second turning flag on the shoreward side, and finishes between the two finish flags.

**Note:** Competitors round the turning flags in the same direction as the buoys for each leg of the course.

**Masters:** If the Masters Oceanman/Oceanwoman swim course would exceed 120m because of prevailing surf conditions, two single buoys, laid a minimum of 10m apart at the 120m mark may be used. In such circumstances, the standard swim course will be used for the board leg and for the first and third turning buoys of the surf ski leg. An apex buoy placed 10m beyond the swim buoys will complete the surf ski course.

### 20.3 Masters Oceanman/Oceanwoman Variation

The Masters Oceanman/Oceanwoman is as per the standard Oceanman/Oceanwoman event except that the two green/yellow turning flags are placed approximately 15m apart and either on the shoreline or at knee depth water (as appropriate and taking into account prevailing surf conditions so as to minimise the run distance). The two green (or area coloured) finish flags are placed on the water's edge approximately 5m apart and approximately 5m from the second turning flag. If the first leg is the swim or board, the event starts at the water's edge. For the second and third leg handlers may hold the craft (as appropriate) in the water for the competitor pick up.

**Note 1:** if the changeover occurs in knee depth water a handler may hold their competitor's board in the water at the start/changeover line as determined by the Chief Referee.

**Note 2:** All other conditions shall remain unaltered from the standard course.

### 20.4 Equipment

Surf ski, paddle, and board: See Section 8.

- A. Changing of damaged craft: A board or surf ski shall not be changed during a section of the race unless it is damaged or becomes unseaworthy. Team members/handlers shall be permitted to assist in replacing the damaged craft, but only to the extent of placing other craft at the start and changeover line.
- B. Paddles: A lost, or damaged paddle may be replaced only after the competitor returns to the start and changeover line.
- C. Equipment removal: To assist with the safe conduct of the event, team members and/or handlers may remove damaged or abandoned equipment from the course during the race provided the progress of other competitors is not obstructed.

### 20.5 Judging

Judges shall be placed to observe the conduct of the event and to determine competitors' place at the finish. Competitors must finish on their feet in an upright position. The finish is judged on the competitor's chest crossing the finish line.

### 20.6 Contact with craft

Competitors must be in contact with the surf ski or board up to and including the last course buoy. Competitors shall not be disqualified if they lose contact with the craft on the return journey from the buoys. Competitors may lose contact on the way out without penalty provided they regain the craft and round the last turning buoy of each leg in contact with the craft and complete the course.

### 20.7 Disqualification

In addition to the General Rules in Section 2 and those outlined in S4-1 to 4-3, the following behaviour shall result in disqualification: Failure to complete the course as defined and described (DQ12).

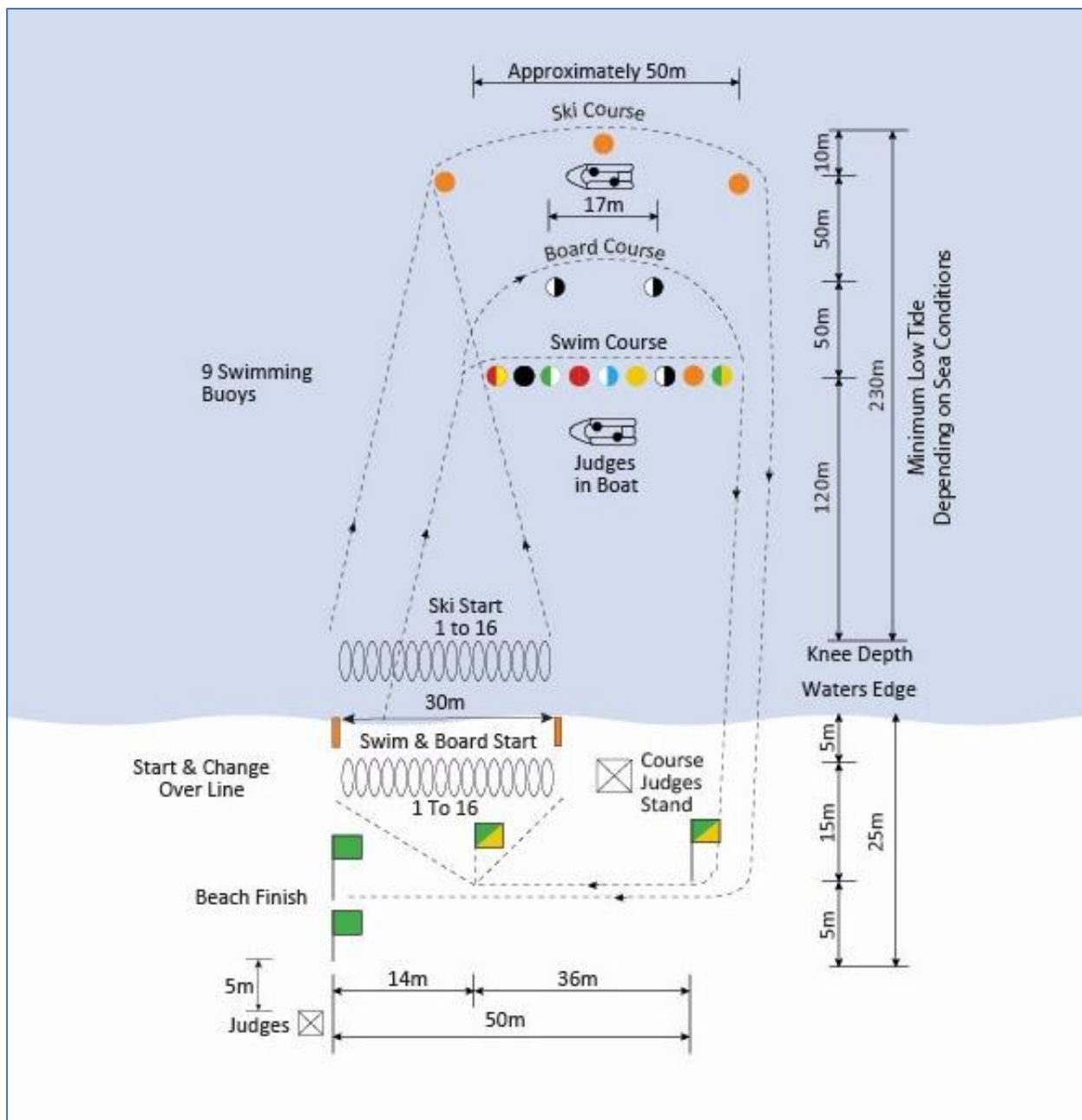

**FIGURE 32: OPEN AND YOUTH OCEANMAN/OCEANWOMAN.**

(Distances approximate only)

**Note:** The layout of the Competition Arena, including the beach setup relative to the positioning of the buoys, may be adjusted dependent upon the prevailing surf, sweep, and beach conditions.

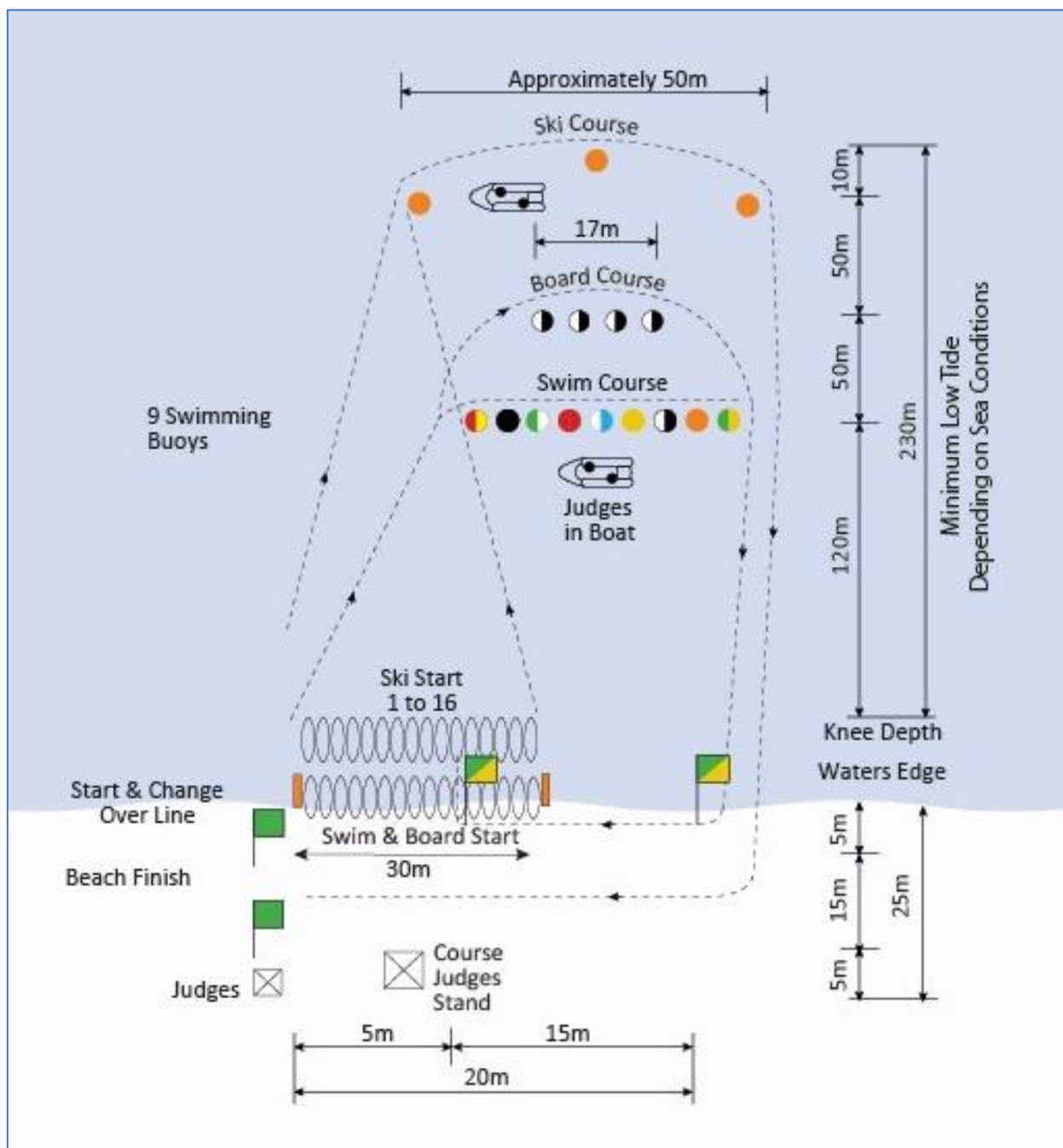

**FIGURE 33: MASTERS OCEANMAN/OCEANWOMAN AND OCEANMAN/OCEANWOMAN RELAY**

(Distances approximate only)

**Note 1:** The layout of the Competition Arena, including the beach setup relative to the positioning of the buoys, may be adjusted dependent upon the prevailing surf, sweep, and beach conditions.

**Note 2:** The turning flags are to be set by the Chief Referee or their designate considering water conditions at the time of a race e.g., the turning flags should be set back up to about 5m from the water's edge in the event of a steep drop off into the water and/or a heavy shore dump for safety, fairness, and practicality. However, on a flat beach and/or little wave surge, the turning flags may be placed at the water's edge or in the water to minimise the run distance. The changeover line may be placed on the beach or in the water depending on conditions and the placement of the turning flags.

## 21. OCEAN M (INDIVIDUAL)

### 21.1 Event description

Competitors cover a 1.64km (approx.) in-water course that includes a swim leg, a board leg, a surf ski leg, and a beach sprint finish.

Except for the differences noted in this section, the conditions of racing of each leg are as generally required for the individual conditions of that discipline including the rules governing the component disciplines.

Unless otherwise advised by the Organiser or Competition Committee, the fixed sequence of legs in the Ocean M shall be swim, board, and ski.

**Starting positions:** Competitors must commence the swim leg from their drawn position of the start line and the board leg. The starting positions are reversed after the board leg for the surf ski leg i.e., in a 16-competitor race in which a competitor has drawn position 1: the competitor commences the swim and board legs from position 1 but commences the ski leg from position 16.

Competitor's Swim leg starting position	1	2	3	4	5	6	7	8	...	16
Competitor's Board leg starting position	1	2	3	4	5	6	7	8	...	16
Competitor's Ski Leg starting position	16	15	14	13	12	11	10	9	...	1

### Craft Management/Handling:

**Personal Handlers:** A member of the competitor's team may, if required, assist the competitor with craft management. A registered team coach, manager, or other registered team personnel are permitted to function as a handler. With the Chief Referee's approval, non-team members may also function as handlers.

Personal Handlers shall:

- A. Not be required to wear a competition cap.
- B. Wear a distinctive high-visibility vest.
- C. Place craft as per the diagram or as directed by Officials.
- D. Make every effort to ensure that they and the equipment they are handling do not impede other competitors.
- D. Comply with all instructions of the Officials.

### Major Event Requirements:

At major competitions such as Life Saving World Championships, Olympic type promotional events and high-profile stand-alone events, a "competitor only" environment ("clean beach") is required and is essential for event presentation.

Particular requirements may include but not limited to:

- **Course Set Up:** Superior course set up with appropriate buoys and on beach presentation including, but not limited to, double fencing, banners, finish arches, flags, turning markers, VIP and other seating, video stands, interview areas, etc.
- **Entertainment:** Superior PA including pre- and pre- and post-race music and commentary.
- **Officials:** A limited, discrete, skilled, and specifically trained set of Officials are to be appointed for the Ocean M events. These Officials, if permitted onto the "field of play" during the conduct of a race, are to be "invisible" to both spectators and broadcasts, may include:
  - 1 Chief Referee (who will also start the race) and remains inconspicuous in the Competition Arena.
  - 1 x Safety Officer/Statistician. ^
  - 2 x Competitor Marshalls (who enter the Competition Arena only prior to the start of a race. to direct competitors. \*
  - 2 x Handler Marshalls (who only enter the area the Competition Arena to set craft with handlers and to direct handlers to their area prior to a race. They are to remain inconspicuous in the craft/handler area during the race.^
  - 1 x Finish Video Operator (if required). \*
  - 1 x Course Judge. ^
  - 1 Finish Judge (if required). \*

- 1 x Recorder (if required) \*
- 2 x Finish Banner Holders (if required). \*
- Other Officials (approximately 12) shall be placed around the outside perimeter of the Competition Arena to assist with crowd control and to assist maintain a “clean beach”. They do not enter the Competition Arena.

\* Officials who are hidden from view and emerge under the direction of the Chief Referee only to do their roles then immediately retire out of sight of both spectators and cameras.

^ Officials are off-beach during event conduct and only emerge if required at the direction of the Chief Referee.

**Note:** All Officials shall be trained and briefed on their specific duties prior to the event and are to wear matching uniforms. The expectation is that Officials are not to deviate from maintaining a clean beach during a race except in the event of an emergency situation.

- A. **Other Support:** Expert Commentators and Camera Operators etc. are to be appointed and are to wear matching uniforms for their respective roles. The Ocean M Event Director (if appointed) and Commentators are to be off beach or remain invisible during a race.
- B. **Competitor Handlers:** Handlers, if required, shall wear matching uniforms (if provided by Organisers). Handlers are to assist with initial craft placement prior to the start of the event or legs, to remove craft after use under the direction of a designated Official and then immediately return and remain in the Craft Storage Area located on the right-hand side of the course (looking to sea).

**Note:** Handlers are not required for the placement of craft in the Competition Arena for the Ocean M Lifesaver Relay Race as competitors will manage their own craft. After concluding their leg of a race competitors are to immediately leave the Competition Arena with their craft under the direction of a designated Official and remain in the Craft Storage Area located on the right-hand side of the course (looking to sea) and await the conclusion of the race.

- C. **Handling:** There are two primary options for handling at major events:

**Option 1 (Preferred):** Unless otherwise advised, a maximum of one handler per competitor shall be permitted to assist with initial craft placement prior to the start and to remove craft after use.

Prior to the start handlers shall move their competitor’s craft from the Marshalling Area on the left-hand side of the arena (looking to sea) and place the ski (and paddle) as directed in drawn order on a line about 5m from the water’s edge. Competitor boards shall then be placed in reverse to the drawn ski order on a line 10m behind the skis and in front of the start/ line. There will be an approximate 1.5m space between each ski and each board placed on the beach so that competitors are not impeded by craft. Unless otherwise advised ski paddles may be placed at the competitor’s discretion.

Under direction, and prior to the commencement of a race, the handler then relocates to the Craft Storage Area on the right-hand side of the arena (looking to sea). The handler is only permitted to re-enter the Competition Arena after each of the board and ski legs as directed to remove their competitor’s craft from the arena and to immediately return to the Craft Storage Area.

**Note:** Handlers are not permitted onto the Competition Arena to collect goggles from their competitor at the conclusion of the swim leg.

**Option 2:** Unless otherwise advised two handlers (handler 1 and handler 2) will be required for each competitor. Handler 1 will bring craft into the arena from the Marshalling Area on the left-hand side of the arena (looking to sea). Handler 2 will be located in the Craft Storage Area on the right-hand side of the arena (looking to sea).

Following the start of the swim leg handler 1 will move their competitor’s board from the Marshalling Area as directed and in drawn order and place the board about 5 metres from the water’s edge. There will be an approximate 1.5m space between each craft placed on the beach so that competitors are not impeded by craft. Handler 1 will then immediately leave the Competition Arena under the direction of a designated Official and remain in the Marshalling Area until directed to move the ski and paddle into the Competition Arena.

After all competitors have entered the water for the board leg of the race handler 1 shall move their competitor’s ski (and paddle) from the Marshalling Area as directed and in drawn order and place the board about 5m from the water’s edge. Unless otherwise advised ski paddles may be placed at the competitor’s discretion. Handler 1 will then immediately leave the Competition Arena under the direction of a designated Official and remain in the Marshalling Area until the conclusion of the race.

Handler 2 is located in the Craft Storage Area and is permitted to enter the Competition Arena only under the direction of a designated Official at the conclusion of the board leg and ski leg respectively to remove their competitor's craft from the arena and immediately return to the Craft Storage Area.

Following the conclusion of a race all handlers are to remove all craft from the vicinity of the Competition Arena.

**Note 1:** Handlers are not permitted onto the Competition Arena to collect goggles from their competitor at the conclusion of the swim leg.

**Note 2:** The Organisers may provide handlers for the event. In such cases any personal handlers shall not be allowed onto the Competition Arena during or following a race unless otherwise permitted.

**Note 3:** Prior to the commencement of a race competitors shall be permitted to check the placement of their craft in the Competition Arena.

- D. **Race Management:** A "mercy rule" may be applied as determined by event Organisers or Competition Committee for safety, timing, and/or presentation purposes i.e., should a competitor(s) still be on the course after all qualifiers for the next round are determined, or be lapped during the course of an event, the Chief Referee may, at their discretion, direct the removal of the competitor(s) from the course.

## 21.2 The course

Buoys shall be laid out for the swim, board, and surf ski legs as indicated in the following diagram.

To ensure fair starts and finishes, alignment of the start line and finish line to the buoys may be altered at the discretion of the Chief Referee, depending on the prevailing sea conditions.

To encourage spectator, public, media and sponsor interest special audio and visuals may also be utilised including changeover and finish arches, large in-water turning buoys, special on-beach turning markers/flags and on-beach grandstands.

**Buoy distances:** The swimming buoys shall be positioned approximately 90m from the water's edge and 50m apart.

The board leg buoys, and surf ski leg buoys shall be positioned approximately 50m and 100m respectively behind the swimming buoys. The board leg buoys should be approximately 55m apart and the surf ski buoys approximately 60m apart, with the surf ski buoys having an additional small marker buoy placed approximately 1m to the return side of each of the ski buoys to assist with ski turns.

**Markers:** A large turning marker (or two flags approximately one 1m apart) is to be placed in the centre of the beach at approximately knee depth water to the designate beach turning point at the half-way of each leg of the race. In the event that there is no shallow water the marker shall be placed at the water's edge.

Two further beach markers approximately 35m apart are to be placed on the beach directly behind the turning markers to form a semi-circular run track to the Finish/Change Arch line.

**Finish/Change Arch line:** The finish/change line is designated by a finish arch or twin flags placed 5m apart and in the centre of the arena and approximately 20m (tide dependent) from the water's edge. If a finish arch is erected the judging line shall be delineated by two flags on the incoming side of the arch.

**Note:** For the Ocean M Lifesaver Relay event the finish/change line shall also be the changeover line for team members in the event.

**Start line:** The start line shall be approximately 15m in width, centred on the swimming buoy number 1 approximately 30m from the water's edge, (beach and surf conditions permitting), and may be marked by poles at either end.

Competitors commence the event on the starter's signal and run to enter the water for the swim leg of the race.

**Note:** Competitors are not required to cross through the start line for any legs of the event.

**Swim course:** The swim leg is conducted around the first swimming buoy from left to right, return to the beach, around the turning marker(s) from right to left, then proceed again to sea, around the second swimming buoy from left to right and return to the beach past the first beach marker through the finish/change arch and past the second beach marker to commence the board leg.

**Board course:** The board leg is conducted from the pick-up of the board on the beach past swim buoy No.1 on the outside (i.e., the paddler stays to the left of the swim buoy No.1) and around the first board buoy from left to right and return to the beach passing swim buoy No.1 on the outside (i.e., the paddler stays to the left of the swim buoy No.1). The turning marker is then rounded from right to left, and the board is paddled past swim buoy No.2 on the outside (i.e., the paddler stays to the left of the swim buoy No.2) and around the

second board buoy from left to right, return to the beach passing swim buoy No.2 on the outside (i.e., the paddler stays to the left of the swim buoy No.2) to return to the beach and past the first beach marker, through the finish/change arch and past the second beach marker to commence the ski leg.

**Surf ski course:** The ski leg is conducted from the pick-up of the ski and paddle on the beach, past the swim, and board buoys No.1 on the outside (i.e., the paddler stays to the left of the swim and board buoys No.1) and around the first ski buoy (and the marker buoy) from left to right, return to the beach passing the board and swim buoys No.1 on the outside (i.e., the paddler stays to the left of the swim and board buoys No.1). The turning marker is then rounded from right to left and the ski is paddled past the swim and board buoys No.2 on the outside (i.e., the paddler stays to the left of the swim and board buoys No.2) and around the second ski buoy (and marker buoy) from left to right, passing board and swim buoys No.2 on the outside (i.e., the paddler stays to the left of the swim and board buoys No.2) to return to the beach and past the first beach marker and through the finish line and arch to complete the course.

**Run leg course and finish:** The race shall be concluded when a competitor completes all legs. . To finish, a competitor must past the first beach marker and through the finish at the finish arch (or through the two finish flags).

**Note 1:** Competitors round the turning flags in the same direction as the buoys for each leg of the course.

**Note 2:** If the swim buoy distance is to exceed 90m from the water's edge because of prevailing tide or surf or beach conditions, the Event Management Committee may decide to use the two board buoys for the swim. In such circumstances competitors shall not complete an M shape swim course but shall proceed around both board buoys without returning to the beach and then commence the "M" board leg.

**Note 3:** Should tide or surf or beach conditions make it impractical to set a suitable M shaped water course, the Event Management Committee may also alternatively decide to use the traditional Oceanman/Oceanwoman for the water legs of the event while retaining the on-beach course for the event.

### 21.3 Equipment

Surf ski, paddle, and board: See Section 8.

**Changing of damaged equipment:** A board, surf ski and/or paddle shall not be changed during a section of the race unless it is damaged or becomes unseaworthy. Team members/handlers shall be permitted to assist in replacing the damaged craft, but only to the extent of placing other craft at the edge of the Competition Arena was directed and under the direction of the Chief Referee.

**Equipment removal:** To assist with the safe conduct of the event, Officials at major events, or team members and/or handlers at other events may remove damaged or abandoned equipment from the course during the race at the direction of a designated Official provided the progress of other competitors is not obstructed and that the gear is not brought to shore within the confines of the Competition Arena.

### 21.4 Judging

Judges shall be placed to observe the conduct of the event and to determine competitors' place at the finish. Competitors must finish on their feet in an upright position. The finish is judged on the competitor's chest crossing the finish line.

### 21.5 Contact with craft

Competitors must be in contact with the surf ski or board up to and including the last course buoy. Competitors shall not be disqualified if they lose contact with the craft on the return journey from the buoys. Competitors may lose contact on the way out without penalty provided they regain the craft and round the last turning buoy of each leg in contact with the craft and complete the course.

### 21.6 Disqualification

In addition to the General Rules in Section 2 and those outlined in S4-1 to 4-3, the following behaviour shall result in disqualification: Failure to complete the course as defined and described (DQ12).

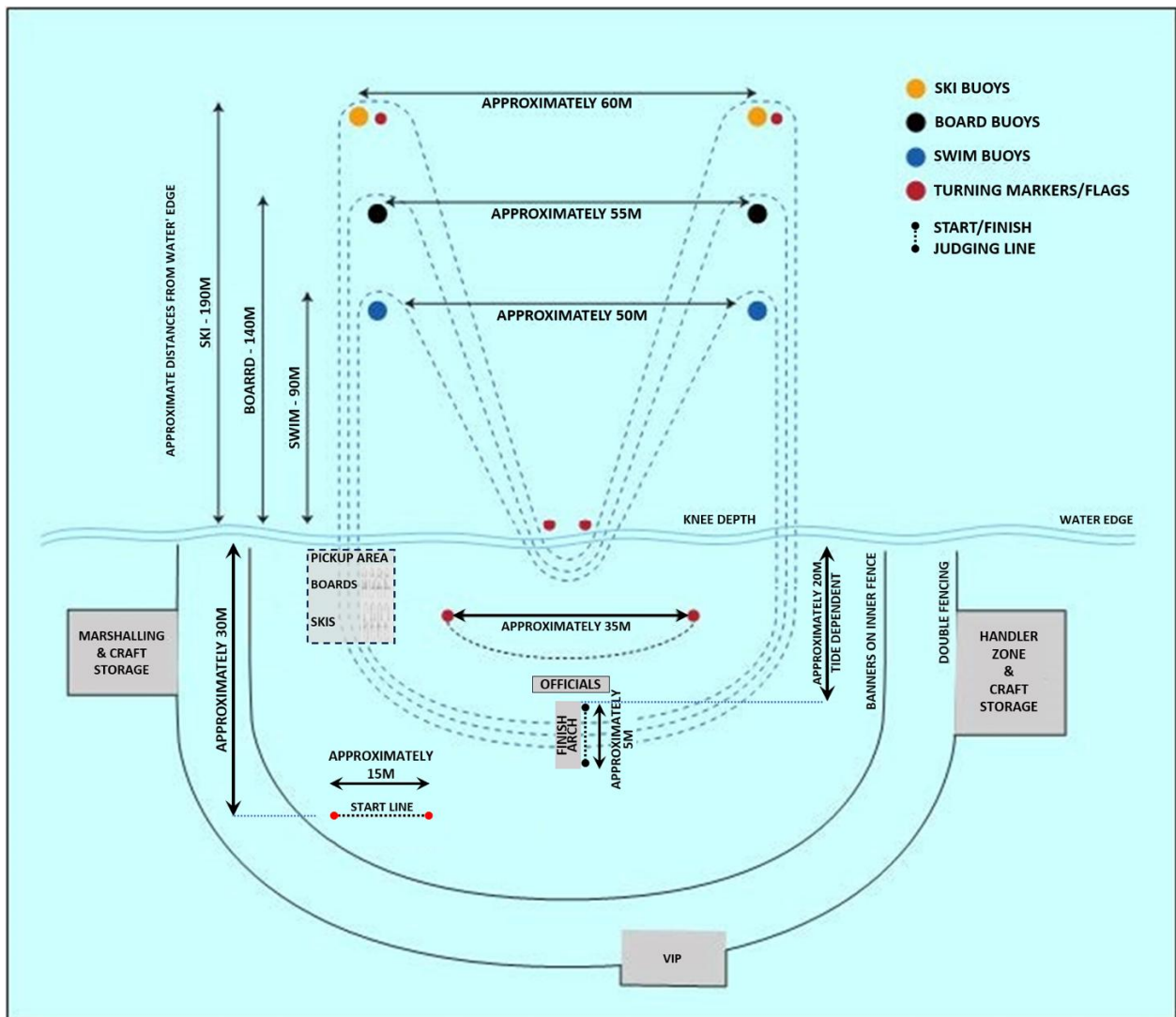

**FIGURE 34: INDIVIDUAL OCEAN M.**

(Distances approximate only)

**Note:** The layout of the Competition Arena, including the beach setup relative to the positioning of the buoys, may be adjusted dependent upon the prevailing surf, sweep, and beach conditions.

## 22. OCEANMAN/OCEANWOMAN ELIMINATOR VARIATION

### 22.1 Event Description

The Eliminator format is an alternate format to conduct the traditional Oceanman and Oceanwoman and the Ocean M Course events.

Qualification for the Elimination Event final is determined by heats and further rounds (where applicable) to arrive at a final of up to 16 competitors (see also the note). Unless otherwise advised by the Organiser or Competition Committee, any qualifying rounds for the Eliminator final shall be conducted as single races (i.e., not in the Eliminator format).

The final is conducted over three Eliminator races as follows:

- A. Race 1 eliminating the last 4 athletes
- B. Race 2 eliminating the last 4 athletes
- C. Race 3 (FINAL) 8 remaining athletes

**Note:** The Organiser may decide to have greater or less than 16 competitors in the first race of an Eliminator final and/or different elimination numbers in each Eliminator race. If this occurs the Organiser or Chief Referee shall advise the qualifiers and/or elimination numbers. prior to the conduct of the event.

Unless otherwise advised by the Organiser or Competition Committee, the order of legs for the rounds of the elimination finals shall rotate as follows:

- A. Race 1: swim, board, ski.
- B. Race 2: ski, board, swim.
- C. Race 3: board, swim, ski.

There will be 5 minutes rest between each race with the time commencing from the race winner crossing the finish line. This time can be subject to the Organiser's discretion based on conditions and advised prior to the Eliminator final commencing.

Rules for the Eliminator finals format shall be as per the traditional Oceanman/Oceanwoman or Ocean M as appropriate except where varied below:

- The final placing result (and any team point score points to be allocated) shall be dependent on the round and placing where a competitor is eliminated.
- Dependent on event promotion, area set up and/or conditions there may be longer or shorter courses and/or run legs for either format.
- Competitors who fail to complete the course correctly (including missing a turning buoy or mark) shall be subject to the following:
- If an error occurs in the first race of the eliminator round, then the competitor would be disqualified and allocated last place (and any relevant placing points).
- If the error occurs in the second or third race of the eliminator, then the competitor would be disqualified and allocated last place in that round. This is because the competitor has already qualified above those who have already been eliminated.
- The event winner is the competitor who correctly finishes first in the third (final) elimination race irrespective of what qualifying place they achieved in the first two eliminator races.
- Note: When racing occurs at "flat-water" venues an alternate course may be considered particularly when the events are conducted at standalone competitions. In such circumstances the course shall be advised by way of entry circular and should include a course diagram and the approximate distances for each leg.

### 22.2 Disqualification

In addition to the General Rules in Section 2 and those outlined in S4-1 to 4-3, the following behaviour shall result in disqualification: Failure to complete the course as defined and described (DQ12).

## 23. OCEANMAN/OCEANWOMAN RELAY

### 23.1 Event description

The Oceanman/Oceanwoman Relays are a variation of the individual Oceanman/Oceanwoman events.

Teams of four competitors (one swimmer, one board paddler, one surf ski paddler, and one runner) cover the course.

The sequence of legs determined by draw prior to the start of each competition.

The run leg is always the final leg. If the surf ski leg is first, competitors shall start with a typical in-water start.

**Masters:** Teams of three competitors – one swimmer, one board paddler, one surf ski paddler. There is no running leg in Masters Oceanman/Oceanwoman Relay (refer also below for event procedure variation).

Except for the differences noted in this section, the conditions of racing of each leg are as generally required for the individual conditions of that discipline including the rules governing the component disciplines.

To ensure fair starts and finishes, alignment of the start line and finish line to the buoys may be altered at the discretion of the Chief Referee, depending on the prevailing sea conditions.

Competitors must commence their leg of the event from the correct allotted beach position.

**Note:** The second and third competitors do not need to cross the start/changeover line to enter the water after being tagged.

The starting positions are reversed for the board and surf ski legs. For example, in a 16-team race in which a team has drawn position 1: the initial craft leg is commenced from position 1 but the other craft leg is commenced from position 16.

1 <sup>st</sup> craft leg starting position	1	2	3	4	5	6	7	8	...	16
2 <sup>nd</sup> craft leg starting position	16	15	14	13	12	11	10	9	...	1

**Note:** If the swim leg is the second or third leg of the race, competitors are to commence their leg of the race from the same drawn position of their team in the leg immediately prior to the swim leg.

The following event description assumes the order to be swim – board – surf ski – run. The course direction is clockwise.

For ease of explanation the draw for this event description is swim, board, ski and run:

**Swim leg:** From a beach start, swimmers enter the water, swim around the swimming course buoys, and return to the beach, run around the two green and yellow turning flags to tag with the board paddlers who are waiting with their boards, feet on, or on the shoreward side of, the start/changeover line.

**Board leg:** Board paddlers enter the water with their boards; pass swim buoy 1 on the outside; round the board course buoys; return to the beach passing swim buoy 9 on the outside; round the two turning flags, and through the start/changeover line to tag with the surf ski paddlers, who are waiting with their surf skis and paddles in approximately knee depth water.

On their return, board paddlers may leave their boards at the water's edge.

**Surf ski leg:** Surf ski paddlers paddle around the surf ski course buoys and return to shore to tag the runners waiting at the water's edge or in the water.

Paddlers must pass on the outside of all buoys. Paddlers shall not cut through the swim course or board course buoys.

The location of the tag is at the discretion of the team provided it occurs after the last swim course buoy and before the first turning flag.

**Run leg:** Runners then round one turning flag, pass the other flag on the shoreward side, and continue to the finish between the two green (or area coloured) finish flags.

**Note 1:** It is permitted to tag the competitor anywhere from the shoreward side of the last turning buoy to the first turning flag on the beach. All tags must be performed above the water surface so that they are visible.

**Note 2:** Runners are permitted to enter the water to be tagged by the incoming competitor and may wade, porpoise/duck dive\* off the bottom, catch waves and or run to the turning flag but are not permitted to swim at any time (this includes taking any over arm swimming action to either catch or stay on a wave).

\* Providing the feet push off the bottom, it is permitted to have an above water arm action as part of the porpoise/duck dive movement.

### 23.2 Equipment

Surf ski, paddle, and board: See Section 8.

Each team shall provide at least one board and one surf ski.

Team members shall place gear adjacent to the respective starting areas for the various craft.

**Equipment removal:** To assist with the safe conduct of the event, team members and/or handlers may remove damaged or abandoned equipment from the course during the race provided the progress of other competitors is not obstructed.

**Handlers:** A member of the competitor's team may, if required, assist the competitor with craft management. A registered team coach, manager, or other registered team personnel are permitted to act as a handler. With the Chief Referee's approval, non-team members may also function as handlers.

Handlers shall:

- A. Not be required to wear a competition cap.
- B. Wear a distinctive high-visibility vest.
- C. Place craft as per the diagram or as directed by Officials.
- D. Make every effort to ensure that they and the equipment they are handling do not impede other competitors.
- E. Comply with all instructions of the Officials.

### 23.3 Judging

Judges shall be placed to observe the conduct of the event and to determine competitors' place at the finish.

Competitors must finish on their feet in an upright position. The finish is judged on the competitor's chest crossing the finish line.

### 23.4 Contact with craft

Competitors must be in contact with the surf ski or board up to and including the last course buoy. Competitors shall not be disqualified if they lose contact with the craft on the return journey from the buoys. Competitors may lose contact on the way out without penalty provided they regain the craft and round the last turning buoy of each leg in contact with the craft and complete the course.

### 23.5 Masters Oceanman/Oceanwoman Relay Procedure Variation

The Masters Oceanman/Oceanwoman relay is as per the standard Oceanman/Oceanwoman Relay event except that the two green/yellow turning flags are placed approximately 15metres apart and either on the shoreline or at knee depth water (as appropriate and taking into account prevailing surf conditions so as to minimise the run distance). The two green (or area coloured) finish flags are placed on the water's edge approximately 5m apart and approximately 5m from the second turning flag. If the first leg is the swim or board, the event starts at the water's edge. For the second and third legs swimmers and craft competitors (as appropriate) may commence in the water.

**Note 1:** Dependent on conditions Officials may direct the depth to which competitors may enter the water to await the tag from incoming competitors.

**Note 2:** All other conditions shall remain unaltered from the standard course.

### 23.6 Disqualification

In addition to the General Rules in Section 2 and those outlined in S4-1 to 4-3, the following behaviour shall result in disqualification: Failure to complete the course as defined, described, and illustrated (DQ12).

## 24. OCEAN M LIFESAVER RELAY

### 24.1 Event description

The Ocean M Lifesaver Relay is a variation of the Individual Ocean M event.

Teams of four competitors (one swimmer, one board paddler, one surf ski paddler, and one runner) complete the course.

**Note 1:** The one runner completes all four run legs of the Ocean M Lifesaver Relay.

**Note 2:** Teams competing in the Life Saving World Championships National Teams and Interclub Mixed Ocean M Lifesaver Relay events must each consist of two men and two women. Teams may select the legs of the event in which their two men and two women competitors participate.

Unless otherwise advised by the Organiser or Competition Committee, the fixed sequence of legs in run – swim - run – board - run – ski - run. The course direction is clockwise unless otherwise directed.

Except for the differences noted in this section, the conditions, course, and rules are as per the Individual Ocean M event.

The runner is not permitted to wear shoes unless otherwise approved by the Chief Referee.

**Note 1:** The Major Events requirements that apply to the Individual Ocean M Event are equally essential to the conduct of the Ocean M Lifesaver Relay with the exception that handlers are not required in the Relay event as competitors will handle their own craft under the direction of designated Officials i.e. competitors bring in their own craft into the Competition Arena under the direction of a designated Official and also remove the craft after use as directed.

**Note 2:** Handlers may only assist prior to the commencement of a race by bringing craft into the marshalling area only.

### 24.2 The course

The course shall be as per the Ocean M Lifesaver Relay diagram.

**Start line:** The start line shall be approximately 15m in width, centred on the swimming buoy number 1 approximately 30m from the water's edge, (beach and surf conditions permitting), and may be marked by poles at either end.

**Note:** Competitors are not required to cross through the start line for any legs of the event.

**First Run Leg** The event commences on the starter's signal with an approximate 30m run leg that is conducted from the start line to the water. The runner shall then visibly tag with their swimmer who shall be waiting at their discretion at the water's edge or in the water.

**Note:** Runners are permitted to enter the water to tag their competitor and may wade, porpoise/duck-dive\* off the bottom with their feet but are not permitted to swim at any time before tagging with their competitor.

\* Providing the feet push off the bottom, it is permitted to have an above water arm action as part of the porpoise/duck dive movement.

**Swim Leg:** The swimmer swims around the "M" swim course and returns to the beach and visibly tags with their runner. The tag can be effected anywhere between the last turning buoy and the seaward side of the first beach marker.

**Second Run Leg:** After tagging with the swimmer the runner proceeds around the finish arch and then visibly tags their board paddler who shall be waiting with their board at their discretion at the water's edge or in the water.

**Note:** The runner's tag and actions are as per the "note" for the first run leg.

**Board course:** The board paddler paddles around the "M" board course, returns to the beach, and visibly tags with their runner. The tag can be effected anywhere between the last turning buoy and the seaward side of the first beach marker.

**Note:** The runner's tag and actions are as per the "note" for the swim leg.

**Third Run Leg:** After tagging with the board paddler the runner proceeds around the finish arch and then visibly tags their ski paddler who shall be waiting with their ski and paddle at their discretion at the water's edge or in the water.

**Note:** The runner's tag and actions are as per the "note" for the first run leg.

**Ski Course:** The ski paddler paddles around the “M” ski course, returns to the beach, and visibly tags with their runner. The tag can be effected anywhere between the last turning buoy and the seaward side of the first beach marker.

**Note:** The runners tag and actions are as per the “note” for the swim leg.

**Fourth Run Leg:** After tagging with their ski paddler the runner passes the first beach marker and through the finish judging line at the Finish Arch/flags to conclude the race.

**Note 1:** The runner’s tag and actions are as per the “note” for the first run leg.

**Note 2:** Competitors round the turning flags in the same direction as the buoys for each leg of the course.

**Note 3:** If the swim buoy distance is to exceed 90m from the water’s edge because of prevailing tide or surf or beach conditions, the Event Management Committee may decide to use the two board buoys for the swim. In such circumstances competitors shall not complete an M shape swim course but shall proceed around both board buoys without returning to the beach and then commence the “M” board leg.

**Note 4:** Should tide or surf or beach conditions make it impractical to set a suitable M shaped water course, the Event Management Committee may also alternatively decide to use the traditional Oceanman/Oceanwoman for the water legs of the event while retaining the on-beach course for the event.

#### **24.2 Course Variations**

If the swim buoy distance is to exceed 90m from the water’s edge because of prevailing tide or surf or beach conditions, the Competition Committee may decide to use the two board buoys for the swim. In such circumstances competitors shall not complete an M shape swim course but shall proceed around both board buoys without returning to the beach and then commence the “M” board leg.

Should tide or surf or beach conditions make it impractical to set a suitable M shaped water course, the Competition Committee may also alternatively decide to use the traditional Oceanman/Oceanwoman for the water legs of the event while retaining the on-beach course for the event.

#### **24.4 Disqualification**

In addition to the General Rules in Section 2 and those outlined in S4-1 to 4-3, the following behaviour shall result in disqualification: Failure to complete the course as defined and described (DQ12).



## 25. DISQUALIFICATION CODES FOR BEACH AND OCEAN EVENTS

Code and Disqualification	Events
1. Not competing in accordance with the general rules.	All events
2. A competitor or team may be disqualified if a competitor, team, or handler is deemed to have competed unfairly. Examples of “competing unfairly” include: <ul style="list-style-type: none"> <li>• Committing a doping or doping-related infraction.</li> <li>• Impersonating another competitor.</li> <li>• Attempting to defeat the ballot or draw for events or positions.</li> <li>• Competing twice in the same individual event.</li> <li>• Competing twice in the same event in different teams.</li> <li>• Purposely interfering with a course to gain advantage.</li> <li>• Jostling or obstructing another competitor or handler so as to impede their progress.</li> <li>• Receiving physical or material outside assistance (other than verbal or other direction)</li> <li>• Participating contrary to the spirit of the competition (as described in the code of fair play).</li> </ul>	All events
3. Competitors may not be permitted to start in an event if they are late reporting to the Marshalling Area. This may be noted as a “did not start” (DNS) or similar on the result sheet.	All events
4. A competitor or team absent from the start of an event shall be disqualified except for the A- or B Final. This may be noted as a “did not start” (DNS) or similar on the result sheet.	All events
5. Activities that result in wilful damage to the venue sites, accommodation sites or the property of others will result in disqualification from the competition of the individuals involved.	All events
6. Abuse of Officials may result in disqualification from the competition.	All events
7. The first competitor or team to start (i.e., initiating a starting motion) before the starting signal has been given shall be disqualified – except for Beach Flags in which the competitor(s) shall be eliminated	All events
8. Failing to comply with the starter’s commands within a reasonable time. <b>Note:</b> In beach flag events any such competitors shall be eliminated from the event.	All events
9. A competitor who, after the starter’s first command, disturbing others in the race through sound or otherwise may be disqualified (or eliminated in Beach Flags).	All events
10. Starting from a position other than the allotted position or lane.	All events
11. Picking up or blocking more than one baton – e.g., lying on a baton or covering a baton from sight.	Beach Flags
12. Failure to complete the event and/or course as defined and described.	All events



**World Water Safety  
INTERNATIONAL LIFE SAVING FEDERATION**

**ILS COMPETITION RULE BOOK**

**SECTION 5  
SIMULATED EMERGENCY RESPONSE COMPETITION**



**2025 EDITION  
(Revised May 2026)**

## SECTION 5

### SIMULATED EMERGENCY RESPONSE COMPETITION

The Simulated Emergency Response Competition (SERC) includes Wet and Dry SERC. The SERC events may be held in a variety of indoor and outdoor swimming pool or open water aquatic (wet) environments or in non-aquatic (dry) environments.

The Wet SERC tests the initiative, judgement, knowledge, and abilities of four lifesavers who, acting as a team – under the direction of a team leader – apply lifesaving skills in a simulated emergency situation unknown to them prior to the start. The Wet SERC is judged within a two-minute time limit.

The Dry SERC tests the initiative, judgement, knowledge, and abilities of two lifesavers who act as a team and apply first aid skills in a simulated emergency situation unknown to them prior to the start. The Dry SERC is judged within a three to five minute time limit.

In both the Wet and Dry SERC all teams respond to the same scenario (for the respective events) and are evaluated by the same judges. Every effort will be made to ensure that the scenarios are executed in the same manner for every team.

The Simulated Emergency Response Competition shall be conducted without male and female categories. Teams may consist of any combination of males or females.

#### 1. GENERAL CONDITIONS FOR SIMULATED EMERGENCY RESPONSE COMPETITION

- A. Team management and competitors are responsible for being familiar with the competition schedule, and with the rules and procedures governing the competition.
- B. Teams may not be permitted to commence in the SERC event if they are late reporting to the Marshalling Area. To assist the Organisers in determining how many heats may be required, events may be marshalled the day before or at the start of the day the event is scheduled.
- C. The Chief Referee shall decide whether the competition shall be conducted in heats, quarterfinals, semi-finals, or finals. An A-final may not have more than 32 teams of four.
- D. If heats are conducted the top 16-point scoring teams shall be assigned places in the final. If heats are conducted simultaneously in separate areas with separate judges in different “wet tanks” (for the Wet SERC) or “dry areas” (for the Dry SERC) the top teams from each competition tank/area will progress to the final (e.g., if there are four tanks/areas used for the heats, the top four teams from each tank/area will progress to the final). When a tie occurs that qualifies for a final the tied teams shall all advance to the final. Should one or more teams withdraw from the final, up to a maximum of four teams shall be called forward from the reserves list. Reserves will come from the same tank/area as the withdrawn team provided that marshalling lock-up has not closed for the event. The final shall not be re-seeded.
- E. The order of teams shall be determined by draw in a method approved by the Chief Referee.
- F. Any written instructions provided in lock-up, which are required for the management of the simulated emergency, shall be provided in English. Each team may bring one additional person into lock-up to provide interpretation/translation of the English instructions. This person remains in lock-up with the team.  
**Note:** Organisers should allow sufficient time for translation of verbal or written instructions.
- G. Competitors shall report promptly to the lock-up area at the designated time before the start of the competition. A team that is absent from lock-up at the start of the competition shall be disqualified (DQ3).
- H. Competitors shall treat and handle victims with care: verbal and physical abuse is unnecessary and inappropriate and may result in penalty or disqualification (DQ10).
- I. Competitors may wear corrective eyewear such as glasses and contact lens. Loss of such eyewear shall not be grounds for protest or appeal. Corrective goggles or masks are not permitted.
- J. Body tape used for preventative, medical, therapeutic or kinesiology purposes is allowed at the discretion of the Chief Referee if it does not provide a competitive advantage.
- K. Team members from the same team shall wear their Official team swim cap. In both Wet and Dry SERC events Ocean event caps, or rubber or silicone caps may be worn. A competitor shall not be disqualified if the cap is displaced or lost after the start of an event provided that Officials could identify that the competitor correctly completed the event.

- L. No other personal belongings or equipment are permitted in the Competition Arena (e.g., watches, phones or any other communication device, goggles, masks, fins). Competitors may be required to remove jewellery which might cause harm to the rescuer or victim.
- M. Judges scores are not subject to protest.

### 1.1 Security and lock-up

Before the start and throughout the competition, teams are isolated in a secure “lock-up” area out of sight and sound of the Competition Arena. The scenario, actors, and any equipment shall be secret until competitors are locked up.

After competing, a team may observe subsequent teams compete.

Teams in lock-up are not permitted to see or communicate with anyone who is not also in lock-up. Any device that would allow such communication is prohibited.

### 1.2 Competition start

One at a time, teams are escorted from lock-up to the competition area where, following an acoustic signal, they are confronted with “victims” who may be in various locations and need various types of assistance.

Actors will begin their victim simulations immediately prior to the acoustic starting signal, and as the team enters the competition area. At the acoustic signal competitors respond to the victims in any manner they wish within the time limit.

### 1.3 Competition Arena: Aquatic Environment (Wet SERC)

The aim of the aquatic Wet SERC is to demonstrate how lifesavers work as a team in performing some or all of the skills associated with emergency response situations in an aquatic environment.

The Wet SERC may be conducted in indoor and outdoor swimming pool or open water aquatic environments.

Unless otherwise advised all Lifesaving World Championship SERC events shall be conducted as wet events.

Simulated aquatic emergency scenarios are unknown until the start of the competition and shall be designed using one or more of the following approaches:

- An amalgam of single or multiple victim situations which are related.
- A group of victims involved in several situations which relate to a common theme, such as a pool party, an upturned crowded boat, missing person, or a workplace accident, etc.
- The inclusion of additional victims and bystanders with medical or physical conditions requiring emergency care such as an unconscious, shock, injured, heart attack, or stings or bites, etc.
- Simulated emergencies shall be staged as realistically (and as safely) as possible and should not test the competitors' imagination. For example, if a situation requires a burns victim there should be simulated evidence of a fire, or electrical wire, or chemicals.

**Note:** The use of live wires, or actual chemicals or other evidence that could cause real danger to the victims or competitors shall not be used.

The situation may evolve (e.g., a conscious victim becomes unconscious) during the scenario provided that:

- Delineating marks on the victim reflect the potential change to victim status.
- That there is consistent timing in the change occurring.
- That any change is consistent for every competitor throughout the competition.

The Competition Arena shall be clearly defined to all teams in advance. There shall be a clear indication of the location of both entry and exit points from the scenario area (e.g., which pool sides can be used).

Competitors shall be advised in advance if there are water or land entry or exit points that may be used or not used in undertaking the SERC.

Unless otherwise advised, competitors shall assume that the conditions in the Competition Arena are “as found.”

When electronic timing is available, it must be used as a countdown clock for competitors and spectators.

### 1.4 Competition Arena: Non- Aquatic Environment (Dry SERC)

The aim of a non-aquatic “Dry” SERC is to demonstrate how lifesavers work as a team in performing some or all of the skills associated with emergency response situations in a non-aquatic environment.

Because of the non-aquatic nature of the Dry SERC, this event variant focusses more on first aid techniques rather than rescue of victims (although there may be some movement required as part of the scenario to ensure the safety of victims).

Like the Wet SERC, the Dry SERC emergency scenarios are unknown until the start of the competition. The scenario will be selected from seven identified medical conditions outlined in Annexure 1 using one or more of the following approaches:

- The event will be conducted in an appropriate environment and location. Where it is conducted adjacent to water the test shall be set to ensure competitors are NOT required to enter the water.
- **Note:** Victims requiring assessment/treatment will not be in the water.
- Include between two and four victims with specific medical conditions such as, non-breathing, fracture, or sprain/strain.
- Simulated first aid emergencies shall be staged as realistically (and as safely) as possible and should not test the competitors' imagination. For example, if a situation involves a victim who is bleeding, there should be simulated evidence of this.
- **Note:** The use of actual blood or chemicals or other evidence that could cause real danger to the victims or competitors shall not be used.
- The role-playing may evolve (e.g., a person has a seizure) during the scenario noting that:
  - there is consistent timing in the change occurring.
  - any change is consistent for every competitor throughout the competition.

### 1.5 Situation scenarios

Both Wet and Dry SERC scenarios are to remain secret until the start of the competition, and are designed using one or more of the following approaches:

- A. An amalgam of single or multiple-person situations which are related.
- B. A group of people involved in a number of situations which relate to a common theme, such as a pool party or an upturned crowded boat.
- C. A number of groups of people in a number of multiple themes.
- D. One or more identified medical conditions

Simulated emergencies shall be staged as realistically (and as safely) as possible and not test the competitors' imagination. For example, a situation in which an actor complains of burned hands should be staged with simulated evidence of a fire, or electrical wire, or chemicals. (Real fire, live wires, or actual chemicals shall not be used.)

### 1.6 Victims, manikins, and bystanders

Victims shall be role-played by actors who present different problems necessitating different types of aid. For example, in Wet SERC victim types may include simulated non-swimmers, weak swimmers, injured swimmers, and unconscious victims. In Dry SERC victims will demonstrate one of the victim medical conditions. In addition, competitors may be confronted by resuscitation manikins in the role of "victim" as well as by bystanders and swimmers.

The role-playing may evolve (e.g., a conscious victim becomes unconscious) during the course of the scenario providing that marks reflect the change, that there is consistent timing in the change, and that the change is consistent for every competitor throughout the competition.

Competitors shall be notified before the start if victim type is to be signified by a symbol (e.g., a red/black cross on forehead indicating unconsciousness). Competitors shall treat manikins as non-breathing, pulseless victims.

**Note 1:** A bystander in a competition is not in immediate danger.

**Note 2:** Only **simulated CPR** should be applied to live human victims that are designated as being non-breathing, pulseless victims.

### 1.7 Equipment

Competitors may use all material and equipment available within the Competition Arena.

In the Wet SERC competitors may not bring their own equipment into the Competition Arena.

In Dry SERC events unless otherwise advised competitors will be required to bring a first aid kit which should include the following contents:

- Pocket Masks - 2
- Disposable gloves – 6 pairs
- gauze pads (7.5 cm) – 4
- Roll gauze - 4
- Triangular bandages - 4
- Compression bandage 1
- Ring Bandage - 1
- Set of Splints – 1 set
- Instant Cold Pack - 1
- Instant Hot Pack - 1
- Sterile water bottle - 2
- Blankets – 2

### **1.8 Start and timekeeping**

An acoustic signal will indicate the start and finish of each team's emergency response.

## **2. PRINCIPLES OF RESCUE**

### **2.1 Lifesaver versus lifeguard response**

SERC competitors are expected to respond as a group of individual lifesavers acting in a coordinated team and in the Wet SERC under the direction of a team leader.

Lifesavers must be prepared to respond appropriately in unexpected emergencies and sometimes without the benefit of specialised equipment, back-up, or established procedures and communications systems. In such circumstances, the personal safety of the lifesaver is paramount at all times, and this shall be reflected in the marking sheets.

A. Competitors apply the following basic rescue steps:

- Recognition of a problem
- Assessment of the situation
- Plan a course of action to overcome the problem.
- Assessment of dangers
- Action to effect the rescue
- Care of the victim

B. When assessing the situation, competitors consider:

- Capabilities of the rescuer
- Number of victims
- Position of the victims
- Condition of the victims (e.g., non-swimmer, weak swimmer, sprained ankle)
- Rescue aids (equipment) available.
- Conditions prevailing (e.g., water depth, entry, and landing points)

C. On the basis of their assessment, competitors plan a course of action which may involve:

- Seeking assistance
- Organising assistance
- Informing an available helper
- Gathering any appropriate aids or equipment
- Performing the rescue and/or providing first aid as necessary

D. The plan should establish control of the situation and aim to preserve as many lives as possible. The management of a rescue of multiple victims presents rescuers with choices.

E. In brief, rescuers should manage the situation as follows:

- Mobilise the mobile
- Secure the safety of those in imminent danger
- Recover and resuscitate those in need of continuous care

- F. The mobile may include those capable of assisting themselves to safety. In the Wet SERC those in imminent danger may include non-swimmers and injured swimmers. Those in need of continuous care include unconscious, non-breathing, or suspected spinal-injured victims.
- G. When a suitable plan has been devised it should be put into action promptly. Competitors should be alert to changes in the situation and adapt their plan of action to respond to such changes.
- H. When undertaking rescues or providing first aid, competitors must remember:
- Rescue from a position offering greatest safety to oneself
  - The management of rescue principles
  - Approach victims with extreme caution
  - Avoid direct personal contact with conscious victims unless they are providing first aid
- I. If entering the water is inevitable, competitors select the most effective techniques for the situation without endangering their own life in any way.
- J. It is important that competitors clearly show their intentions and actions to the Judges.

### 3. JUDGING AND MARKING

The marking sheets shall be prepared with one Judge marking the overall scenario while the others judge the handling of the individual victims. One Judge per victim is recommended.

Before the competition start, Judges shall be briefed on the situation scenarios, scoring procedure, and marking priorities.

A Judge shall be assigned to a victim or group of victims and assess all teams in that part of the scenario for the entire competition.

#### 3.1 Marking system

The marking system used in both the Wet and Dry SERC allows Judges to use their skill in assigning marks and provides for a competitor offering an appropriate but unanticipated rescue response. In allocating marks, Judge(s) consider the following:

- Victim type
- Victim's distance from safety
- Equipment available and used
- Speed of assessment
- Priority given
- Quality of action/task
- Victim care

Early and accurate recognition of the victim's problem(s) is the essential first step to success in this competition. Successful recognition is closely related to the quality of the victim simulation and staging of the incidents.

**Scoring shall reward the competitors' accurate assessment of which victims take priority.** The competitors' assessment of which victims take priority will depend on the nature of the emergency. In Wet SERC events involving in-water victims, competitors should follow these victim priorities in determining whom to help first:

- Weak swimmers and others who are mobile
- Victims in imminent danger: non-swimmers and injured swimmers
- Victims requiring continuous care: unconscious, non-breathing, suspected spinal-injured victims.

Specific aspects of the scenario may be weighted to provide higher scores for a rescue performance requiring a greater degree of skill and judgement.

Refer also to the Coach, Competitor Judge, and Technical Official's Guide and the sample score sheets at the end of this section (Annexure 1).

Please note that these score sheets are samples only. Unique scenarios, marks, and weighting and competition-specific score sheets are to be designed for each competition.

#### 3.2 Disqualification

In addition to the General Rules in Section 2 and the General conditions for Simulated Emergency Response Competition in 5.2, the following behaviour may result in disqualification:

- Receiving outside assistance, direction, or advice (DQ7).

- Taking any telecommunication device into the security area (DQ8).
- Using any equipment not provided as part of the competition (DQ9).
- Competitors who verbally or physically abuse a victim may be assigned a penalty or be disqualified (DQ10).

#### 4. DISQUALIFICATION CODES FOR SERC

Code and Disqualification	Events
1. Not competing in accordance with the general rules.	All events
2. A competitor or team may be disqualified if a competitor, team is deemed to have competed unfairly. Examples of “competing unfairly” include: <ul style="list-style-type: none"> <li>• Committing a doping or doping-related infraction.</li> <li>• Impersonating another competitor.</li> <li>• Attempting to defeat the ballot or draw for events or positions.</li> <li>• Team competing twice in the same event.</li> <li>• Individual competing twice in the same event in different teams.</li> <li>• Receiving physical or material outside assistance (other than verbal or other direction)</li> <li>• Participating contrary to the spirit of the competition (as described in the code of fair play).</li> </ul>	All events
3. Competitors may not be permitted to start in an event if they are late reporting to the Marshalling Area. This may be noted as a “did not start” (DNS) or similar on the result sheet.	All events
4. A competitor or team absent from the start of an event shall be disqualified except for the A-Final. This may be noted as a “did not start” (DNS) or similar on the result sheet.	All events
5. Activities that result in wilful damage to the venue sites, accommodation sites or the property of others will result in disqualification of the individuals involved from competition.	All events
6. Abuse of Officials may result in disqualification from the competition.	All events
7. Receiving outside assistance, direction, or advice.	SERC
8. Taking any telecommunication device into the security area.	SERC
9. Using any equipment not provided as part of the competition.	SERC
10. Competitors who verbally or physically abuse a victim may be assigned a penalty or be disqualified.	SERC

## ANNEXURE 1:

### SERC COACH, COMPETITOR, JUDGE, AND TECHNICAL OFFICIAL'S GUIDE

#### Purpose

The purpose of this document is to provide coaches, competitors, judges and technical officials with:

- A broad understanding of the principles of judging the Simulated Emergency Response Competition (SERC) event, which includes Wet and Dry SERC.
- The structure and content of judging sheets aligned to the priorities and principles of rescue outlined in the 2025 Edition of the ILS Rule Book.

The ILS gratefully acknowledges the work of colleagues in Lifesaving Canada in creating this guide.

#### Definition Of Terms

**Area** means the area in which the SERC competition is to be conducted. It can vary dependent on the scenario and, as required, will be advised by the officials conducting the event.

**Bystander** means a person who role plays as a trained or untrained individual who may assist in the rescue under the direction of the lifesaver.

**Victim** means a person who role plays as a victim type such as weak or tired, injured, unconscious, or non-swimmer.

**Rescue** means to assess the situation, plan a course of action to overcome the problem, perform actions to effect the rescue, and provide aftercare to the victims.

**Rescue aid** means to select an appropriate equipment item that is available in the competition area and can be utilized effectively during the rescue.

**Securing** means to make safe from imminent danger with a rescue technique such as a throwing line/rope, reaching pole/object, throwing a ring/buoyant aid, craft/boat, support with a tow/carry.

**Landing** means to safely remove the victim from the water and position them safely on the beach, dock, or pool deck.

**Treatment** means the actions provided by the rescuers to the victim to address the injury/condition they are presenting.

#### Marking System

- Overall, a weighted marking system is used however the judge's use direct marking and the weighting is tallied by using a weighting factor during the final results collation.
- The direct marking component requires each judge to observe their section and allocate up to 10 marks in each of the five sections to provide a relatively objective basis for judging. This enables each judge to provide a score from 0-10 in all sections of the judge scoring sheets to ensure that a consistent value is applied to each team performances.
- The relative merit / value of the rescuer performance in each section is accounted for by the application of a weighting factor to the raw score in each component in that section. This provides higher scores for a rescue performance requiring a greater degree of skill, judgment or priority. The Scenario Design Team, approved by the Chief Referee, determines the weighting factors based on the specific test elements which are then factored into the final event recording sheets. Refer to the Weighting Factor section below.
- The judge scoring sheets are separated into essential elements grouped into 5 sections with 10 marks assigned to each section with a raw total of 50 marks.
- Judges should avoid using a pass/fail criteria based on their lifesaving principles and may use the full range of marks available. Therefore, when allocating marks judges must assess the competitor's actions when rescuing / treating a victim. They must analyse the rescue performance against pre-determined criteria. Marks should not be withheld in anticipation of a better performance by another team.
- It is important that judges ensure that their allocation of marks will rank the team's performance in a consistent manner throughout the whole event and that those who compete earlier in an event are not disadvantaged by an overly cautious allocation of marks. This will not occur providing the allocation of marks is consistently applied **based on performance** from the first to last team. Judges may want to create a rubric for points allocations to be used across all teams for their specific victim.

- Judges need to be aware that some teams may have one competitor dealing with a victim where other teams may have several different competitors' dealing with the victim. To ensure a consistent measure of the team performance, the judge's focus needs to remain on the victim to ensure an on-going evaluation of the victim's condition, and the actions performed, throughout the rescue / treatment.

### Marking Scale

The following ranking scale provides an overview and acts as a guide for judges when allocating marks. Increments of 0.5 can be allocated by the judge.

Excellent	10
Very Good	7.5-9.5
Satisfactory	5.0-7.0
Weak	2.5-4.5
Poor	0-2.0

Example: A Judge may choose to create times associated with "Recognition" to be consistent in their scoring across all teams.

Score Range	Seconds to recognition
10	0 - 20
7.5 – 9.5	21 - 40
5.0 – 7.0	41 - 60
2.5 – 4.5	61 - 90
0 – 2.0	90 - 120

## WET SERC

The aquatic Wet SERC may be conducted in indoor and outdoor swimming pool or open water aquatic environments. The event demonstrates how lifesavers work as a team in performing some or all of the skills associated with emergency response situations in an aquatic environment.

The four-person team are regarded as lifesavers who need to assess the situation and identify the condition of the victims and take appropriate action, including prioritisation of victims and appropriate rescue and treatment within a specified timeframe. This may include recruiting and directing bystanders to assist.

## WEIGHTING FACTOR

To recognize and acknowledge that some rescues require a greater degree of skill and judgment, a weighting factor or multiplier is applied to areas of the judge scoring sheets. Note: This enables a competitor to receive a higher score for the performance of rescues with a higher weighting factor linked to the priorities and principles of the rescue. These weighting factors are applied using an electronic recording spreadsheet and the calculations are reflected in the final score for the victim. The Judge gives a mark out of 10 for each performance criteria and the weighting factor accounts for the high, moderate, or low degree of difficulty.

A weighting factor matrix guide is outlined in the tables below to allow for the use of a range depending on the position and type of victim. The weighting factor is set by the scenario designer and approved by the Chief Referee based on the degree of difficulty in rescuing the victims. This allows flexibility between two similar victims with one being more difficult to rescue than the other.

## OVERVIEW OF WEIGHTING FACTOR FOR CHIEF JUDGE SCORE SHEET

<b>Performance Criteria ASSESSMENT</b>	<b>Weighting Factor/ Degree of Difficulty</b>
Significant barrier to assess and identify victim priorities (distance, obstacles, etc.)	1.5
Moderate barrier to assess and identify victim priorities (distance, obstacles, etc.)	1.25
Minor barrier to assess and identify victim priorities (distance, obstacles, etc.)	1
Rationale: The Team Leader needs to assess the victim priorities, redirect or dispatch rescuers as the priorities are identified or changed.	

<b>Performance Criteria CONTROL OVER THE SCENARIO</b>	<b>Weighting Factor/ Degree of Difficulty</b>
Significant limitations that provide difficulty for teams to maintain safety (lack of safety equipment, dangers, etc.)	1.5
Moderate environment, equipment, condition limitations to maintain safety (lack of safety equipment, dangers, etc.)	1.25
Minor environment, equipment, condition limitations to maintain safety (lack of safety equipment, dangers, etc.)	1
Rationale: Control over the scenario is essential, monitoring safety and environmental conditions, approaches may need to be adjusted to ensure the lowest risk to the rescuers.	

<b>Performance Criteria COMMUNICATION</b>	<b>Weighting Factor/ Degree of Difficulty</b>
Significant interference to communication due to size and layout or dimension of the area, noise, etc.	1.5
Moderate interference to communication due to size and layout or dimension of the area, noise, etc.	1.25

Minor interference to communication due to size and layout or dimension of the area, noise, etc.	1
Rationale: Interferences in communication due to size and layout or dimension of the area may require adjustments to the methods of communication to be effective.	

<b>Performance Criteria SEARCH</b>	<b>Weighting Factor/ Degree of Difficulty</b>
Victim is significantly hidden from view and searching	1.5
Victim is moderately hidden from view or searching	1.25
Victim is minimally hidden from view or searching	1
Rationale: Locating victims can be a challenge if the victims are hidden from view and/or obscured by equipment or other victims. This criterion reflects the difficulty associated with searching victims in these circumstances.	

<b>Performance Criteria TEAMWORK</b>	<b>Weighting Factor/ Degree of Difficulty</b>
Teamwork without bystanders/victim assistance or bystanders are uncooperative/distracting	1.5
Teamwork with reluctant bystanders/victim assistance	1.25
Teamwork with cooperative bystander/victim assistance	1
Rationale: Teamwork is improved when bystanders/victims are cooperative and available noting that clear and concise instructions need to be given. Teams need to listen and respond effectively when working as a team.	

<b>Performance Criteria VICTIM RECOGNITION, APPROACH</b>	<b>Weighting Factor/ Degree of Difficulty</b>
Victim far from landing i.e. 15 m+	1.5
Victim near to landing i.e. 6-10 m	1.25
Victim close to landing or on deck i.e. 5 m	1
Rationale: It is more difficult to recognize victims that are further away from the deck/dock or entry / exit point, and it takes more time to rescue them. Therefore, victims that are at a greater distance would receive a higher weighting factor.	

<b>Performance Criteria RESCUE</b>	<b>Weighting Factor/ Degree of Difficulty</b>
Refuses aid and will not swim in unless clear and concise directions are given	1.5
Accepts aid but will not swim in unless clear and concise directions are given	1.25
Accepts aid and swims in	1
Rationale: Victims are more difficult to rescue due to refusal or inability to hold an aid or swim to safety. Therefore, a higher weighting factor is allocated for victims that are more difficult to rescue or are uncooperative and the rescuer is rewarded for persistence and securing them. Mobilize the mobile, secure those in imminent danger and recover and resuscitate.	

<b>Performance Criteria</b> <b>CONTROL OF VICTIM</b>	<b>Weighting Factor/ Degree of Difficulty</b>
Talk or Throw rescue expected	1.5
Reach or Tow rescue expected	1.25
Carry rescue expected	1
Rationale: Rescuers should rescue those that have the highest chance of survival first and present the lowest risk of danger to the rescuer. Mobilize the mobile, secure those in imminent danger and recover and resuscitate. Therefore, victims that can be rescued easily should be rescued first and the more difficult victims rescued last.	

<b>Performance Criteria</b> <b>LANDING</b>	<b>Weighting Factor/ Degree of Difficulty</b>
Weak Swimmer/Mobile at time of landing	1.5
Non/Injured Swimmer at time of landing	1.25
Unconscious/Non breathing/Spinal Injured Swimmer at time of landing	1
Rationale: Rescuers should assist those who can help themselves or who could help others first to land then help those that require more effort and attention such as those who are in imminent danger like non swimmers, injured swimmers, and then finally those victims that require continuous care and resuscitation.	

<b>Performance Criteria</b> <b>CARE AND AFTERCARE OF VICTIM</b>	<b>Weighting Factor/ Degree of Difficulty</b>
Unconscious/Non breathing/Spinal Injured Swimmer	1.5
Non/Injured Swimmer	1.25
Weak Swimmer/Mobile	1
Rationale: Care and aftercare for victims that require continuous care or resuscitation is more difficult than those in imminent danger or who are weak or mobile. Therefore, a higher factor is assessed for victims that are more difficult to provide aftercare and monitoring.	

## **SAMPLE SCENARIO DESIGN WITH WEIGHTING FACTORS**

### **Scenario Description:**

You are at the sea on a pier; you observe several people who are on the pier and in the water following an explosion on a ferry which sinks in the harbor. The craft is overturned.

The only access to the sea is the designated area of the pier (side of the pool deck) to enter and exit the water. The ends of the pool and other side of the pool do not exist and are out of bounds.

### **Victims:**

Victim 1 – Weak swimmer wearing backpack/jug of water  
Victim 2 – Weak swimmer holding sport bag/rope

Victim 3 – Non swimmer

Victim 4 – Non swimmer

Victim 5 – Injured swimmer with burns on face and hands

Victim 6 – Injured swimmer with broken leg

Victim 7 – Injured swimmer with cervical spinal injury holding a floating ring

Victim 8 – Non breathing submerged manikin

Victim 9 – Non breathing, submerged manikin

<b>Victim # / Weighting Factor</b>	<b>Victim Recognition</b>	<b>Rescue</b>	<b>Control of Victim</b>	<b>Landing</b>	<b>Care and Aftercare of Victim</b>
<b>1</b>	1.25	1.5	1.5	1.5	1.0
<b>2</b>	1.25	1.5	1.5	1.5	1.0
<b>3</b>	1.25	1.25	1.25	1.25	1.25
<b>4</b>	1.25	1.25	1.25	1.25	1.25
<b>5</b>	1.5	1.25	1.25	1.25	1.25
<b>6</b>	1.5	1.25	1.25	1.25	1.25
<b>7</b>	1.0	1.25	1.0	1.25	1.5
<b>8</b>	1.0	1.0	1.0	1.0	1.5
<b>9</b>	1.5	1.0	1.0	1.0	1.5

### Judge Scoring Sheets

The judge scoring sheets provide for the victim types you may see in a SERC and how it will be scored. The sheets are made up of four key areas:

- Victim notes – includes general notes for the judge to direct the victim on how that type of victim might act or respond.
- Judge's notes – includes general notes for the judge on the type of victim and helpful hints on how the victim should act or will respond including how they should be rescued or secured to achieve high marks.
- Judge scoring sheet – separated into five different sections with key criteria the judge will be looking for.
- Marking scale – summarizes the ranking scale.

The scenario and associated score sheets are an example only.

**SAMPLE POOL SETUP, EQUIPMENT AND VICTIMS**

**Equipment and Victims – Each zone:** (1X) craft, (1X) paddle, (1X) lifejacket, (1X) spinal board, (1X) sport bag/rope, (1) backpack/jug of water, (1X) floating ring (2X) manikins, (7X) victims

**Scenario**

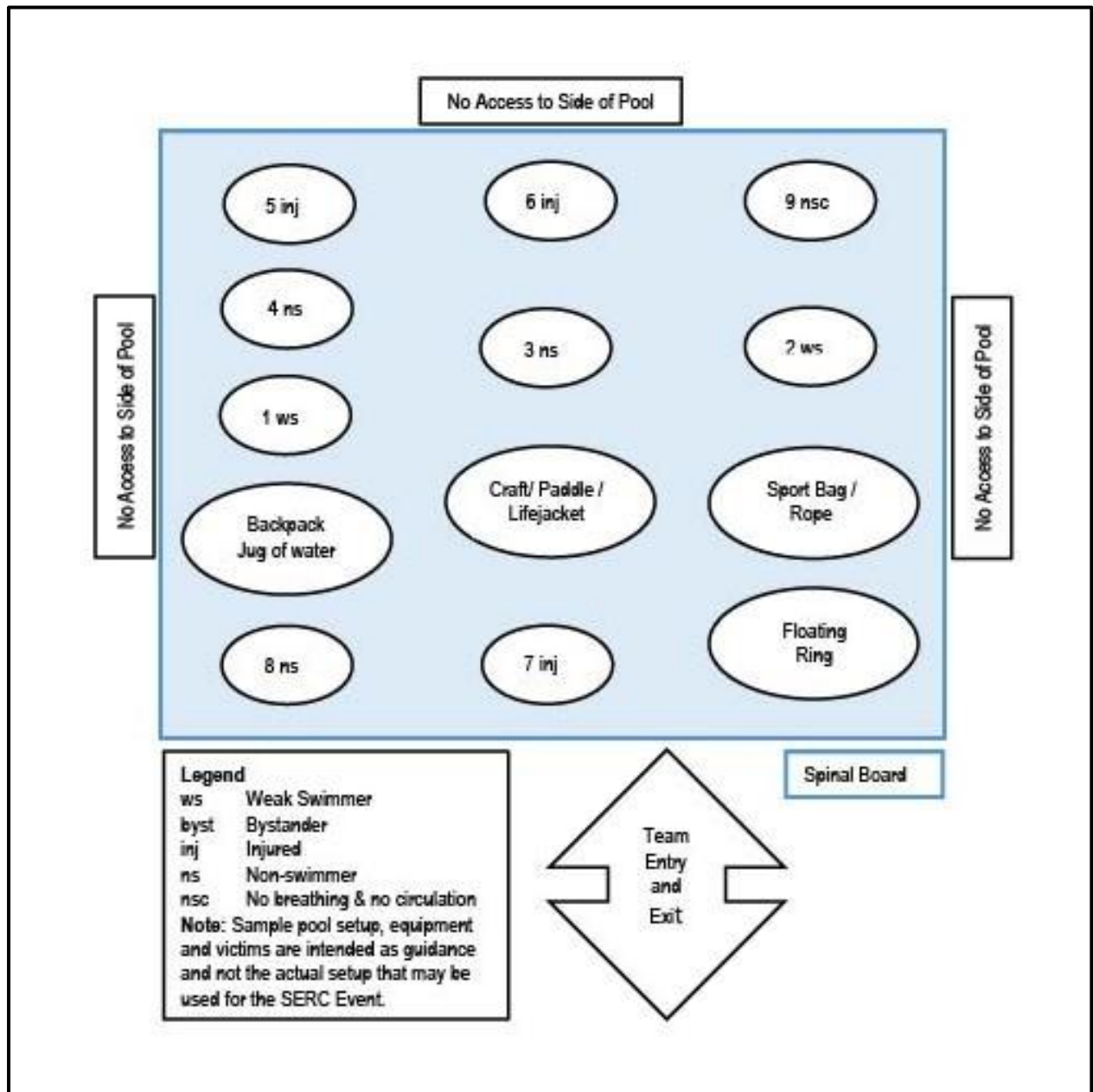

**FIGURE 36: SAMPLe POOL SETUP, EQUIPMENT AND VICTIMS**

## SAMPLE WET SERC JUDGING SHEETS

### OVERALL: SAMPLE CHIEF JUDGE SCORING SHEET

Draw No: \_\_\_\_\_ Team Name: \_\_\_\_\_ Judge Identification: \_\_\_\_\_

**Judges' notes:** Chief judge has the overview of the SERC area and assess overall efficiency of the team. In particular marks the Team Leader's control of the team – assessment of priorities and dispatch/direction of team members to deal with the victims. They will also mark communication between the Leader and the team and between team members and this may include information about the condition of the victims and what help is needed.

The marks **MUST** consider:

- Any loss of control by the Leader becoming committed or involved to such an extent that overall control is lost.
- Whether assistance was sought. Any person sent for help will not be allowed to return.
- **Do not mark any rescues the leader carries out as another judge is allocated to that victim.**

Areas of marking	Mark (10)					
<b>Assessment</b> Assessment of the emergency Did the Leader coordinate the team and direct to the correct priorities of rescue? On-going assessment / re-assessment						
<b>Control</b> Control and safety over the scenario area Leader retains control throughout the scenario On-going assessment / re-assessment						
<b>Communication</b> Communication and feedback between Leader and team members, and between team members and victims  Basic questioning and simple instructions given to victims and team Note: Emphasis is on non-verbal and simple verbal communication and not on extensive verbal communication.						
<b>Search</b> Effective search of scenario area Identification and location of victims						
<b>Teamwork</b> Teamwork, summon assistance (emergency services called) with appropriate information provided Identification and securing of all victims Effective use of bystanders / victims						
Unsafe actions by the Leader – <b>Deduct 10 points per occurrence</b> This includes rough handling of any victims						
<b>Total</b>						
<table border="1" style="width: 100%; border-collapse: collapse;"> <tr> <td style="width: 20%;">Excellent 10</td> <td style="width: 20%;">Very Good 7.5 – 9.5</td> <td style="width: 20%;">Satisfactory 5.0 – 7.0</td> <td style="width: 20%;">Weak 2.5 – 4.5</td> <td style="width: 20%;">Poor 0 – 2.0</td> </tr> </table>	Excellent 10	Very Good 7.5 – 9.5	Satisfactory 5.0 – 7.0	Weak 2.5 – 4.5	Poor 0 – 2.0	
Excellent 10	Very Good 7.5 – 9.5	Satisfactory 5.0 – 7.0	Weak 2.5 – 4.5	Poor 0 – 2.0		
Specific aspects of the scenario may be weighted to provide higher scores for a rescue performance requiring a greater degree of skill and judgment. Marking in increments of 0.5 allotted by the judge.						

**NON-SWIMMER: SAMPLE JUDGE SCORING SHEET**

Draw No: \_\_\_\_\_ Team Name: \_\_\_\_\_ Judge Identification: \_\_\_\_\_

**Victim: non-swimmer**

Describe the nature of the alleged victim and that they will likely panic as they cannot get to safety. Include if they can take a rescue aid if pushed into their reach and what they will do if a contact rescue is attempted, e.g. they will struggle and try to grab hold of the rescuer (they will not turn on their back). They will usually need assistance to get out of the water and when out will be exhausted from the experience.

**Judges' notes**

Non-swimmer is in imminent danger and is a high priority for rescue. They will attempt to grab any rescuer who approaches them directly without an aid. A reach or tow rescue is expected. Lower marks will be given if a contact rescue is used. The victim should be made safe with an effective and efficient return to safety. Landing should be done with care. They will answer questions asked of them.

Areas of marking	Mark (10)					
<b>Victim recognition/approach</b> Recognition of non-swimmer (high priority), speed of reaching victim Safe approach by rescuer						
<b>Rescue</b> Rescue with extreme caution (maximum 5 marks for this section if contact rescue used) Monitor while still in water; may require further directions/instructions						
<b>Control of victim</b> Clear effective questioning and reassurance Reassurance during rescue until returned to safety						
<b>Landing</b> Care of the victim; protection of the head Appropriate landing for size and strength of rescuer						
<b>Care and aftercare of victim</b> Safe position away from the edge; warmth and protection where possible; monitor safety; ongoing reassurance						
<b>Unsafe actions by the Rescuer – Deduct 10 points per occurrence</b> This includes rough handling of any victims						
<b>Total</b>						
<table border="1" style="width: 100%; border-collapse: collapse;"> <tr> <td style="width: 20%;">Excellent 10</td> <td style="width: 20%;">Very Good 7.5 – 9.5</td> <td style="width: 20%;">Satisfactory 5.0 – 7.0</td> <td style="width: 20%;">Weak 2.5 – 4.5</td> <td style="width: 20%;">Poor 0 – 2.0</td> </tr> </table>	Excellent 10	Very Good 7.5 – 9.5	Satisfactory 5.0 – 7.0	Weak 2.5 – 4.5	Poor 0 – 2.0	
Excellent 10	Very Good 7.5 – 9.5	Satisfactory 5.0 – 7.0	Weak 2.5 – 4.5	Poor 0 – 2.0		
Specific aspects of the scenario may be weighted to provide higher scores for a rescue performance requiring a greater degree of skill and judgment. Marking in increments of 0.5 allotted by the judge.						

**WEAK SWIMMER: SAMPLE JUDGE SCORING SHEET**

Draw No: \_\_\_\_\_ Team Name: \_\_\_\_\_ Judge Identification: \_\_\_\_\_

**Victim: weak swimmer**

Describe the nature of the alleged victim and that they will likely be struggling to get back to safety. Include if they are capable of shouting or calling out for help and whether they will be able to take an aid to get to safety. Include how they will respond if a contact rescue is performed, e.g. will they struggle and resist and can they land themselves and provide assistance or contact emergency services, are they cooperative.

**Judges' notes**

Weak swimmers need to be made safe very quickly. The victim can be talked at or given signs to return to safety; they will need to be kept monitored. They will struggle if a contact rescue is used; low marks should be awarded for contact rescue – a non-contact rescue such as talk or a throw rescue is expected. It is expected that the victim can remove themselves from the water with directions and higher marks will be given.

Areas of marking	Mark (10)			
<b>Victim recognition/approach</b> Recognition that they are a weak swimmer and high priority to mobilize. Safe approach by rescuer				
<b>Rescue</b> Encourage return to safety with clear directions; perform a non-contact rescue ( <b>maximum of 5 marks</b> if a contact rescue is used) Monitor while still in water; may require further directions/instructions				
<b>Control and use of victim</b> Effective communication / instruction; use for keeping another victim warm / safe				
<b>Landing</b> Make secure and land Appropriate landing for size and strength of rescuer				
<b>Care and aftercare of victim</b> Safe position away from danger; warmth and protection where possible; monitor safety; ongoing monitoring and care				
<b>Unsafe actions by the Rescuer – Deduct 10 points per occurrence</b> This includes rough handling of any victims				
<b>Total</b>				
Excellent 10	Very Good 7.5 – 9.5	Satisfactory 5.0 – 7.0	Weak 2.5 – 4.5	Poor 0 – 2.0
Specific aspects of the scenario may be weighted to provide higher scores for a rescue performance requiring a greater degree of skill and judgment. Marking in increments of 0.5 allotted by the judge.				

**NON-BREATHING VICTIM: SAMPLE JUDGE SCORING SHEET**

Draw No: \_\_\_\_\_ Team Name: \_\_\_\_\_ Judge Identification: \_\_\_\_\_

**Victim: unconscious, not breathing**

Describe the location of the victim e.g. on the bottom of the pool

**Judges' notes**

CPR should be commenced when it is safe to do so; on land, boat, rescue breaths with a buoyant aid in the water, etc. and your marks should reflect the efficiency and effectiveness of the CPR simulation (and not measured against your own Country/Nation's teaching / standards). A two-person removal is expected and will receive higher marks.

Areas of Marking	Mark (10)
<b>Victim Recognition/Approach</b> Identification of casualty	
<b>Rescue</b> Speed of rescue (considering priority of rescue) Speed in getting back to safety	
<b>Control of victim</b> Effective and efficient carry	
<b>Landing</b> Careful handling/landing of the casualty Higher marks are awarded for a two-person removal	
<b>Care and aftercare of victim</b> Effective and efficient CPR likely to assist recovery Safe position away from danger; monitor safety; ongoing monitoring and care	
Unsafe actions by the Rescuer – <b>Deduct 10 points per occurrence</b> This includes rough handling of any victims	
<b>Total</b>	
Excellent 10	Very Good 7.5 – 9.5
Satisfactory 5.0 – 7.0	Weak 2.5 – 4.5
	Poor 0 – 2.0
Specific aspects of the scenario may be weighted to provide higher scores for a rescue performance requiring a greater degree of skill and judgment. Marking in increments of 0.5 allotted by the judge.	

**INJURED VICTIM: SAMPLE JUDGE SCORING SHEET**

Draw No: \_\_\_\_\_ Team Name: \_\_\_\_\_ Judge Identification: \_\_\_\_\_

**Victim: conscious victim with injury**

Describe the nature of the injury

**Judges' notes**

A Reach or Tow rescue is expected; Rescuer should use an aid, and lower marks will be awarded if a contact rescue is used). Victim may not be able to hold an aid depending on the injury and may need assistance in the water and on landing. The victim should be removed carefully from the water with attention to the injured part of the body. They will not be cooperative.

Areas of Marking	Mark (10)					
<b>Victim recognition/approach</b> Recognition that they are an injured swimmer and medium priority to mobilize Safe approach by rescuer						
<b>Rescue</b> Encourage to return to the edge with clear directions Perform non-contact rescue <b>(maximum of 5 marks if a contact rescue is used)</b> Monitor while still in water; may require further directions/instructions						
<b>Control of victim</b> Effective communication / instruction Reassurance throughout rescue						
<b>Landing</b> Careful removal from water with attention to injury Make secure and land (monitor while still in water; may require further directions/instructions) Appropriate landing for size and strength of rescuer						
<b>Care and aftercare of victim</b> Safe position away from the edge; warmth and protection where possible; monitor safety; ongoing monitoring and care						
<b>Unsafe actions by the Rescuer – Deduct 10 points per occurrence</b> This includes rough handling of any victims						
<b>Total</b>						
<table border="1" style="width: 100%; border-collapse: collapse;"> <tr> <td style="width: 20%;">Excellent 10</td> <td style="width: 20%;">Very Good 7.5 – 9.5</td> <td style="width: 20%;">Satisfactory 5.0 – 7.0</td> <td style="width: 20%;">Weak 2.5 – 4.5</td> <td style="width: 20%;">Poor 0 – 2.0</td> </tr> </table>	Excellent 10	Very Good 7.5 – 9.5	Satisfactory 5.0 – 7.0	Weak 2.5 – 4.5	Poor 0 – 2.0	
Excellent 10	Very Good 7.5 – 9.5	Satisfactory 5.0 – 7.0	Weak 2.5 – 4.5	Poor 0 – 2.0		
Specific aspects of the scenario may be weighted to provide higher scores for a rescue performance requiring a greater degree of skill and judgment. Marking in increments of 0.5 allotted by the judge.						

**BYSTANDER: SAMPLE JUDGE SCORING SHEET**

Draw No: \_\_\_\_\_ Team Name: \_\_\_\_\_ Judge Identification: \_\_\_\_\_

**Victim: conscious victim with injury**

Describe whether the bystander can offer assistance, whether they will be cooperative and take direction and what if anything they are doing in the scenario, e.g. teaching a class

**Judges' notes**

This is a high priority bystander as they can lend assistance when given direction. The Bystander will not be permitted to return if they are sent for assistance outside the entry/exit zone

Areas of Marking	Mark (10)					
<b>Victim recognition/approach</b> Recognition that they are a bystander and whether they can assist						
<b>Assesses relevant information</b> Questions bystander to assess information about the scenario. (maximum of 5 marks if clear directions are not given to the bystander)						
<b>Provides direction and instructions</b> Rescuer provides directions or instructions to assist the rescue scenario such as assist with removals, reassure victims, call emergency services.						
<b>Monitoring bystander actions</b> Check periodically to ensure that bystander has followed the directions of the Rescuer throughout rescue						
<b>Provides ongoing encouragement</b> Provides feedback to bystander on their actions to encourage them to assist with victim support						
<b>Unsafe actions by the Rescuer – Deduct 10 points per occurrence</b> This includes rough handling of any victims						
<b>Total</b>						
<table border="1" style="width: 100%; border-collapse: collapse;"> <tr> <td style="width: 20%;">Excellent 10</td> <td style="width: 20%;">Very Good 7.5 – 9.5</td> <td style="width: 20%;">Satisfactory 5.0 – 7.0</td> <td style="width: 20%;">Weak 2.5 – 4.5</td> <td style="width: 20%;">Poor 0 – 2.0</td> </tr> </table>	Excellent 10	Very Good 7.5 – 9.5	Satisfactory 5.0 – 7.0	Weak 2.5 – 4.5	Poor 0 – 2.0	
Excellent 10	Very Good 7.5 – 9.5	Satisfactory 5.0 – 7.0	Weak 2.5 – 4.5	Poor 0 – 2.0		
Specific aspects of the scenario may be weighted to provide higher scores for a rescue performance requiring a greater degree of skill and judgment. Marking in increments of 0.5 allotted by the judge.						

## DRY SERC

The Dry SERC is not an aquatic event, it is a dry land simulated emergency response/first aid competition, however, the event may be conducted within an area with water. It is conducted as a two-person team responding to an unknown simulated emergency response, involving between 2 to 4 victims based on basic lifesaving training.

The two-person team are regarded as volunteer lifesavers who need to assess the situation and identify the condition of the victims and take appropriate action, including prioritisation of victims and appropriate treatment within a specified timeframe. This may include recruiting and directing bystanders.

## VICTIM MEDICAL CONDITIONS

Victims will be selected by the scenario designer and approved by the Chief Referee from the following list:

- Cardiac event / Non breathing
- Bleeding
- Embedded object
- Fracture
- Sprain/strain
- Seizure
- Environmental – hot or cold emergency

## SCENARIO DESIGN

The Dry SERC design is a scenario which explains the victims' conditions. The design should be straight forward yet challenging and as realistic as possible.

Once the scenario is designed, it is the judge's responsibility to ensure that the victim can simulate the condition safely and consistently for all teams.

## WEIGHTING FACTORS

Weighting Factors may be used in this event depending on the nature of the scenario and the treatment required. The judges score will reflect the performance of the lifesaver based on the efficiency and quality of their treatment, their ability to manage the scene, and their ability to work as a team.

## TREATMENT

The expected treatments are based on minimum requirements understood to be consistent worldwide.

## EQUIPMENT

A first aid kit should include the following contents:

- Pocket Masks - 2
- Disposable gloves – 6 pairs
- gauze pads (7.5 cm) – 4
- Roll gauze - 4
- Triangular bandages - 4
- Compression bandage 1
- Ring Bandage - 1
- Set of Splints – 1 set
- Instant Cold Pack - 1
- Instant Hot Pack - 1
- Sterile water bottle - 2
- Blankets – 2

**SAMPLE DRY SERC JUDGING SHEETS****CARDIAC EVENT / NON BREATHING VICTIM: SAMPLE JUDGE SCORING SHEET**

Draw No: \_\_\_\_\_ Team Name: \_\_\_\_\_ Judge Identification: \_\_\_\_\_

**Victim:** non breathing.

Specific scenario notes will be included

**Judges' notes**

Alerting emergency services may be done out of sequence. The current ratios for CPR are 30 compressions to 2 breaths.

Where CPR is required to be performed a manikin will be used, this may include swapping a victim for a manikin during the scenario.

Areas of Marking	Mark (10)					
<b>Victim recognition/approach</b> Recognition that they are in distress / need of immediate assistance Safe approach by lifesaver Ensures safety of lifesaver and victim – assessing dangers Correct use of personal protective equipment – mask, gloves						
<b>Assessment</b> Request assistance from bystander to understand what has happened, information about the victim and their history Check for response / Send for help Check the mouth and throat are clear Open airway [e.g. using a head tilt and chin lift] Assess for breathing – for at least 10 seconds						
<b>Treatment</b> Effective CPR –head tilt/chin lift or modified jaw thrust; seal of mouth/nose/mask Correct: hand position, rate, ratio, compression depth, compression arm kept straight, 30:2 cycle with compressions before breaths Breaths – effective seal [mouth or nose], no over inflation; watch for rise and fall of the chest Correct use of personal protective equipment – mask, gloves						
<b>Care and aftercare of victim</b> Safe position away from any danger; ongoing treatment, Monitoring of the victim and ongoing care Recruitment of bystanders / effective use of bystanders						
<b>Overall</b> Assessment and control of the scene Communications with victim, bystanders, other lifesavers– calm, effective, clear, etc. Emergency services contacted / use of appropriate equipment						
Unsafe actions by the Lifesaver – <b>Deduct 10 points per occurrence</b> This includes rough handling of any victims						
<b>Total</b>						
<table border="1" style="width: 100%; border-collapse: collapse;"> <tr> <td style="width: 20%;">Excellent 10</td> <td style="width: 20%;">Very Good 7.5 – 9.5</td> <td style="width: 20%;">Satisfactory 5.0 – 7.0</td> <td style="width: 20%;">Weak 2.5 – 4.5</td> <td style="width: 20%;">Poor 0 – 2.0</td> </tr> </table>	Excellent 10	Very Good 7.5 – 9.5	Satisfactory 5.0 – 7.0	Weak 2.5 – 4.5	Poor 0 – 2.0	
Excellent 10	Very Good 7.5 – 9.5	Satisfactory 5.0 – 7.0	Weak 2.5 – 4.5	Poor 0 – 2.0		
Marking in increments of 0.5 allotted by the judge.						

**BLEEDING: SAMPLE JUDGE SCORING SHEET**

Draw No: \_\_\_\_\_ Team Name: \_\_\_\_\_ Judge Identification: \_\_\_\_\_

**Victim: breathing**

Specific scenario notes will be included

**Judges' notes**

Alerting emergency services may be done out of sequence. Lifesavers should make the area safe prior to treatment

Areas of Marking	Mark (10)					
<b>Victim recognition/approach</b> Recognition that they are in distress / need of immediate assistance Safe approach by lifesaver; ensure safety of lifesaver and victim and others – assessing dangers Use of personal protective equipment – e.g. gloves						
<b>Assessment</b> Questions victim to assess information about the situation and their condition <ul style="list-style-type: none"> <li>- Check for response</li> <li>- What has happened? How are you feeling? Do you have any medical conditions?</li> <li>- Are you here with anyone? Solicits a response</li> <li>- Correct identification of the injury</li> </ul>						
<b>Treatment for Injury</b> Effective treatment to control bleeding – direct pressure, decreased movement by the victim [consider elevation] / apply pressure bandage Reassurance throughout Prevent further injury						
<b>Care and aftercare of victim</b> Safe position away from any danger; ongoing treatment, monitoring and care Monitor vital signs and treat for shock – maintain body temperature, monitor level of consciousness						
<b>Overall</b> Assessment and control of the scene Communications with victim, bystanders, other lifesavers– calm, effective, clear, etc. Use of resources – emergency services contacted Recruitment and effective use of bystanders						
Unsafe actions by the Lifesaver – <b>Deduct 10 points per occurrence</b> This includes rough handling of any victims						
<b>Total</b>						
<table border="1" style="width: 100%; border-collapse: collapse;"> <tr> <td style="width: 20%;">Excellent 10</td> <td style="width: 20%;">Very Good 7.5 – 9.5</td> <td style="width: 20%;">Satisfactory 5.0 – 7.0</td> <td style="width: 20%;">Weak 2.5 – 4.5</td> <td style="width: 20%;">Poor 0 – 2.0</td> </tr> </table>	Excellent 10	Very Good 7.5 – 9.5	Satisfactory 5.0 – 7.0	Weak 2.5 – 4.5	Poor 0 – 2.0	
Excellent 10	Very Good 7.5 – 9.5	Satisfactory 5.0 – 7.0	Weak 2.5 – 4.5	Poor 0 – 2.0		
Marking in increments of 0.5 allotted by the judge.						

**EMBEDDED OBJECT: SAMPLE JUDGE SCORING SHEET**

Draw No: \_\_\_\_\_ Team Name: \_\_\_\_\_ Judge Identification: \_\_\_\_\_

**Victim: is breathing with an embedded object in the arm / hand / leg or foot.****Judges' notes**

Alerting emergency services may be done out of sequence. Lifesavers should make the environment safe prior to treatment.

Areas of Marking	Mark (10)					
<b>Victim recognition/approach</b> Recognition that they are in distress / injured Safe approach by lifesaver; ensure safety of lifesaver and victim and others – assessing dangers Use of personal protective equipment – e.g. gloves						
<b>Assessment</b> Questions victim to assess information about situation <ul style="list-style-type: none"> <li>- Check for response</li> <li>- What has happened? How are you feeling? Do you have any medical conditions?</li> <li>- Are you here with anyone? Solicits a response</li> <li>- Correct identification of the injury</li> </ul> Contact emergency services						
<b>Treatment for Injury</b> Effective treatment for bleeding – direct pressure, decreased movement by the victim Application of a ring bandage or action to reduce the movement of the embedded object. Does not remove object; object is secured when bandaged Reassurance throughout						
<b>Care and aftercare of victim</b> Safe position away from any danger; ongoing treatment, monitoring and care Monitor vital signs and treat for shock – maintain body temperature, monitors level of consciousness						
<b>Overall</b> Assessment and control of the scene Communications with victim, bystanders, other lifesavers– calm, effective, clear, etc. Use of resources – emergency services contacted, use of equipment Recruitment and effective use of bystanders						
<b>Unsafe actions by the Lifesaver – Deduct 10 points per occurrence</b> This includes rough handling of any victims						
<b>Total</b>						
<table border="1" style="width: 100%; border-collapse: collapse;"> <tr> <td style="width: 20%;">Excellent 10</td> <td style="width: 20%;">Very Good 7.5 – 9.5</td> <td style="width: 20%;">Satisfactory 5.0 – 7.0</td> <td style="width: 20%;">Weak 2.5 – 4.5</td> <td style="width: 20%;">Poor 0 – 2.0</td> </tr> </table>	Excellent 10	Very Good 7.5 – 9.5	Satisfactory 5.0 – 7.0	Weak 2.5 – 4.5	Poor 0 – 2.0	
Excellent 10	Very Good 7.5 – 9.5	Satisfactory 5.0 – 7.0	Weak 2.5 – 4.5	Poor 0 – 2.0		
Marking in increments of 0.5 allotted by the judge.						

**FRACTURE: SAMPLE JUDGE SCORING SHEET**

Draw No: \_\_\_\_\_ Team Name: \_\_\_\_\_ Judge Identification: \_\_\_\_\_

**Victim: is breathing and has broken or fractured a bone****Judges' notes**

Alerting emergency services may be done out of sequence. Lifesavers should make the environment safe prior to treatment – i.e., moving the victim, sitting the victim down, etc.

Areas of Marking	Mark (10)					
<b>Victim recognition/approach</b> Recognition that they are in distress / injured Safe approach by lifesaver; ensure safety of lifesaver and victim and others – assessing dangers Use of personal protective equipment – e.g. gloves Ensures safety of lifesaver and victim						
<b>Assessment</b> Questions victim to assess information about situation - Check for response - What has happened? How are you feeling? Do you have any medical conditions? - Are you here with anyone? Solicits a response - Correct identification of the injury						
<b>Treatment for Injury</b> Effective immobilization and ice pack, consider using a splint Appropriate use of first aid equipment Reassurance throughout Prevents further injury – instructs victim to keep still and not apply weight/pressure to the injured area.						
<b>Care and aftercare of victim</b> Safe position away from any danger; ongoing treatment, monitoring, and care Monitor vital signs and treat for shock – maintain body temperature, monitor level of						
<b>Overall</b> Assessment and control of the scene Communications with victim, bystanders, other lifesavers– calm, effective, clear, etc. Use of resources – emergency services contacted, Recruitment and effective use of bystanders						
Unsafe actions by the Lifesaver – <b>Deduct 10 points per occurrence</b> This includes rough handling of any victims						
<b>Total</b>						
<table border="1" style="width: 100%; border-collapse: collapse;"> <tr> <td style="width: 20%;">Excellent 10</td> <td style="width: 20%;">Very Good 7.5 – 9.5</td> <td style="width: 20%;">Satisfactory 5.0 – 7.0</td> <td style="width: 20%;">Weak 2.5 – 4.5</td> <td style="width: 20%;">Poor 0 – 2.0</td> </tr> </table>	Excellent 10	Very Good 7.5 – 9.5	Satisfactory 5.0 – 7.0	Weak 2.5 – 4.5	Poor 0 – 2.0	
Excellent 10	Very Good 7.5 – 9.5	Satisfactory 5.0 – 7.0	Weak 2.5 – 4.5	Poor 0 – 2.0		
Marking in increments of 0.5 allotted by the judge.						





**ENVIRONMENTAL – COLD: SAMPLE JUDGE SCORING SHEET**

Draw No: \_\_\_\_\_ Team Name: \_\_\_\_\_ Judge Identification: \_\_\_\_\_

**Victim: breathing victim exposed to cold / hypothermia****Judges' notes**

Alerting emergency services may be done out of sequence. Lifesavers should make the environment safe prior to treatment – i.e., moving the victim, sitting the victim down, etc.

Areas of Marking	Mark (10)					
Victim recognition/approach Recognition that they are in distress Safe approach by lifesaver; ensure safety of lifesaver and victim and others – assessing dangers Use of personal protective equipment – e.g. gloves						
<b>Assessment</b> Questions victim to assess information about situation Check response <ul style="list-style-type: none"> <li>- What has happened? How are you feeling? Do you have any medical conditions?</li> <li>- Are you here with anyone? Solicits a response</li> <li>- Correct identification of the condition</li> </ul>						
<b>Treatment</b> Correct treatment and appropriate use of first aid equipment – warms body core; does not rub skin; removes wet clothing etc. Reassurance throughout Prevents further injury – removes victim to safe area, etc.						
<b>Care and aftercare of victim</b> Safe position away from any danger; ongoing treatment, monitoring and care Recruitment and effective use of bystanders Monitor vital signs and treats for shock – maintains body temperature, monitor level of consciousness						
<b>Overall</b> Assessment and control of the scene Communications with victim, bystanders, other lifesavers – calm, effective, clear, etc. Use of resources – emergency services contacted, use of equipment Recruitment and effective use of bystanders						
Unsafe actions by the Lifesaver – <b>Deduct 10 points per occurrence</b> This includes rough handling of any victims						
<b>Total</b>						
<table border="1" style="width: 100%; border-collapse: collapse;"> <tr> <td style="width: 20%;">Excellent 10</td> <td style="width: 20%;">Very Good 7.5 – 9.5</td> <td style="width: 20%;">Satisfactory 5.0 – 7.0</td> <td style="width: 20%;">Weak 2.5 – 4.5</td> <td style="width: 20%;">Poor 0 – 2.0</td> </tr> </table>	Excellent 10	Very Good 7.5 – 9.5	Satisfactory 5.0 – 7.0	Weak 2.5 – 4.5	Poor 0 – 2.0	
Excellent 10	Very Good 7.5 – 9.5	Satisfactory 5.0 – 7.0	Weak 2.5 – 4.5	Poor 0 – 2.0		
Marking in increments of 0.5 allotted by the judge.						

**ENVIRONMENTAL – HOT: SAMPLE JUDGE SCORING SHEET**

Draw No: \_\_\_\_\_ Team Name: \_\_\_\_\_ Judge Identification: \_\_\_\_\_

**Victim is suffering from heat exhaustion****Judges' notes**

Alerting emergency services may be done out of sequence. Lifesavers should make the environment safe prior to treatment – i.e., moving the victim from the heat, sitting the victim down, etc.

Areas of Marking	Mark (10)					
<b>Victim recognition/approach</b> Recognition that they are in distress Safe approach by lifesaver; ensure safety of lifesaver and victim and others – assessing dangers Use of personal protective equipment – e.g. gloves						
<b>Assessment</b> Questions victim to assess information about situation <ul style="list-style-type: none"> <li>- Check response</li> <li>- What has happened? How are you feeling? Do you have any medical conditions?</li> <li>- Are you here with anyone? Solicits a response</li> <li>- Correct identification of the condition</li> </ul>						
<b>Treatment</b> Appropriate use of first aid equipment and correct treatment – cools victim, removes from sun, provides water or sports drink [small amounts]; treat for shock Reassurance throughout Prevents further injury – removes victim to safe area, instructs victim to sip fluids, etc.						
<b>Care and aftercare of victim</b> Safe position away from any danger; ongoing treatment, monitoring and care Recruitment and effective use of bystanders Monitor vital signs and treat for shock – maintain body temperature, monitor level of consciousness						
<b>Overall</b> Assessment and control of the scene Communications with victim, bystanders, other lifesavers – calm, effective, clear, etc. Use of resources – emergency services contacted Recruitment and effective use of bystanders						
<b>Unsafe actions by the Lifesaver – Deduct 10 points per occurrence</b> This includes rough handling of any victims.						
<b>Total</b>						
<table border="1" style="width: 100%; border-collapse: collapse;"> <tr> <td style="width: 20%;">Excellent 10</td> <td style="width: 20%;">Very Good 7.5 – 9.5</td> <td style="width: 20%;">Satisfactory 5.0 – 7.0</td> <td style="width: 20%;">Weak 2.5 – 4.5</td> <td style="width: 20%;">Poor 0 – 2.0</td> </tr> </table>	Excellent 10	Very Good 7.5 – 9.5	Satisfactory 5.0 – 7.0	Weak 2.5 – 4.5	Poor 0 – 2.0	
Excellent 10	Very Good 7.5 – 9.5	Satisfactory 5.0 – 7.0	Weak 2.5 – 4.5	Poor 0 – 2.0		
Marking in increments of 0.5 allotted by the judge.						

**BYSTANDER: SAMPLE JUDGE SCORING SHEET**

Draw No: \_\_\_\_\_ Team Name: \_\_\_\_\_ Judge Identification: \_\_\_\_\_

**Victim: is a bystander and not in immediate danger****Judges' notes**

The Bystander will not be permitted to return if they are sent for assistance outside the entry/exit zone.

Areas of Marking	Mark (10)					
<b>Victim recognition/approach</b> Recognition that they are a bystander and cooperative. Safe approach by lifesaver; ensure safety of lifesaver and victim and others – assessing dangers						
<b>Assesses relevant information</b> Questions bystander to assess information about the scenario. (maximum of 5 marks if clear directions are not given to the bystander)						
<b>Provides direction and instructions</b> Rescuer provides directions or instructions to assist the first aid scenario such as assist with movement of a victim, reassure victims, call emergency services.						
<b>Monitoring bystander actions</b> Check periodically to ensure that bystander has followed the directions of the Lifesaver throughout						
<b>Provides ongoing encouragement</b> Provides feedback to bystander on their actions to encourage them to assist with victim support						
<b>Unsafe actions by the Lifesaver – Deduct 10 points per occurrence</b> This includes rough handling of any victims						
<b>Total</b>						
<table border="1" style="width: 100%; border-collapse: collapse;"> <tr> <td style="width: 20%;">Excellent 10</td> <td style="width: 20%;">Very Good 7.5 – 9.5</td> <td style="width: 20%;">Satisfactory 5.0 – 7.0</td> <td style="width: 20%;">Weak 2.5 – 4.5</td> <td style="width: 20%;">Poor 0 – 2.0</td> </tr> </table>		Excellent 10	Very Good 7.5 – 9.5	Satisfactory 5.0 – 7.0	Weak 2.5 – 4.5	Poor 0 – 2.0
Excellent 10	Very Good 7.5 – 9.5	Satisfactory 5.0 – 7.0	Weak 2.5 – 4.5	Poor 0 – 2.0		
Marking in increments of 0.5 allotted by the judge.						



**World Water Safety**  
**INTERNATIONAL LIFE SAVING FEDERATION**

## **ILS COMPETITION RULE BOOK**

### **SECTION 6** **SURF BOAT EVENTS**



**2025 EDITION**  
**(Revised May 2026)**

## SECTION 6 SURFBOAT COMPETITION

### 1. GENERAL CONDITIONS FOR SURF BOAT COMPETITION

Team management and competitors are responsible for being familiar with the competition schedule, and with the rules and procedures governing surf boat events.

- A. A surf boat is an oared craft used by a crew consisting of five competitors, four of whom shall be Rowers and the fifth who shall control the boat by a Sweep oar and shall be known as the Sweep oarsman or Sweep. A crew must commence each race with all five competitors.

**Note:** Refer to the ILS specifications for surfboat details.

The Sweep: With the approval of the Organising Committee, proficient Sweeps who are non-team members may function as Sweeps for clubs from national lifesaving organisations which are developing surf boat racing, provided the Sweeps are members of a current ILS Full Member Organisation, and are registered in the competition in some capacity.

Surf Boat competition shall be conducted in both male and female categories. Crews are permitted to compete in more than one category, with the following exceptions:

- No crew or individual may compete in both Open and Reserve Grade categories.
  - 19 Years or 23 Years crews or individuals may compete in their age category and either Open or Reserve Grade, but not both.
  - Sweeps may participate in any category as a Sweep, including Male and Female categories, irrespective of their gender and age. However, with the exception of the Note: “The Sweep” (above) may only compete in a category once, irrespective of whether they are Sweeping or rowing.
  - Sweeps may compete in multiple Masters total-age groups as a Sweep, but shall only compete in a particular category once, irrespective of whether they are Sweeping or rowing.
  - The Masters Surf Boat Race shall be conducted in both male and female categories in eight total-age groups: 120 years or more; 140 years or more; 160 years or more; 180 years or more; 200 years or more; 220 years or more; 240 years or more; and 260 years or more. The age group is calculated using the total of the ages of the four rowers in the crew and does not include the Sweep.
  - A Masters competitor may only compete in one Masters age group as a rower but may also compete in multiple Masters age groups as the Sweep.
  - The Sweep need not be a Masters competitor but must be proficient as a Sweep. The Sweep is considered to be gender neutral with respect to participation in male and female events.
  - Masters’ competitors are permitted to compete as a rower in one Masters age-group and in either Open or Reserve grade categories.
  - Should a member of any crew become indisposed, he or she may be replaced subject to approval of the Chief Referee, provided the competitor complies with the requirements for team substitution and any special entry conditions.
  - If 19 Years or 23 Years competitors are rowing in an older age category made up of mixed age-groups, they can continue to row in that older age category event if their own individual age division is suspended or cancelled. However, a crew made up entirely of rowers from suspended or cancelled age or gender group(s) shall not be permitted to compete.
- B. Crews may not be permitted to start in an event if they are late reporting to the Marshalling Area
- C. A crew absent from the start of an event shall be disqualified.
- D. Crew and Officials must leave the designated competition area when not competing or officiating.
- E. Unless specifically provided for, no artificial means of propulsion may be used in competition.
- F. Video cameras may be mounted on Surf Boats as long as such devices conform to the requirements specified in Section 8, Facility and Equipment Standards and Scrutineering Procedures. With the exception of the Sweep, video cameras may not be worn by competitors or otherwise attached to a competitor from start to finish of a race.
- The Sweep may wear a video camera on their helmet, provided that the camera is installed on a mounting device and toggle strap supplied or recommended by the manufacturer of the device.
- G. Boat crews shall be dressed in accordance with 2.10 Competition attire. However, the Sweep may wear different style apparel as warranted by the conditions. Crews may wear flotation vests.

- H. All boat rowers and Sweeps must wear an approved aquatic helmet (e.g., EN1385 certified or equivalent) during competition unless the Competition Committee or the Chief Referee has issued a dispensation because of favourable conditions.
- I. Should conditions alter during the course of an event, the Chief Referee may reverse the initial and subsequent decisions for the optional wearing of an approved aquatic helmet and mandate that all boat rowers and Sweeps must wear an approved aquatic helmet in competition.
- J. A decision to make wearing of an approved aquatic helmet optional is subject to a documented risk assessment that determines an acceptably low risk level.
- K. A nominal wave height of 1m is considered the maximum threshold where wearing of an approved aquatic helmet may be considered optional. Wave height is only one consideration in assessing surf zone hazards (examples of others could include: a heavy shore break, littoral drift, shorter wave periods, wind strength and direction). Helmets should be presented in team colours and design.
- L. All competitors from the same team shall wear their Official team helmets (or Official swim caps if wearing of an approved aquatic helmet is not required). Helmets/Caps must be securely fastened under the chin, at the start of a race.
- M. A team shall not be disqualified if the helmet or cap is displaced or lost after the start of an event provided that Officials could identify that the crew correctly completed the course.
- N. A Boat Rowers Panel of at least three qualified and experienced surf boat representatives shall be appointed to discuss boat rowing conditions with competition Officials and to represent competitors. The Organising Committee shall endorse the members of the Boat Rowers Panel for the competition. The Boat Rowers Panel shall act as a communication link between competitors and Officials and act under the following guidelines:
- The representatives of the Boat Rowers Panel shall liaise directly with the Chief Referee on all matters pertaining to the conduct of the competition.
  - The Boat Rowers Panel will assist in assessing hazards and provide advice to the Chief Referee regarding event-specific safety considerations including recommendations regarding the wearing of helmets for a competition in the event of acceptably low risk levels (see G. above).  
**Note:** Should conditions alter during the course of an event, the Chief Referee may reverse the initial decision for the optional wearing of approved aquatic helmets and mandate that all boat rowers and Sweeps must wear an approved aquatic helmet in competition. The decision of the Chief Referee is not subject to protest and or appeal.
  - The Boat Rowers Panel may assist the Chief Referee in setting competition courses prior to the commencement of competition.
  - Protests regarding surf boat competition shall be dealt with in accordance with the ILS Competition Rule Book and any subsequent bulletins and entry conditions.
  - The Boat Rowers Panel representatives shall abide by any decision of the Organising Committee, Chief Referee, and/or Appeals Committee.

### 1.1. Luck of prevailing conditions

No protest or appeal will be entertained when an incident is caused by the prevailing conditions (see S2-7 Luck of Prevailing Conditions).

### 1.2. Competition area

The competition area may be defined as the section of the beach encompassed by a line or fence, or a direct line to the water from the extreme ends of a line or fence or other designated areas as specified by the Chief Referee.

## 2. THE COURSE

The course shall be as detailed in the diagram.

The boat turning buoys and the gate buoys should be of distinctive colours.

The turning buoys should be set at a minimum of 350m rowing distance from the end of knee depth water at the low tide mark depending on prevailing surf conditions and should be set in such a position to allow the boats to clear other course buoys by taking a direct course to and from their respective turning buoys.

The turning buoys should be set so as to provide a course which is as fair as possible and which will give all crews the same distance to row, regardless of which position they are allocated.

The gate buoys, which are optional at the Chief Referee's discretion for usage on the return journey, should be:

- 
- Set in line with the turning buoys on the seaward side of the break area and inshore from the turning buoys.
  - Negotiated as directed by the Chief Referee or Sectional Referee.

The finishing line shall be a line of sight drawn between two orange and blue diagonal flags (or other colour(s) as determined by the Chief Referee) on poles positioned far enough apart to correspond with the number of buoys laid (see diagram) and to allow all boats to finish afloat.

In some circumstances a video finish line will be used. In these cases, the finish line will be the line of sight between the video cameras, but the competition area will still be marked by the flags or poles. The Chief Referee will inform competitors when the video is being used as the finish line.

As an alternative to the above, there is also an option for dry starts and finishes in any combination with wet starts and wet finishes.

Large, elevated boat position markers, in the corresponding boat buoy colours, may be positioned on the beach in each lane to assist Sweeps returning to the beach within their lane.

When it is not possible to provide a fair course over the full number of positions, the Chief Referee, at their discretion, may reduce the number of crews in each race, including the finals to improve the fairness of racing.

If it is clearly evident that the turning buoys are not parallel to the beach and therefore not fair for all crews, the buoys may be adjusted immediately at the discretion of the Chief Referee.

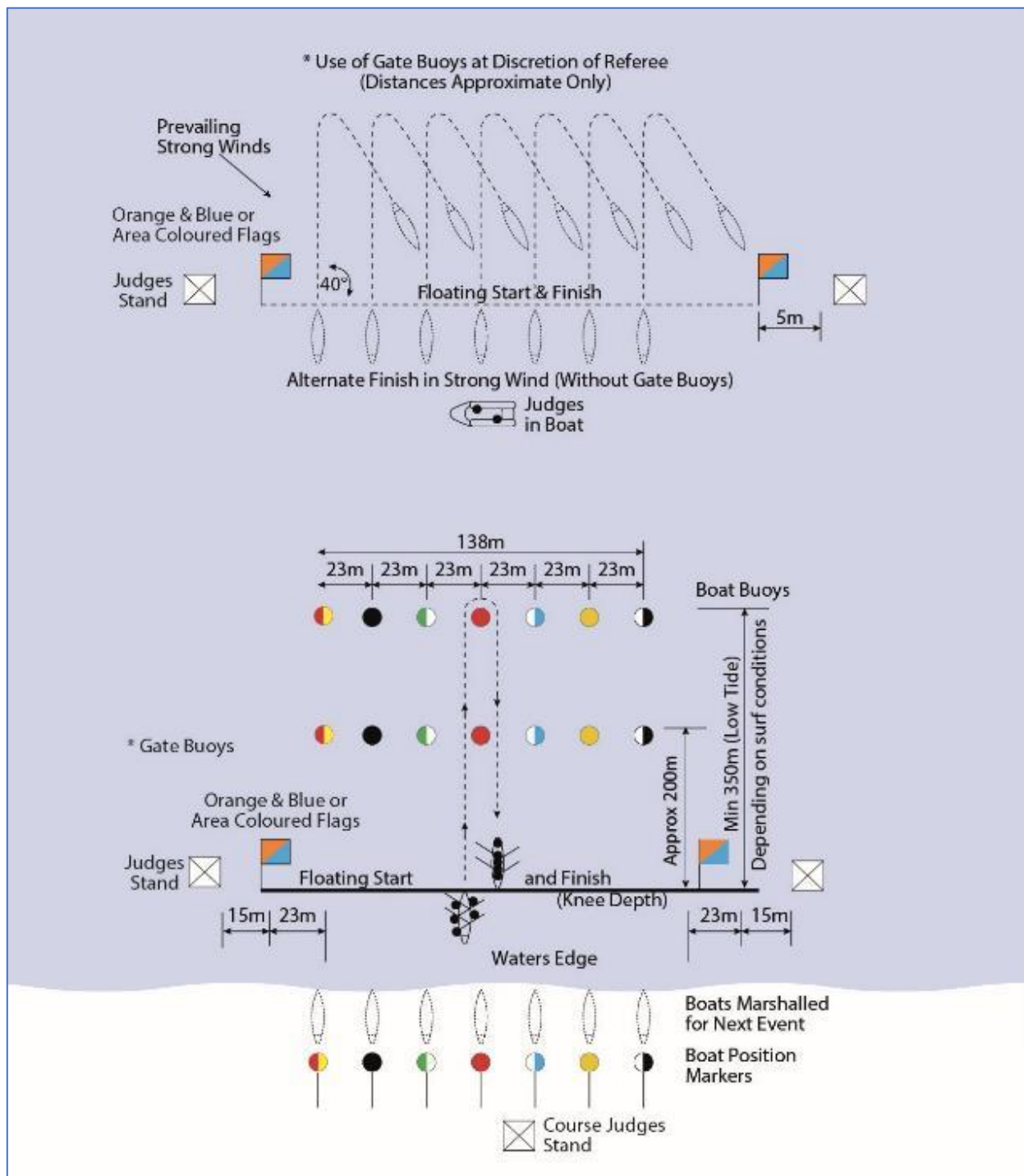

**FIGURE 37: SURF BOAT RACE**  
 (Distances approximate only)

**Note 1:** The layout of the Competition Arena, including the beach setup relative to the positioning of the buoys, may be adjusted dependent upon the prevailing surf, sweep, and beach conditions.

**Note 2:** The positioning of the judges in boats will be determined based on conditions and to ensure an unobstructed view at all times.

### **3. THE COMPETITION**

#### **3.1 Pre-Start**

- A. For each race, the boat crews shall be marshalled to their allocated positions on the beach near the water's edge with the craft being fully equipped (which includes a rescue tube).
- B. At the appropriate time for a wet start, the Check Starter shall direct the crews to float and hold their boats in their allocated positions approximately 23m apart in readiness for a race start.
- C. Starts may be wet or dry and will be decided by the Chief Referee. When a dry start is used, coloured markers corresponding with the buoy colours will be placed in line on the beach, approximately 10m from the water's edge. A crew member from each crew shall line up behind the allocated marker in readiness for a race start. The remaining four crew members shall hold the boat either floating in the water or at the water's edge. A handler may be permitted in the event of a dry start, but they must not interfere with any other crews or provide any assistance that would increase the speed of the boat they are handling.
- D. Registered team members of the same club are permitted to function as handlers. With the Chief Referee's approval, non-team members may also function as handlers. Handlers, shall not be considered to be a competitor but shall:
  - Be a minimum of 15 years of age in the year of the competition.
  - Not be required to wear a competition cap.
  - Wear an approved aquatic helmet if the conditions require.
  - Wear a distinctive high-visibility vest (or an approved lifejacket).
  - Make every effort to ensure that they and the equipment they are handling do not impede other competitors.
  - Comply with all instructions of the Officials.
- E. The Check Starter shall hold a flag aloft when the crews are in line and ready to race. At the discretion of the Sweep, a crew may draw their boat back from the line if they so wish, provided the boat is stationary at the time of the start. If crews disregard the directions of the Check Starter or Starter they may be disqualified.
- F. The Check Starter raises a flag to signal the Starter that the crews are ready to race. The Starter should be in an elevated position approximately mid-field on the beach.
- G. If a crew has a problem prior to the start, the Sweep may raise an arm to indicate that the crew is not ready to race, whereupon the Check Starter may lower their flag and the Starter may lower the gun. Once the problem has been rectified, the start process may recommence. A crew that disregards the further directions of the Check Starter may be disqualified.

#### **3.2 The Start**

The Starter shall make every effort to ensure that all crews are given a fair and even start. However, the decision for the crew to "in and away" is ultimately the responsibility of the Sweep. Crews may not protest the start.

If the Chief Referee, Starter or Check Starter is not satisfied that the start has been fair for all crews, the race shall be recalled by way of a second shot from the gun or a whistle blast.

In a dry start, the crew member runs to the boat when the start signal is given. When the crew member visibly touches the body of the boat (not the oars), the crew may board the boat and commence rowing. Failure by the runner to visibly make contact with the boat before the crew boards may result in disqualification.

#### **3.3 The Seaward Journey**

- A. On the starting signal, the boats shall be rowed to sea. Crews should endeavour to steer a straight course to their allocated turning buoy. Failure to steer a straight course to their allocated turning buoy may result in a penalty or disqualification if another crew is impeded or disadvantaged by such action.
- B. During the seaward journey, if a boat is swamped and overturns, the crew may right and empty the boat and continue the race. To achieve this, it may be necessary for the crew to return the boat to shore. If a time limit has been advised and it is clearly evident that a restarting crew will not complete the course in the allowed time, the Chief Referee should withdraw the crew from the race to prevent delays to the programme.
- C. During the seaward journey, lost or damaged boats and/or gear (e.g., oars, rowlocks, etc.) may be replaced by other club members. Club members may place replacement boats and gear for collection

at the water's edge by the crew and remove damaged or lost equipment to ensure that interference is not caused to other competing crews.

- D. Any member of any club or Official authorised to be in the competition area may assist in the removal of damaged or lost boats and/or gear from the competition area to assist in maintaining safe competition.
- E. Non-crew members may not recover lost boats and/or gear and place same on the start line for reuse by a crew during a race.
- F. Replacement gear may be brought into the Competition Arena and placed adjacent to the starting line as directed by the Chief Referee or relevant Official.
- G. If a crew runs aground while steering a straight line to their allotted turning buoy, the Chief Referee may halt the race and re-run that particular heat of the race or place the crew in another heat or round of the race.

### 3.4 The Turn

Turns are usually made from left to right (i.e., in a clockwise direction). However, this may change at the discretion of the Chief Referee after giving due consideration to the sea conditions applicable at the time of that round. All crews must be informed of a decision to change from "left to right" to "right to left." Failure to make the turn in the correct direction shall result in disqualification.

The turn shall be effected giving due consideration to other competing crews. The turn should be kept as tight as is required to avoid impeding other crews. This applies when approaching and departing the turning buoys (see diagram). Impeding another crew may result in penalty or disqualification.

### 3.5 The Return Journey

- A. After completing the turn, crews should make every effort to steer a straight course to the finish line. Failure to do so may result in penalty or disqualification if another competing crew is impeded or disadvantaged by such action.
- B. Boats taking a wave must keep clear of boats in front of them and may pass other boats on either side. Failure to comply may result in a penalty or disqualification if another crew is impeded by such action.
- C. If a crew overturns its boat after completing the turn and before crossing the finishing line (or in the case of a dry finish, the runner completing the course), the crew may continue the race after ensuring the safety of all crew members who rounded the buoys in the boat at the time of the roll over.
  - This is to be demonstrated by all crew members who were in the boat at the time of the roll over firstly completing a head count to ensure that every member is at the surface and safe and then one of the crew giving the ILS "All Clear" signal. The crew may then proceed to complete the race as described in "The Finish" section of this Section.
  - Only those crew members who rounded the buoy in the boat are eligible to assist in finishing the race.  
**Note:** Should a boat in a race cause another boat to overturn, the Chief Referee shall decide whether the affected crew may progress to the next round. However, there shall not normally be a re-run of the final in such circumstances.
- D. When gate buoys are in use, crews must pass through their allocated gate as decided by the Chief Referee. The Chief Referee shall advise crews of the boat buoy usage. Any changes made during competition shall also be advised to crews. Failure to negotiate the correct gate shall result in disqualification. If another crew cannot pass through their gate buoy as a result of failure by another crew to correctly negotiate their correct gate, the matter shall be adjudicated upon by the Chief Referee.
- E. Should a boat on the return journey, when close to the finish line be stopped by grounding, this boat shall be deemed to have finished the race. This boat may be allocated a placing as decided by the finish judges provided that the boat is not full of water and is heading towards the finish line.

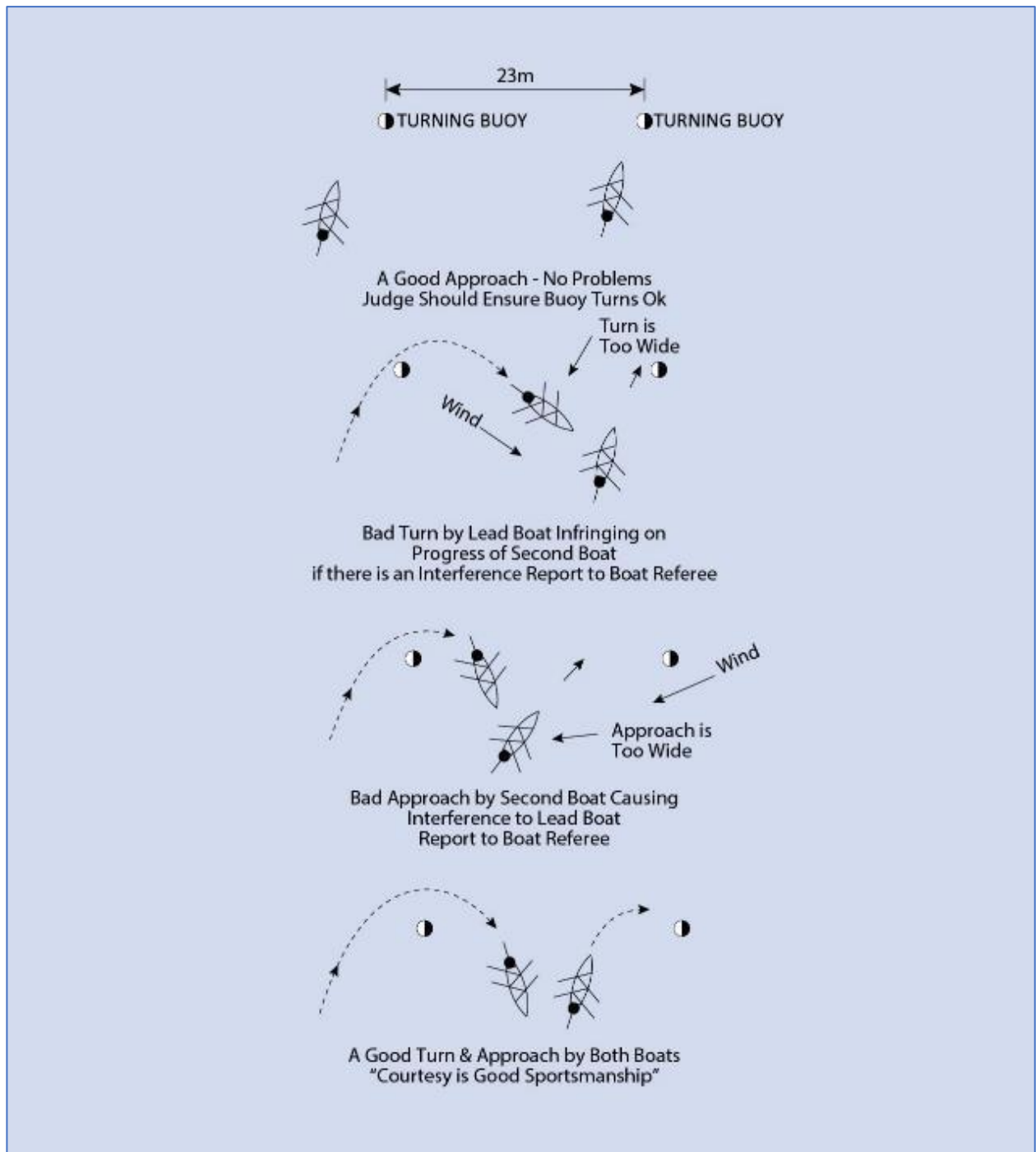

**FIGURE 38: SURF BOAT TURNS AT BUOYS**  
Some typical situations

### 3.6 The Finish

- A. A wet finish placing shall be determined when any part of the hull of the boat crosses the finish line under the control of the crew and properly equipped from the seaward side between the finishing flags or when a boat runs aground. The crew may recover a boat that has crossed the finish line not under the control and/or properly equipped and then again cross the finish line correctly to record a finish placing result.

**Note 1:** “Under control” is defined as a boat being in an upright position with a crew of at least three members in contact with the boat and the boat moving in a direction towards the finish line.

**Note 2:** “Properly equipped” to complete a finish is defined as a boat equipped with a rescue tube, a minimum of three rowing oars or two rowing oars and a Sweep oar which shall be in the boat or in the rowlocks.

**Note 3:** Where video cameras are used to assist with the judging process the judging (finish) line may be modified to accommodate the optimum use of such technology e.g., rigid poles without flags may be used. The standard finish flags may then be placed on the shoreward side of the rigid judging line poles and as close as practical to the rigid judging line poles. Boats are expected to proceed past the judging line and through the finish flags to complete a race.

- B. A dry finish is determined when a crew member leaves the boat and runs to their allocated position marker and crosses the line. The crew member may leave the boat at any time after the turn has been completed and must cross the line while remaining in an upright position on their feet.
- C. An alternate to crossing the line to finish may be prescribed by the Chief Referee. In such circumstances, the crew member leaves the boat as described and then is required to touch the crew’s finish marker while remaining on their feet.
- D. Any boat that dislodges a judging stand so as to impede judging shall be disqualified. If one boat causes another boat to dislodge a judging stand, the matter shall be adjudicated by the Chief Referee.

### 4. RACING FORMAT

- A. The ILS may conduct surf boat events in either “Elimination,” “Round Robin,” “Other,” or a combination of racing formats.
- B. In consultation with the Surf Boat Panel, the Organising Committee or Chief Referee shall decide the racing format and advise competitors accordingly prior to the commencement of the competition, or prior to the first round of each boat race.

**Note:** If conditions dictate, and in consultation with the Surf Boat Panel, the Organising Committee or Chief Referee may vary the racing format during the competition.

- C. The standard format for the conduct of round robin racing is described in 6.10 below.

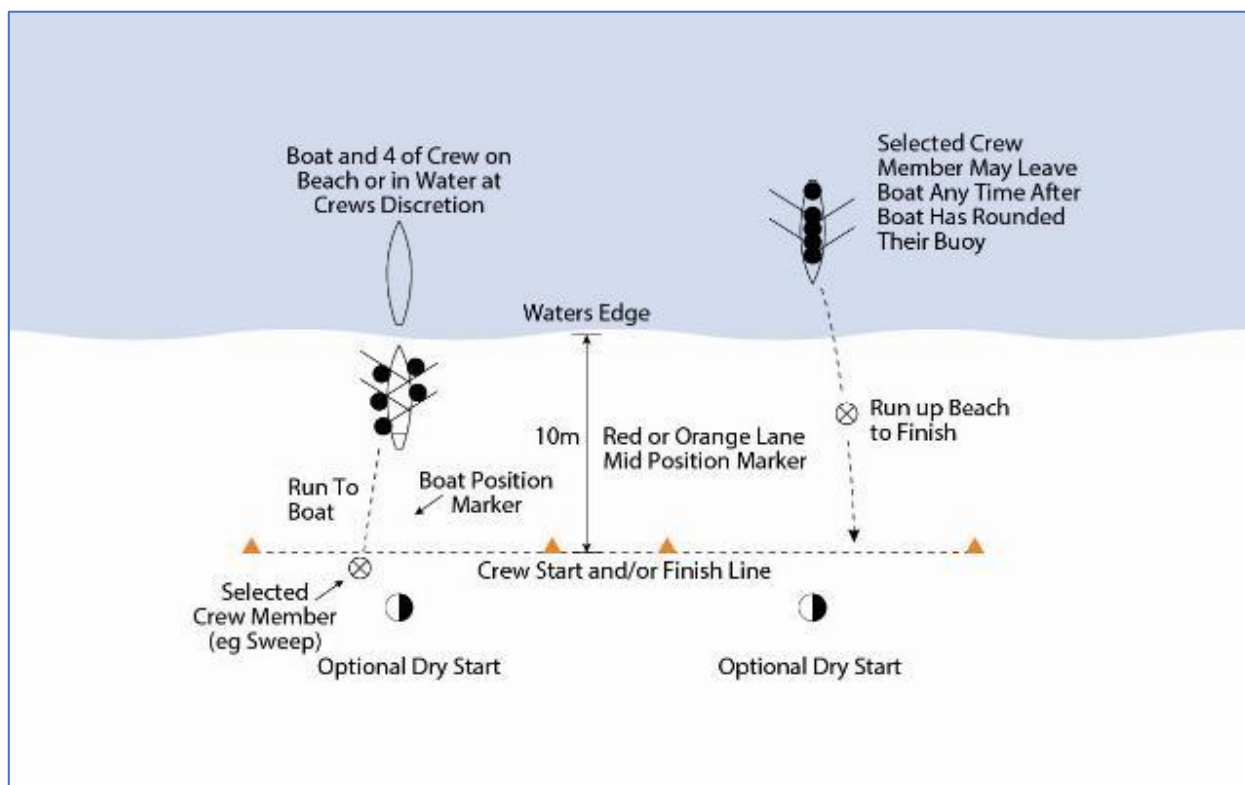

FIGURE 39: SURF BOAT RACE OPTIONAL START AND/OR FINISH

## 5. ROUND ROBIN RACING

Surf, beach, weather, and time constraint issues conditions permitting, “Round Robin” racing may be conducted over three rounds to determine qualifiers to further rounds of competition in boat events. Progression into further rounds and finals shall then be by elimination. The conditions detailed are not subject to protest.

Qualifiers to further rounds of the competition will be determined based on total points gained in the rounds of the round robin (unless otherwise disqualified from the event). The points available in each of the rounds of the round robin are as follows:

- 1st place: 10 points
- 2nd place: 9 points
- 3rd place: 8 points
- 4th place: 7 points
- 5th place: 6 points
- 6th place: 5 points
- 7th place: 4 points
- Did Not Finish (DNF): 3 points
- Did Not Start (DNS): 0 points
- Disqualification (DQ): 0 points

**Note 1:** A Did not Finish (DNF) result and points may be allocated to crews who have made a “reasonable attempt” (as determined by the Chief Referee or their designate) to complete the course in the allowable time limit (if established).

A reasonable attempt may be defined as a crew:

- Making continuous attempts to complete the course and have been significantly impacted by forces outside their control (e.g. surf conditions or other crews) and time has been exhausted.
- Being directed by an Official not to re attempt the seaward journey after they have correctly reset their boat and equipment from an earlier incident in the race

- Being directed to get into/on a safety craft and are therefore unable to get into their boat to attempt to complete the course.

**Note 2:** If a crew finishes a race without incident but are outside the finish area (as per Rule S6 3.6 A) or a set time limit (as per Rule S4 3.2), the crew shall be disqualified and allocated zero points for that round.

**Note 3:** It is not always possible to have heats of equal size within a round of a division. For example, a round may have two heats of five crews and one heat of six crews. Crews shall be allotted the points based on the position they cross the line (or otherwise), regardless of their heat size.

In the event of a dead heat in an individual round of the round robin, equal points shall be allocated for the placing achieved. For example, if two crews finish equal first in a race, they shall be awarded 10 points each, with the crew finishing third being awarded 8 points.

At the completion of the Round Robin racing any crews on equal points who are in contention to qualify for future racing, or to determine an overall final result (if no finals are planned to be conducted - see notes below), result shall be decided on the following basis:

- The crews involved will be compared firstly on head-to-head results, with the winner of the head-to-head qualifying to the next (elimination) round of racing.
- For example, if Crew A and Crew B only raced each other in heat two of the second round and Crew A beat Crew B in that race, then Crew A will qualify for the next round.
- If the crews have not raced each other, or are still equal after comparing head-to-head results, the relative places from all round robin racing will be reviewed and the crew with the highest individual placing will proceed over the other crews.
- For example, if one of the crews on equal points has a first place, they will proceed over other crews who did not receive a first place in the rounds. This comparison will continue for second, third etc., places until there is a clear qualifier.
- If the crews are still equal after both of these comparisons, then the round robin result will be declared a dead heat between the crews involved (as per Rule 2.24). All crews achieving the dead heat will share the round robin finish result and/or be allowed to progress in the competition.

**Note 1:** If no finals are able to be conducted after the conclusion of round robin racing, (e.g. deteriorating ocean and/or weather conditions) the Chief Referee, in conjunction with the Competition Committee, shall decide whether the procedure detailed above will decide whether it is appropriate to declare an overall result or to abandon or postpone the event.

**Note 2:** If no finals are planned to be conducted after the conclusion of round robin racing (e.g. an event involving up to, say six crews where a single final is not appropriate) the procedure detailed above will determine the overall event winner and placegetters.

- Prior to the first round of an event commencing the Chief Referee shall advise the number of qualifiers to progress to the elimination rounds of each division of competition or the finals (as appropriate).
- If a crew is disqualified from a round robin race (other than for Competing Unfairly, Abuse/Inappropriate Behaviour or a Code of Conduct breach), they will receive zero points for that round but may be permitted to continue to compete in any following rounds.
- If a crew is disqualified in a round for a serious discipline offence (e.g., Competing Unfairly, Abuse/Inappropriate Behaviour or a Code of Conduct breach - as detailed in Section 2), they are disqualified and lose all standing in the event. Other penalties may also apply.
- If a penalty is applied a crew may continue in an event or be allocated placings or points (in the round robin) or be eliminated from a round or event as determined.
- A "penalty" is defined as a punishment or consequence as a result of an infringement or breach of the competition rules. Penalties may include but are not limited to:
  - Allocation or reallocation of placing(s) (and therefore points in the round robin). In such circumstances the aggrieved crew may be allocated or reallocated placings and therefore points, and the crew may be permitted to continue through to the following round if they qualify on points.
  - Elimination from a round in round robin racing (but allowed to continue) in the event. In such circumstances zero points will be allocated to the crew in that particular round of the round robin, and the crew may be permitted to continue through to the following round if they qualify on points.
  - Total disqualification from the event.

## 6. PENALTIES AND DISQUALIFICATION

In addition to the General Rules in Section 2, and Ocean Events in 4.1 through 4.3, the following behaviour shall result in disqualification: Failure to complete the course as defined and described (DQ 11)

## 7. DISQUALIFICATION CODES FOR SURF BOAT EVENTS

Code and Disqualification	Events
1. Not competing in accordance with the general rules.	All events
2. A competitor or team may be disqualified if a competitor, team, or handler is deemed to have competed unfairly. Examples of “competing unfairly” include: <ul style="list-style-type: none"> <li>• Committing a doping or doping-related infraction.</li> <li>• Impersonating another competitor.</li> <li>• Attempting to defeat the ballot or draw for events or positions.</li> <li>• Team competing twice in the same event.</li> <li>• Individual competing twice in the same event in different teams.</li> <li>• Purposely interfering with a course to gain advantage.</li> <li>• Jostling or obstructing another competitor or handler so as to impede their progress.</li> <li>• Receiving physical or material outside assistance (other than verbal or other direction).</li> <li>• Participating contrary to the spirit of the competition (as described in the code of fair play).</li> </ul>	All events
3. Competitors may not be permitted to start in an event if they are late reporting to the Marshalling Area. This may be noted as a “did not start” (DNS) or similar on the result sheet.	All events
4. A competitor or team absent from the start of an event shall be disqualified. This may be noted as a “did not start” (DNS) or similar on the result sheet.	All events
5. Activities that result in wilful damage to the venue sites, accommodation sites or the property of others will result in disqualification of the individuals involved from competition.	All events
6. Abuse of Officials may result in disqualification from the competition.	All events
7. The first competitor or team to start (i.e., commence a starting motion) before the starting signal has been given shall be disqualified.	All events
8. Failing to comply with the starter’s commands within a reasonable time.	All events
9. A competitor who, after the starter’s first command, disturbing others in the race through sound or otherwise may be disqualified.	All events
10. Starting from a position other than the allotted position or lane.	All events
11. Failure to complete the event and/or course as defined and described.	All events



**World Water Safety**  
**INTERNATIONAL LIFE SAVING FEDERATION**

**ILS COMPETITION RULE BOOK**  
**SECTION 7**  
**INFLATABLE RESCUE BOAT COMPETITION**



**2025 EDITION**  
**(Revised May 2026)**

## SECTION 7

### INFLATABLE RESCUE BOAT (IRB) COMPETITION

The aims of IRB competition are to:

- Improve the prowess of IRB drivers and crewpersons (collectively referred to as 'crew').
- Encourage crews to correctly equip and maintain their IRB and motors for optimum safe performance and reliability for both lifesaving patrol duties and competition.
- Allow crews to demonstrate their techniques and their abilities to perform a rescue.
- Bring crews together to discuss and improve IRB techniques and operations.
- Promote safety awareness techniques for the crewpersons and patients in simulated rescue scenarios.

#### 1. INDEMNITY

All IRB competition participants acknowledge and agree that:

- A. They each release and will release ILS and/or their ILS Member Organisation from all claims that they have or may have had but for this release arising from or in connection with their membership of the ILS and/or their ILS Member Organisation and/or participation in any ILS and/or their ILS Member Organisation authorised or recognised competition or activity whether conducted under this rule book or otherwise.
- B. They each indemnify and will keep indemnified the ILS and/or their ILS Member Organisation to the extent permitted by law in respect of any claims arising as a result of or in connection with their membership of the ILS and/or their ILS Member Organisation and/or participation in any ILS and/or their ILS Member Organisation authorised or recognised competition or activity (whether conducted under this rule book or otherwise).
- C. In paragraphs A. and B. above the word "claims" means and includes any action, suit, proceeding, claim, demand, damage, penalty, cost, or expense however arising but does not include a claim in respect of any action, suit, etc., made by any person entitled to make a claim under a relevant ILS and/or their ILS Member Organisation insurance policy or under the ILS and/or their ILS Member Organisation constitution or regulations.
- D. The rules contained in this rule book are made for the purpose of ensuring a safe and fair system or framework within which lifesaving competitions are to be regulated and conducted.

#### 2. GENERAL CONDITIONS

In addition to the specific rules and procedures governing events, team management and competitors are responsible for being familiar with the general conditions outlined below as well as those outlined for Ocean Competition in S4-1 – specifically A., B., and E. through to J.

##### 2.1 Safety essentials

- A. **Warning:** IRB competition can be inherently dangerous. IRB competition participants acknowledge that they are exposed to certain risks during IRB competition including but not limited to leg, spinal and neck injuries, physical exertion, contact with the IRB, temperature, weather, and water conditions and even drowning. IRB competition participants acknowledge that accidents can and often do happen which may result in IRB competition participants being injured or even killed. All members through their participation in IRB events agree with, acknowledge, and understand this warning and accept and assume the inherent risks in IRB competition.
- B. The Chief Referee must be satisfied that the surf and other relevant conditions are satisfactory before competition proceeds and at all times during the conduct of competition. The ILS event safety guide may be used to assist in the process. The Chief Referee shall confirm details at safety briefings (see S7-2.2).
- C. **Safety Procedures:** Course Judges will monitor and observe all driving, operating, safety practices and techniques. Should such practices and techniques be considered to be unsafe, dangerous, or contrary to the rules or procedures of the event the Course Judges are to report their observations to the Chief Referee with a recommendation as per their authority. The Chief Referee has the authority to immediately disqualify the offending competitor(s) from the event and/or issue a safety infringement. Recommendation for further penalties and/or referral to the Disciplinary Committee may also be considered.

- D. **Equipment Safety:** Scrutineers and Chief Referees (or their designate) will monitor the safety of all equipment used in the competition and are empowered to request repair and/or substitution of unsafe or dangerous equipment at any stage of competition.
- E. **Helmets:** The wearing of approved (EN1385 or equivalent) aquatic helmets is compulsory for drivers, crewpersons, and patients in all events. IRB patients are to wear helmets in both training and in competition. It is not required to wear caps under helmets. See also S2.10F. Competition Caps and Helmets and S8-4.7.
- F. **Personal Flotation Devices (PFDs):** The wearing of approved PFDs (ISO 12402.5 PFD – Level 50 or equivalent) is compulsory for drivers, crewpersons and patients in both training and competition. It is not required to wear high visibility vests under PFDs. See also S2-10C. Flotation vests and S8-4.6.
- G. Signs or banners shall be displayed to provide a 50m buffer zone on either side of the competition area. These may be the same signs used to indicate IRB training and shall be a minimum of 1 m x 1 m. The text of the banners shall be in English and in the Official language of the host Organisers. For example:

‘CAUTION - KEEP CLEAR - POWER RESCUE BOAT TRAINING’

Or

‘CAUTION - KEEP CLEAR’

Or

‘INFLATABLE RESCUE BOAT – RESCUE EVENTS’

- H. IRB drivers must be mindful of local country/state/province, etc. laws respecting alcohol and certain drugs when operating craft. Drivers may be subject to testing by local authorities and/or the ILS to ensure they do not infringe local laws or ILS policies. All competitors in IRB events are also reminded of the ILS drug policy and doping controls. All competitors may be subject to other drug testing.

## 2.2 Pre-competition safety briefing

A safety briefing may be conducted in conjunction with the Officials, coaches and team managers briefing before the commencement of IRB competition. The following items may be included:

- An explanation of all safety procedures that shall be observed by all competitors.
- Patient care and indicative water temperature.
- Identification of the location of emergency and first aid areas during the competition.
- Forecast of surf and weather conditions for the competition period and any inherent dangers.
- Safety and Rescue Plans and Contingency Relocation Plans.
- Attention shall be drawn to S2-3 Competition Safety.

## 2.3 Safety and technical infringements

A strong emphasis will be placed on safe driving, crewing, and patient practices. All competitors must complete each event in a safe and controlled speed and manner or face immediate disqualification from the event, and/or issue of a safety infringement and consideration for further penalties.

- A. The Chief Referee or their deputy shall issue a safety infringement to any competitor deemed to have committed an unsafe practice. This will result in immediate disqualification of the competitor and their entire team (i.e., driver/s, crewperson/s, and patient/s) from the event in which the infringement occurred. The Chief Referee may (not compulsory) also issue a yellow card to indicate a first safety infringement and disqualification from the event.
- B. A competitor who receives more than one safety infringement in any one competition, shall be disqualified from the entire competition. The Chief Referee may also (not compulsory) issue a red card to indicate a second safety infringement and disqualification of the competitor from the entire competition.
- C. A team that incurs a safety infringement shall earn zero points in that event to any point score being conducted.
- D. A technical infringement is one where a team is disqualified from an event for a breach of rules not related to safety or for non-completion of an event. Such disqualifications may not affect a team's participation in further events in the competition.

- E. If a technical infringement occurs in a final, a team shall be allocated points towards any point score as detailed in the Championship's Handbook.
- F. Safety and technical disqualifications for IRB competition are detailed at the end of this Section.
- G. The Chief Referee or their Deputy shall advise team managers of any disqualification immediately after each heat, round or final.

## 2.4 Competitor prerequisites

To compete in ILS IRB competition, competitors must be a minimum of 15 years of age in the year of the competition, or an older age if required by their ILS Member Organisation and be endorsed by their lifesaving organisation to compete.

In addition:

- A. Drivers must be a minimum of 18 years of age in the year of the competition, or older if required by their ILS Member Organisation. Drivers are required to hold their ILS Member Organisation's IRB driver award (or equivalent); any other requisite awards including statutory driving licences and be currently proficient as required by their lifesaving organisation.
- B. Crewpersons must be a minimum of 16 years of age in the year of the competition and are required to hold their ILS Member Organisation's IRB crewperson award (or equivalent) and any other requisite awards and be currently proficient.
- C. Patients (or victims) must be a minimum of 15 years of age in the year of the competition and are required to hold their ILS Member Organisation's lifesaving award and any other requisite awards and be currently proficient.
- D. Registered team members of the same team including managers, coaches, and other team personnel are permitted to function as handlers. With the Chief Referee's approval, non-team team members may also function as handlers. Handlers, shall not be considered to be a competitor but shall:
  - Be a minimum of 15 years of age in the year of the competition.
  - Hold their ILS Member Organisation's requisite lifesaving and IRB award(s) and be currently proficient.
  - Not be required to wear a competition cap.
  - Where an approved aquatic helmet if the conditions require.
  - Wear a distinctive high-visibility vest (or an approved lifejacket).
  - Make every effort to ensure that they and the equipment they are handling do not impede other competitors.
  - Comply with all instructions of the Officials.

## 2.5 Entry limitations and substitutions

- A. Competitors may only compete in a particular event once, e.g., a driver cannot compete in the same event on a different team as a crewperson or patient. However, eligible competitors may change their role within a team in different heats of the same event. Team substitutions are permitted only if a team member is entered for the competition and has not already competed in the same event as a member of another team.
- B. Unless event specific conditions dictate otherwise (e.g., IRB National Teams Lifesaving World Championships), IRB patients are considered gender neutral with respect to their participation in male and female IRB events.
- C. Should a member of any crew become indisposed, he or she may be replaced subject to approval of the Chief Referee, provided the competitor complies with the requirements for team substitution, overall team size (which cannot be increased) and any special entry conditions.

**Note:** For substitutions in ILS National Teams IRB LWCs please refer to the ILS LWC Handbook.

## 2.6 Equipment requirements, scrutineering, and compliance

- A. Organisers are to advise whether IRB competition equipment will be provided on a pooled basis or whether competitors may use their own equipment.
- B. All IRBs and equipment shall comply with the specifications of the ILS and may be subject to scrutineering to ensure compliance with specifications and for safety.
- C. Video cameras may be mounted on IRBs as long as such devices conform to the requirements specified in Section 8, With the exception of the IRB driver, video cameras may not be worn by or otherwise attached to a competitor from start to finish of a race.

- D. The IRB driver may wear a video camera on their helmet, provided that the camera is installed on a mounting device and toggle strap supplied or recommended by the manufacturer of the device.

## 2.7 The course

- A. The course for IRB competition shall be as detailed in the diagram and set at the discretion of the Chief Referee.
- B. A 'lane' is defined as an area centred on a line of sight from the 'beach position marker,' located on the 'start/finish line,' and the relative 'turning buoy.'
- C. Lanes are bounded by 'lane marker' poles (typically red or orange in colour) that are placed in a line parallel to the start/finish line and approximately 10m from the water's edge. These poles form the "changeover line" used for the tag in the teams and relay events. The beach position markers are placed in the centre of the lane and approximately 5meters behind the changeover line.

**Note:** For the IRB Teams Rescue event a pole is to be placed directly behind the beach position marker and is to extend approximately 1.8m out of the sand to assist with ensuring the correct changeover procedure. Alternatively, 1.8m high (approximate) beach position markers may be used for all events.

- D. The turning buoys shall normally be set at a minimum measured distance of 120m from the end of knee-depth water at the low tide mark and taking into account varying conditions such as sandbars, exclusion of holes and rips, surf conditions, prevailing winds, and safety factors.
- E. The 'patient pick-up buoy' for the rescue, mass rescue and teams rescue events is positioned approximately 10m directly behind the turning buoy.
- F. The 'rescue tube patient buoy' for the rescue tube event is positioned approximately 25m directly behind the turning buoy.

## 2.8 Course variations

- A. **Water Start:** If the Chief Referee decides that the start shall be in the water, the start/finish line shall be located 10m from the water's edge. The beach position turn markers shall be placed 5m shoreward from the start/finish line.
- B. **Curved Beach Start:** Crews are positioned to take into account the curved nature of the beach.
- C. **Water Finish:** Normally (as per the diagram), the finish is dry and within the crews' allotted lane markers unless the Chief Referee decides on a water finish. In a water finish, the team is deemed to have finished once any part of the hull of the IRB crosses the finish line from the seaward side between the two finishing flags/poles or finish gates.
- D. **Curved Beach Finish:** Drivers shall be required to run up to the start/finish line and raise the team's beach position flag above their head while remaining on their feet.
- E. **Electronic Finish:** Drivers shall activate an electronic device at the start/finish line to register the finish and be on their feet when the device is activated.

## 2.9 Administration and Officials

- A. Events may be held separately or as part of a surf competition and, as such, will come under the overall control of the Chief Referee.
- B. The Chief Referee shall have knowledge of ILS competition, the ILS Competition Rule Book and any relevant circulars regarding the competition and IRB operations.
- C. Other Officials shall be appointed to assist the conduct of the competition. In addition, specialist advisers (e.g., hull and motor experts etc.) may be appointed to assist.

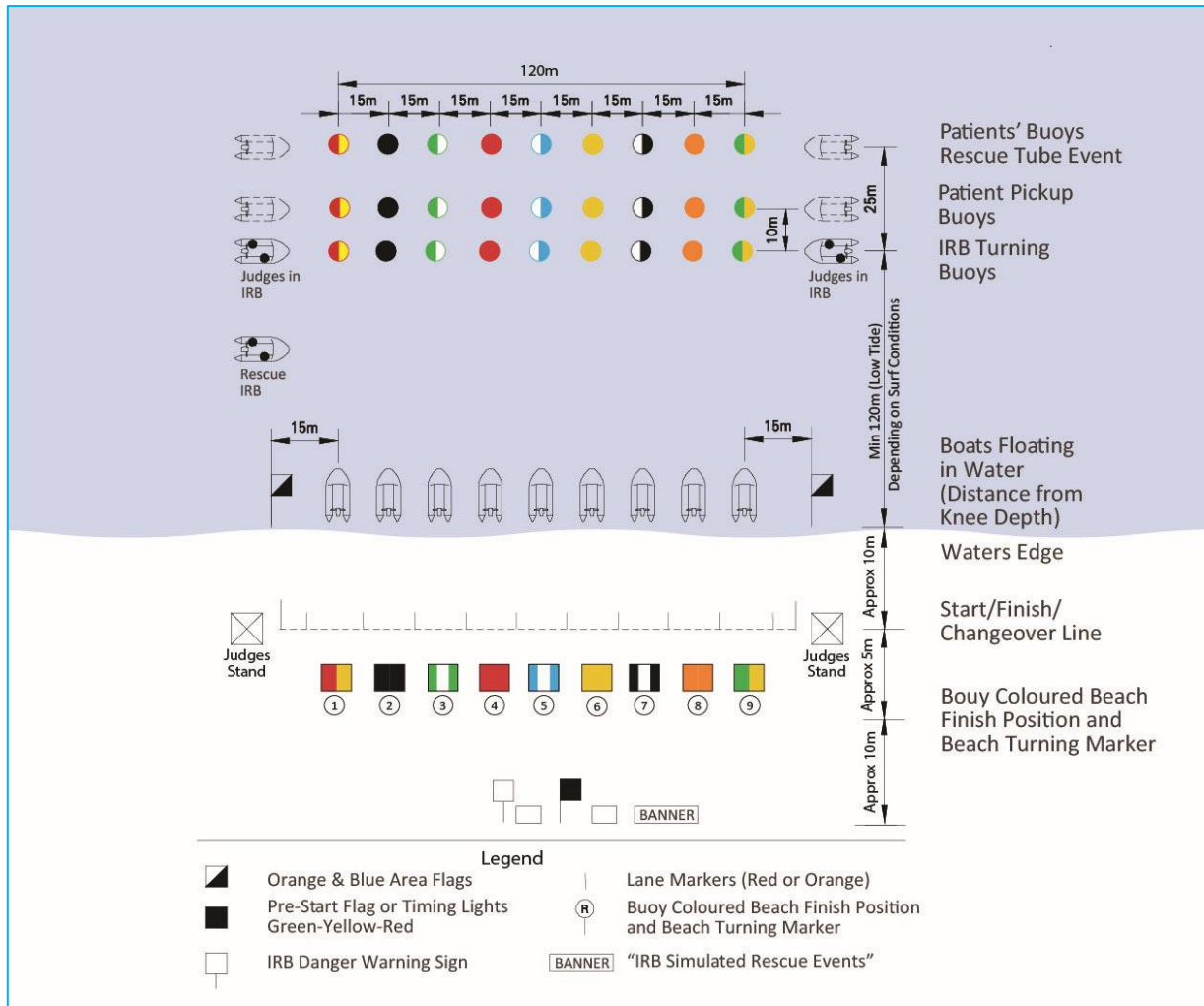

**FIGURE 40: TYPICAL IRB COMPETITION AREA**  
 (Distances approximate only)

**Note:** The layout of the Competition Arena, including the beach setup relative to the positioning of the buoys, may be adjusted dependent upon the prevailing surf, sweep, and beach conditions.

### 3. PROCEDURE

#### 3.1 Placing of patients

- A. Patients, wearing helmets, shall be taken to sea by either the duty boats (preferred) or their own crews. Patients shall be placed in the water at their allocated patient pick-up buoy. For the rescue tube event the patient shall be placed at the allocated rescue tube patient buoy.
- B. Patients may hold onto their buoy until the patient pick-up. Patients are not permitted to attempt to move the buoy in any direction to gain an advantage. For the pick-up, they shall release all contact with the buoy and position themselves clear of and behind their pick-up buoy on the seaward side.
- C. In the mass rescue and teams events the second patient will wait on the beach side of the pick-up buoy and move to the seaward side of the buoy after the first patient has been picked up and the IRB has crossed back to the shoreward side of the pick-up buoy.

#### 3.2 Preparing for the Start

- A. All competitors in IRB events wear approved aquatic helmets and approved PFDs. Drivers are to wear the identifying-coloured apparel of their allocated lane.
- B. Patients shall assemble in the Marshalling Area. The Marshall shall inform each team of their allocated lane. The remainder of the crew go directly to their allocated lane with their IRB in preparation for the start.
- C. Crews are able to claim bonus time. This is an optional concession, provided at the discretion of the Chief Referee, for crews at the start of events. Each club is allowed a maximum of five minutes bonus time per day of competition, which may be claimed in a minimum of one-minute increments.
- D. The process of starting events should commence with a signal or command that indicates “Take Your Marks” followed by a signal or command that indicates “Set” and then followed by a start signal or command that indicates “Go.” If, for any reason, the Starter has to speak to any competitor after either command, the start process shall be recommenced.
- E. On the “Take your Marks” signal from the Starter (usually by whistle or verbal command), the crew shall position themselves on the start line and the IRB shall enter the water and be held at the desired depth within their allocated lane. Check Starter/s may be utilised to guide crews to their starting position. Handlers may assist with the positioning of the IRB.
- F. Two handlers may hold the IRB to assist with keeping it in place for the start. The motor may be in or out of gear. The handlers may move the IRB at any time (including prior to and after the start signal) as long as the boat is in the “correct IRB starting position” when the driver or crew first make contact with the boat.

**Note 1:** The “correct IRB starting position” is defined as the boat being stationary, with the bow facing towards the wave line within its lane and positioned not to disadvantage other competitors, at a depth of water as determined by the handlers. It is also permitted for the IRB to be placed at an angle to assist driver and/or crew entry if it is safe to do so.

**Note 2:** If conditions warrant the Chief Referee may increase the number of handlers to four.

- G. The driver and crewperson shall be positioned adjacent to their respective beach position marker in readiness for a race start with their foot on or behind the start/finish line. If a lane-coloured vest is supplied, it must be worn by the driver/s as directed by the Chief Referee.

**Note:** The definition of foot includes any part of the foot, heel, and/or toes.

- H. The Starter then gives the “Set” signal (usually by whistle). Crews may claim bonus time up to and including at the whistle for the set signal. Should IRB equipment be damaged by waves while in the set position and before the start the Chief Referee may, at their discretion, allow for the equipment to be replaced or quickly repaired before proceeding with the start without the loss of bonus time.

#### 3.3 The start

- A. On the starter’s “Go” signal (usually by starting gun or horn) the driver and crewperson shall proceed to the IRB. A break shall be adjudicated as detailed in Section 4 (Ocean Events) of this Rule Book.

**Note 1:** Although the Starter should make every effort to effect a fair and even start, the decision to “Go” on the start signal rests with the competitor or team. If there is no recall by the Starter or the Check Starter(s) or the Chief Referee, no protest shall be allowed on the start.

- B. Any handlers used are to be on either side of the IRB and must hold or control the IRB with at least one hand. Handlers must not be in contact with any part of the motor and/or fuel cell, fuel line assembly, and/or safety chain when the starting signal sounds.
- C. Handlers are permitted to move the IRB at any time including after the starting signal to assist with water depth, positioning of the IRB and to maintain the bow seaward towards the wave line. It is also permitted for the IRB to be placed at an angle to assist the driver and/or crewperson entry if it is safe to do so. At the time the driver or crewperson first makes visible contact with the boat, the IRB must be in the “correct starting position” and the handlers shall not further move the boat and must release contact and move safely clear as the engine propels the IRB forward or prior to if safe to do so.
- D. The driver and crewperson, at their own discretion, shall board the IRB.
- E. The driver starts the motor only when aboard the IRB. Only the driver may start the motor, and the crewperson must be in contact with the IRB at the time the IRB is propelled forward. During the course of any IRB race only the driver is permitted to touch any part of the motor once the starting signal sounds.
- F. The motor may be started either in gear or out of gear. If starting the motor in gear and using one hand to start, the driver must maintain control of the motor throttle grip with their other hand. If a two-handed start is used the motor must be in neutral.
- G. During and immediately after starting the motor, the IRB must not move in an uncontrolled or unsafe fashion.

### 3.4 Proceed to and from buoys

- A. The decision to proceed to sea is ultimately the responsibility of the driver and crewperson.
- B. After entering the IRB, the driver and crewperson must maintain their ‘normal position’ as described below. This must be done in a safe manner with three secure points of contact maintained at all times.
- C. The normal driving position is defined as left or right foot in the foot strap, left hand holding the driver pontoon handle, right hand holding motor throttle grip, and seated on the pontoon.
- D. The normal crewperson position is defined as left foot in the foot strap (right foot in foot strap is optional), left hand holding the bow rope or handle, right hand holding the inner pontoon (boarding) handle or lifeline rope.

**Note:** The crew are not permitted to sit on the floor of the IRB. It is recommended that, where practical crews, are to be seated on the pontoon.

- E. The normal patient position is defined as positioned inside the IRB and holding onto the pontoon lifeline rope with at least one hand.  
**Note:** While not a disqualification point, patients are not encouraged to sit on the floor of the IRB.
- F. The only exceptions to the normal positions (above) are listed below. Transition from the normal positions must be made in a safe manner while maintaining three points of contact with the IRB at all times:

- The driver and/or crewperson may leave their normal position to drag the IRB over a sand bar if the motor is electrically dead, or in the neutral position if left running.
- The crewperson may rise from the seated position at any time to absorb the impact of negotiating a wave or swell.
- The crewperson may move into other safe crewing positions when heading to sea and when necessary, including but not limited to, ‘punching’ a wave.

**Note 1:** For crew guidance an “other safe crewing position” is one that allows the crewperson to streamline their body position with the craft in order to stay in better contact with the vessel through manoeuvres. This position is regarded as more secure position for crewing and can be used at any time the crewperson feels it necessary. It is ideally used when negotiating unbroken waves that are about to drop onto the IRB e.g., punching a wave.

**Note 2:** A shift from the respective normal position of the driver, crewperson, or patient(s) is permitted provided that the team member does not otherwise become dislodged from their correct position.

- G. The driver and crewperson must maintain control of the IRB at all times during the competition to ensure it moves in a safe and controlled manner. Losing the bow rope is a Safety DQ.
- H. The leading IRB, while proceeding to and from the buoys, shall, in the normal course, have right-of-way and the trailing IRB must take evasive action by turning or giving way to prevent collision.

**Note 1:** If at any time the leading IRB's driver considers that there is a risk of collision with the trailing IRB, then the leading craft should take all measures necessary to avoid a collision but in terms of competition adjudication the trailing IRB remains responsible for giving way to the leading craft.

**Note 2:** The standard avoidance measure, when on a direct collision course, is to steer right and pass safely to the port (left) side.

### 3.5 The turn and patient pick-up

The turn and patient pick-up process shall be as follows for the rescue, mass rescue and teams rescue event:

- A. Crews must not steer a wide course or delay a turn which impedes the progress of another crew or forces them from their true course.
- B. All buoys shall be rounded from right to left (i.e. in an anti-clockwise direction) and the turn is to be initiated on the port (left hand) side of the IRB.

**Note:** For judging purposes, the buoy may be submerged without disqualification while rounding the IRB turning buoy and/or at the patient pick up buoy i.e. it is not judged where the buoy surfaces provided that the turn around the buoy is correctly initiated.

- C. The IRB shall turn the allocated turning buoy and proceed to the allocated patient pick-up buoy aligning the patient to the port side.
- D. With the exception of the Rescue Tube Race, where the patient pick-up procedure is described in the rules, the patient will face towards the IRB in preparation for the patient pick-up. The patient's hands must be clasped together, or one handheld to the opposite wrist during the pick-up.
- E. The patient pick-up shall commence on the seaward side of the pick-up buoy. The driver and crewperson may both assist with the patient lift.
- F. Once the patient pick-up has commenced the IRB shall complete the turn, pass back to the beach side of the patient pick-up buoy, and return to shore. In the mass rescue this procedure is repeated for the second patient pick-up.
- G. The patient must be wholly clear of the water by the time the IRB has passed the crew's IRB turning buoy (judged at the trailing edge of the motor) on the return to the beach.
- H. The IRB shall not turn around any buoy other than the allocated turning buoy and the allocated patient pick-up buoy.
- I. If an IRB crew misses the patient pick-up, to correctly complete the course they must continue to their respective turning buoy a second time without penalty, round it and re-attempt the patient pick-up as described above.

### 3.6 The exit and finish

- A. The IRB shall be beached and remain on or within the allocated lane and not be positioned to disadvantage other teams until the driver has exited the IRB.
- B. When grounding or beaching the IRB at the finish of a race the driver, crewperson or patient must not be dislodged. The crew must maintain three points of contact.
- C. When beaching the IRB, the driver must render the motor electrically dead by activation of motor kill switch before the driver, crewperson or patient exits the IRB.
- D. The patient must not exit prior to the driver. The crewperson may alight before the driver to steady the IRB but only after the motor has been made electrically dead. The motor may be left in gear. The crewperson may use the side lifting handles while preparing for and during the exit procedure.
- E. When exiting the IRB, the driver must keep both feet on the IRB floor until the motor is electrically dead.
- F. The driver must remain seated until both feet are swung outside the IRB. The definition of 'outside' is past the centreline of the port side pontoon.

**Note 1:** If the boat becomes stationary the driver may exit the boat in a safe manner without disqualification.

**Note 2:** The driver stumbling or falling over is not a disqualification provided that they cross the start finish line on their feet.

**Note 3:** Falling across the line is not deemed to have finished the event. For the avoidance of doubt one foot must be grounded on or over the finish line for the competitor to be deemed to have correctly finished a race.

- G. The crewperson shall remain in control of the IRB while the driver runs to the start/finish line. The patient may assist the crewperson in the control of the IRB.
- H. The driver must be outside the IRB and on his/her feet when they cross the finish line at the end of an event. The exception to this is if the Chief Referee or their designate has advised that the finish will be a “water finish” as defined in S7-2.8C.
- I. The finish is judged on the chest of the driver when he or she crosses the start/finish line on their feet.  
**Note:** IRB teams are requested to stand away from the start/finish line when finished until all teams have completed the course. This will assist with the judging process.
- J. Unless otherwise specified (e.g., a water finish detailed in S7-2.8C, a team shall not drive the IRB across the finish line to record a finish result. The driver must be on their feet and outside the IRB when they cross the finish line. Should an IRB cross the finish line, the driver may exit the boat and pass to the seaward side of the start/finish line and re-cross the line on their feet to record a finish result.

### 3.7 The Changeover (Mass and Teams events only)

- A. During all changeovers, the crewperson must maintain contact with the IRB and control it in a safe manner. In changeovers the crewperson/s and/or patient, as detailed under the relative event descriptions, may assist with relaunching of the IRB, but must release contact and move safely clear as the engine propels the IRB forward or prior to if safe to do so. For the second and subsequent legs it is also permitted for the boat to be placed at an angle to assist driver entry if it is safe to do so.  
**Note 1:** During changeovers, drivers, crewpersons, and patients must follow the exit procedures detailed in S7- 3.6.  
**Note 2:** The IRB must recommence from a position on or within the allocated lane but there is no penalty should an IRB move outside the allocated lane when turning the IRB around provided that there is no interference to other teams in the race.
- B. For the changeover in the Teams event, the first and second drivers must visibly tag. To do this, the first driver proceeds to the start/finish/changeover line, rounds their respective beach position marker (see 7.2.7 c) in either direction (i.e. clockwise or anti-clockwise at the driver’s discretion), and visibly touches (tags) with the second driver who is positioned with their foot on or behind the shoreward side of the start/finish/changeover line. The second driver is not required to be stationary, but the tag must occur within this area which is called the changeover zone.  
**Note 1:** For the IRB Teams Rescue and the IRB Relay events a pole is to be placed directly behind the beach position marker and is to extend approximately 1.8m out of the sand to assist with ensuring the correct changeover procedure. Alternatively, a 1.8m high beach position markers may be used for all events.

## 4. IRB RESCUE

- A. Each team shall comprise one driver, one crewperson and one patient.
- B. The patient is positioned as described in S7-3.1.
- C. The start shall be as described in points S7-3.2 and S7-3.3.
- D. The crew shall proceed out to sea, pick up their patient and then return to shore, as described in S7-3.4 and D7-3.5.
- E. The finish shall be as described in S7-3.6.

## 5. IRB MASS RESCUE

- A. Each team shall comprise one driver, one crewperson and two patients.
- B. Both patients are positioned as described in S7-3.1.
- C. The start shall be as described in S7-3.2 and S7-3.3.
- D. The crew shall proceed out to sea, pick up their first patient and then return to shore, as described in S7-3.4 and S7-3.5.
- E. The driver shall exit as described in S7-3.6. At the shore, the crewperson controls the IRB as described in S7-3.7 and may turn it around. The patient must exit the IRB after the driver exits. The patient is permitted to assist the crewperson relaunch the IRB as described in S7-3.7(a). It is also permitted for the boat to be placed at an angle to assist driver entry if it is safe to do so.
- F. The driver proceeds to the start/finish line, rounds the allotted beach turning marker and returns to the IRB. The driver may also assist the crewperson and patient to turn the IRB around. The patient may

assist with relaunching the IRB but must release contact and move safely clear as the engine propels the IRB forward or prior to if safe to do so.

**Note:** The patient must then place themselves in a position where they do not impede the conduct of the race or judging of the event.

- G. The IRB shall be relaunched and restarted, and the crew will proceed out to sea to pick up their second patient and then return to shore, as described in S7-3.4 and S7-3.5.
- H. The finish shall be as described in S7-3.6.

## 6. IRB TEAMS RESCUE

- A. Each team shall comprise of two drivers, two crewpersons and two patients.

**Note:** In National Teams Inflatable Rescue Boat Lifesaving World Championships, the IRB Teams Rescue event is a mixed event. Teams shall consist of one female crew (driver, crewpersons, and patients) and one male crew (driver, two crewperson and patient) competing in that order.

- B. The patients are positioned as described in S7-3.1.
- C. The start shall be as described in S7-3.2 and S7-3.3.
- D. The second driver and second crewperson shall position themselves with their feet on or behind the changeover line.
- E. The crew shall proceed out to sea, pick up their first patient and then return to shore, as described in S7-3.4 and S7-3.5.
- F. The driver, crewperson and patient shall exit the IRB as described in S7-3.6. The second crewperson crosses the changeover line and proceeds to the IRB once the driver has left the IRB.
- G. The first crewperson turns the IRB and must maintain control of it as described in S7-3.7A. The patient or the first crewperson is permitted to assist the second crewperson to hold, turn, and relaunch the IRB. It is also permitted for the boat to be placed at an angle to assist driver entry if it is safe to do so.

**Note:** Unless otherwise permitted by the Chief Referee a maximum of two team members plus the driver are permitted to maintain contact (control) with the IRB at any one time.

- H. After the tag, the second driver proceeds to the water's edge to relaunch and restart the IRB. The first crewperson or patient at their discretion may continue to assist with relaunching the IRB after the second driver has made contact with the IRB but must release contact and move safely clear as the engine propels the IRB forward or prior to if safe to do so.

**Note:** The first crewperson and first patient must place themselves in a position where they do not impede the conduct of the race or judging of the event.

- I. The second crew will proceed out to sea, pick up their second patient and then return to shore, as described in S7-3.4 and S7-3.5.
- J. The finish shall be as described in S7-3.6.

## 7. IRB RESCUE TUBE

- A. Each team shall comprise one driver, one crewperson and one patient.
- B. The patient is positioned as described in S7-3.1.
- C. For this event only, the rescue tube (excluding the lanyard/harness and rope) is to be stored under the spray dodger at the start of the event. No adjustments are permitted to be made to the rescue tube.
- D. The start shall be as described in S7-3.2 and S7-3.3.
- E. Following the start and while maintaining a secure position, the crewperson shall don the rescue tube lanyard/harness in a safe manner prior to rounding the buoy.
- F. The IRB shall round the turning buoy anticlockwise and then must remain wholly, i.e., all parts of the IRB, on the beach side of the turning buoy until the patient pick-up has commenced (see S7-7K).
- G. After the IRB has rounded the turning buoy, the crewperson shall leave the IRB from the shoreward side of the buoy. The rescue tube shall be unclipped and held by the crewperson as they exit the IRB.
- H. The crewperson shall then swim to their patient at their respective rescue tube patient buoy by the most direct route and then round the buoy in an anticlockwise manner to collect their patient.

**Note:** The crewperson may pass by either side of the patient pick up buoy (used for events other than the IRB Rescue Tube Race) to reach their patient.

- 
- I. The rescue tube must then be fastened around the patient and under both arms by the crewperson and/or patient. The patient may clip themselves into the rescue tube unaided. The crewperson does not have to break stroke during this process as long as the clip on the rescue tube is secured to an O-ring prior to the patient pick up commencing.
  - J. The crewperson completes their 180 degrees anticlockwise turn around the buoy and tows the patient to the IRB maintaining the turning buoy on their left-hand side. The patient is permitted to assist by kicking, and sculling with arms under the surface, but must not swim with an out-of-water arm recovery. The patient must not be towed on their stomach (abdomen). The use of swim fins, hand fins or other non-approved aids are not permitted.
  - K. Once the crewperson or patient has made contact with the IRB, the patient pickup is deemed to have commenced, and the IRB may cross to the seaward side of the turning buoy.
  - L. The crewperson and patient shall board the IRB on the port side with or without assistance from the driver. The driver may release the motor throttle grip and stand to assist the pick-up providing the motor is in neutral.

**Note:** The crewperson is permitted to enter the boat before the patient or vice versa.

- M. The IRB shall continue anticlockwise around the turning buoy.
- N. The rescue tube shall remain around the patient and the crewperson shall remove the lanyard/harness and pass it to the patient. The patient must then keep a secure grip on the lanyard/harness and rope/line until the driver exits the IRB to ensure that it does not snag anything within the IRB or extend past the transom or pass through either of the self-bailers.

**Note:** There is no requirement for the patient to hold up their hand with the lanyard/harness and rope/line at the completion of the race for judge notation purposes.

- O. The crew shall return to shore as described in S7-3.5.
- P. The finish shall be as described in S7-3.6.

## **8. DISQUALIFICATION**

Crews shall be disqualified if found to have failed to comply with any event procedures, descriptions, rules, and/or other matters contained in the ILS Competition Rule Book or relevant circulars or bulletins. Safety and technical disqualifications for IRB competition are in the disqualification codes in this section.

## 9. DISQUALIFICATION CODES FOR IRB EVENTS

### A. General Disqualifications

Code and Disqualification	Events
A1 - Not competing in accordance with the general rules.	All events
A2 - A competitor or team may be disqualified if a competitor, team, or handler is deemed to have competed unfairly. Examples of “competing unfairly” include: <ul style="list-style-type: none"> <li>• Committing a doping or doping-related infraction.</li> <li>• Impersonating another competitor.</li> <li>• Attempting to defeat the ballot or draw for events or positions.</li> <li>• Team competing twice in the same event.</li> <li>• Individual competing twice in the same event in different teams.</li> <li>• Purposely interfering with a course to gain advantage.</li> <li>• Jostling or obstructing another competitor or handler so as to impede their progress.</li> <li>• Receiving physical or material outside assistance (other than verbal or other direction).</li> <li>• Participating contrary to the spirit of the competition (as described in the code of fair play).</li> </ul>	All events
A3 - Competitors may not be permitted to start in an event if they are late reporting to the Marshalling Area. This may be noted as a “did not start” (DNS) or similar on the result sheet.	All events
A4 - A competitor or team absent from the start of an event shall be disqualified. This may be noted as a “did not start” (DNS) or similar on the result sheet.	All events
A5 - Activities that result in wilful damage to the venue sites, accommodation sites or the property of others will result in disqualification of the individuals involved from competition.	All events
A6 - Abuse of Officials may result in disqualification from the competition.	All events
A7 - Failing to comply with the starter’s commands within a reasonable time.	All events
A8 - A competitor who, after the starter’s first command, disturbing others in the race through sound or otherwise may be disqualified.	All events

### B. Technical and Safety Disqualification Codes

TDQ—Technical Disqualification

SDQ – Safety Disqualification

B. START	DQ Type
B1 – Driver or crewperson false starts.	TDQ
B2 – IRB not positioned as directed and/or not in front of crews’ finish markers.	TDQ
B3 – Bow of IRB not facing towards the wave line at start of event. <b>Note:</b> Angling the IRB to assist driver and/or crewperson entry is permitted.	TDQ
B4 – Handler assists crew to launch IRB once the boat is propelled forward by the motor.	TDQ
B5 – Driver starts motor outside of IRB.	SDQ
B6 – Driver using two-handed start and motor not in neutral.	TDQ
B7 – Driver starts motor when crewperson not in contact with IRB.	TDQ
B8 – During or immediately after the start, the IRB moving in an uncontrolled or unsafe fashion.	SDQ
B9 – Driver pushes or pulls the IRB while motor is in gear and motor running.	SDQ

C. PROCEEDING TO AND FROM BUOYS	DQ Type
C1 – General driving and/or crewing techniques that lead to a crew person (and/or patient) being dislodged from their normal position within the IRB.	SDQ
C2 – Punching a wave in a dangerous manner or causing the driver or crewperson to be dislodged.	SDQ
C3 – IRB turning around “incorrect buoy or buoys”.	TDQ
C4 – IRB turn at the turning buoy not being initiated from the port (left hand) side of the IRB. <b>Note:</b> It is not judged if the buoy is forced under the pontoon provided that the turn is correctly initiated.	TDQ
C5 – Leading IRB has right of way; trailing IRB(s) did not take evasive action.	SDQ
C6 – Crew steering a wide course or IRB delaying a turn so as to impede or force another IRB out of its true course.	TDQ
C7 – Crewperson or patient losing contact with the IRB during the course of an event.	SDQ
C8 – Loss of control by the driver and/or crewperson even if still in contact with the IRB.	SDQ
C9 – IRB not completing the course as defined for that event.	TDQ
C10 – IRB not completing a 360° turn around the allocated IRB turning buoy.	TDQ
C11 – Returning to shore, coming down a wave in a dangerous manner and/or causing the driver and/or crewperson and/or patient to be dislodged.	SDQ

D. PATIENT PICK-UP	DQ Type
D1 – Patient pick-up not commenced on seaward side of patient buoy.	TDQ
D2 – Patient not picked up on the port side of the IRB.	TDQ
D3 – Driver, crewperson or patient losing contact with IRB.	SDQ
D4 – Patient not picked up in a safe manner (i.e., patient pick-up not completed as prescribed in the rules).	SDQ
D5 – IRB passes around incorrect turning or patient pick-up buoy.	TDQ
D6 - The IRB turn at the patient pick-up buoy not being initiated from the port (left hand) side of the IRB. <b>Note:</b> It is not judged if the buoy is forced under the pontoon provided that the turn is correctly initiated.	TDQ
D7 – IRB passes around turning or patient pick-up buoy in a clockwise (right hand in) direction.	TDQ
D8 – After missing patient pick-up, IRB did not complete a 180° turn around IRB turning buoy before reattempting patient pick-up at patient buoy.	TDQ
D9 – Driver and/or crewperson failing to assist with the patient lift into the IRB.	TDQ

E. IRB RESCUE TUBE EVENT	DQ Type
E1 – IRB not rounding its turning buoy before crewperson leaves the IRB (to enter the water).	TDQ
E2 – Crewperson not leaving the IRB in the correct manner.	TDQ
E3 – Crewperson has rescue tube clipped up before reaching patient.	TDQ
E4 – Crewperson/patient not swimming anticlockwise around their respective buoy.	TDQ
E5 – Patient not clipped into ‘O’ rings on rescue tube before the patient pick up commences at the IRB.	TDQ
E6 – Patient floating on stomach or using arm action above the water while being towed.	TDQ

<b>E. IRB RESCUE TUBE EVENT</b>	<b>DQ Type</b>
E7 – IRB not remaining on beach side of the turning buoys until patient or crewperson has made contact with the IRB.	TDQ
E8 – Crewperson/patient not boarding IRB on the port side.	TDQ
E9 – IRB not completing an anticlockwise turn around the turning buoy after pick-up.	TDQ
E10 – Patient not having the rescue tube clipped around waist and/or having the lanyard/harness and rope/line secured at the finish of the rescue tube event.	TDQ

<b>F. CHANGEOVER – IRB MASS/TEAMS</b>	<b>DQ Type</b>
F1 – Driver leaving IRB with motor running (i.e., does not activate engine kill switch).	TDQ
F2 – Driver(s) and/or crewperson and/or patient not completing the changeover as defined for the event.	TDQ
F3 – Patient leaves IRB before the IRB motor is stopped.	TDQ
F4 – Driver(s) and/or crewperson or patient not completing changeover as defined for the event.	TDQ

<b>G. FINISH</b>	<b>DQ Type</b>
G1– Driver leaves IRB with motor running (i.e., does not activate engine kill switch).	TDQ
G2 – Driver exits IRB incorrectly.	TDQ
G3 – Driver beaches IRB out of their respective lane as defined.	TDQ
G4 – Crewperson leaves IRB before the IRB motor is stopped.	TDQ
G5 – Patient(s) leaves IRB before the IRB motor is stopped and driver has exited the IRB.	TDQ
G6 – Driver fails to cross the finish line on their feet.	TDQ

<b>H. GENERAL</b>	<b>DQ Type</b>
H1 – Driver acting in an unsafe manner.	SDQ
H2 – Crewperson acting in an unsafe manner.	SDQ
H3 – Patient acting in an unsafe manner.	SDQ
H4 – Crewperson losing the bow rope.	SDQ



**World Water Safety  
INTERNATIONAL LIFE SAVING FEDERATION**

## **ILS COMPETITION RULE BOOK**

### **SECTION 8 FACILITY AND EQUIPMENT STANDARDS**



**2025 EDITION**  
**(Revised May 2026)**

## SECTION 8 FACILITY AND EQUIPMENT STANDARDS AND SCRUTINEERING PROCEDURES

### 1. POOL FACILITY STANDARDS

Lifesaving World Championships shall be conducted in an eight-lane (minimum) 50m swimming pool which complies with ILS standards. Facility measurements must be certified by a person appointed or approved by the ILS Management Committee.

#### 1.1 Scrutineering procedure

- A. For ILS-managed events (e.g., Lifesaving World Championships, World Games), a person appointed by the Organising Committee shall review a pool survey certificate (or similar) that specifies pool length, width, depths, lane widths and ropes, starting platforms, electronic timing equipment, etc.
- B. In the absence of such a certificate, the person appointed by the ILS Management Committee shall check that the pool facility meets ILS facility standards. In addition, the following equipment shall be checked:
  - Obstacles, rescue tubes, throw lines, manikins.
  - Manikin platforms (including a depth check to ensure the platform is not too shallow).
- C. Minimum measuring equipment required: tape measure (minimum 50m with 1mm increments; depth rod or pole).
- D. For ILS-sanctioned events, the sanction application requires a declaration from the competition Organisers that the pool and all equipment to be used in the competition meets ILS standards.

#### 1.2 Length

The pool shall be 50m between the automatic officiating equipment touch panels at the starting end and the wall or touch panels at the turning end. A tolerance of plus 30mm and minus 0.00mm in each lane is allowed.

#### 1.3 Lanes

There shall be a minimum of eight lanes that shall be at least 2.5m wide, with two spaces of at least 200mm outside the first and last lanes. There shall be lane ropes on both sides of each lane that extend the full length of the course. Each lane rope will consist of floats placed end-to-end having a minimum diameter of 50mm to a maximum of 150mm. The lane ropes shall be firmly stretched.

#### 1.4 Starting platform

The height of the platform above the water surface shall be from 500mm to 750mm. The surface area shall be at least 500mm x 500mm and covered with non-slip material. The maximum slope shall not be more than 10 degrees. The starting platform may have an adjustable setting back plate and starting grips for both platform and in-water starts. If necessary, any exposed ends on starting grips, etc. should be covered.

#### 1.5 Automatic officiating equipment

The pool shall be equipped with automatic officiating equipment to record the time of each competitor and to determine the place of each competitor in race events.

#### 1.6 Water

The pool water shall meet the clarity standards and the bacteriological and chemical standards of the applicable local health regulations in the host nation. The water temperature shall be 25°C to 28°C.

#### 1.7 Depth

For each event conducted, the pool shall comply with ILS event-specific depth standards. Except as specified in event-specific standards, a minimum depth of 1m is required.

**Note:** When surveying a pool for sanctioning of an ILS competition, a check is also to be undertaken of the pool floor and other design features that may render the pool non-compliant for one or more events (e.g. a ledge or other fixtures that could be used to push off from the pool floor). Such non-compliances should be recorded, and a specific notation made if records cannot be established/recognised for particular events. Competitors and teams are to be advised of any events in which records cannot be set as part of the entry process.

### 1.8 Dive start

Minimum depth of 1.35m extending from 1m to at least 6m from the starting end wall.

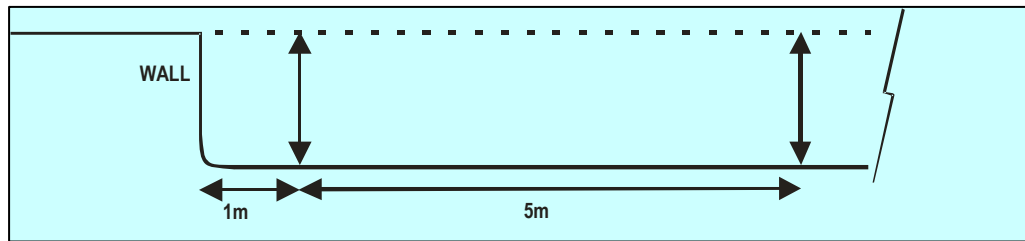

### 1.9 Obstacle Swim, Obstacle Relay

Minimum depth of 1.8m extending from 2m on both sides of any obstacle.

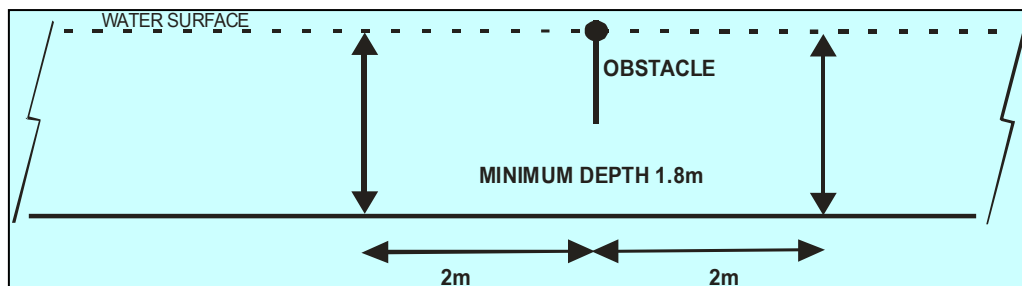

### 1.10 Manikin Carry (50m), Super Lifesaver (200m)

- A. Minimum depth of 1.8m extending at least 2m beyond the 24m mark from the wall.
- B. Manikins are placed on the pool bottom to a maximum depth of 3m. In pools deeper than 3m, “platforms” may be used to hold manikins at the 3.0m depth.

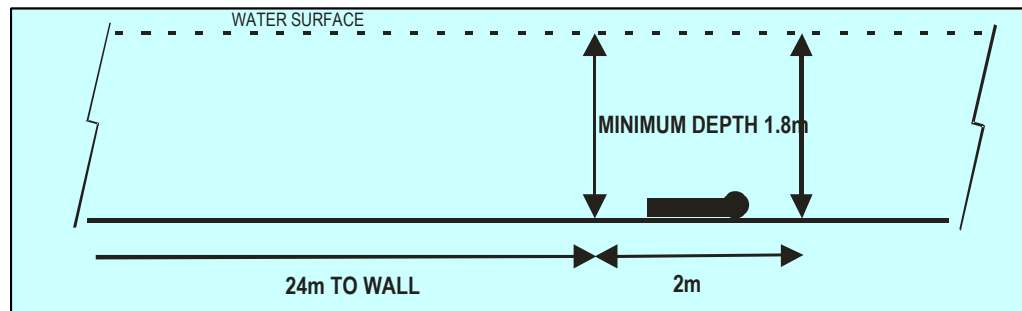

**1.11 Manikin Carry with Fins (100m), Manikin Tow with Fins (100m), Super Lifesaver (200m), Pool Lifesaver Relay (4 x 50m)**

- A. Minimum depth of 1.8m extending at least 2m from the turn wall.
- B. Manikins are placed on the pool bottom to a maximum depth of 3m. In pools deeper than 3m, “platforms” may be used to hold manikins at the 3m depth.
- C. In the Manikin Carry with Fins event, the manikin shall be positioned on its back in contact with the pool bottom and its base touching the pool wall, with its head in the direction of the finish.
- D. Where the facility design does not provide a vertical wall that joins the bottom at 90 degrees, the manikin must be positioned as close as possible to the wall, but no further than 300mm from the wall as measured at the water surface.

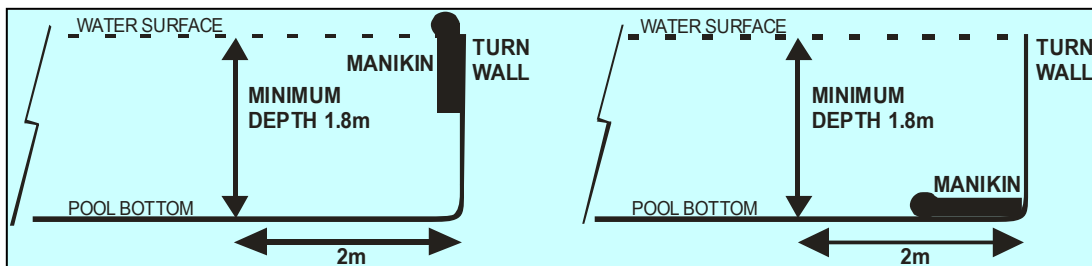

**1.12 Rescue Medley (100m)**

- A. Minimum depth of 1.8m extending at least 2m beyond the 16.5m mark from the turn wall.
- B. Manikins are placed on the pool bottom to a maximum depth of 3m. In pools deeper than 3m, “platforms” may be used to hold manikins at the 3m depth.

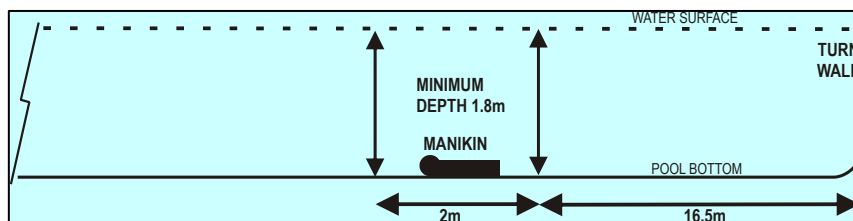

**1.13 Manikin Relay (4 x 25m)**

- A. Minimum depth of 1.8m extending at least 2m on both sides of the 25m exchange mark at centre pool.
- B. Minimum depth of 1m at the starting end wall.
- C. Minimum depth of 1.8 m extending at least 2m from the turn wall.

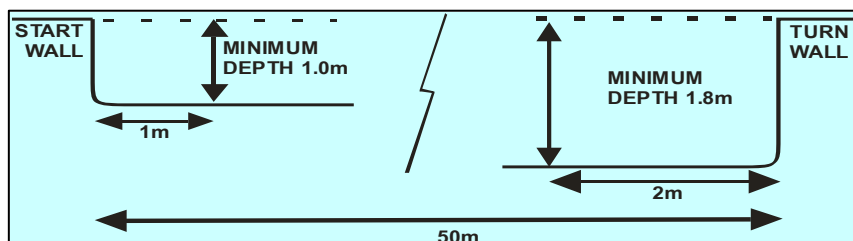

### 1.14 Medley Relay (4 x 50m)

- Minimum depth of 1.35m, extending from 1m to at least 6m from the starting end wall.
- Minimum depth of 1.8m, extending at least 2m from the turn wall.

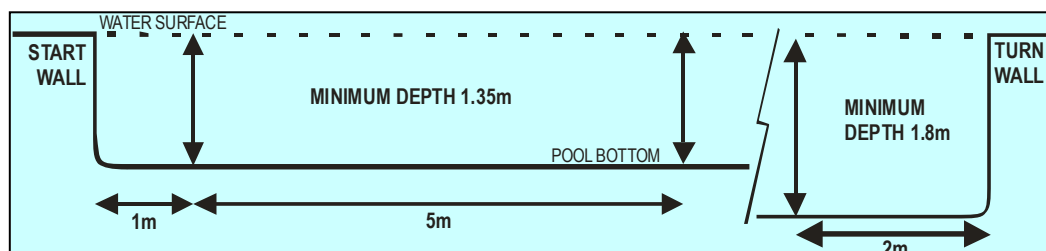

### 1.15 Line Throw

- Minimum depth of 1.8m extending at least 2m from the rigid crossbar.
- The rigid crossbar is positioned on the surface across each lane 12.5m from the starting end of the pool. A tolerance of plus 100mm and minus 0.00mm in each lane is allowed.

### 1.16 Simulated Emergency Response Competition (SERC)

SERC may be conducted in the eight-lane 50m pool or in a facility of another design, as approved by the Organising Committee for a competition.

## 2. GENERAL ILS EQUIPMENT STANDARDS

The ILS has adopted the following equipment specifications. Where appropriate, allowable tolerances are recorded – for example “(± 200mm)” meaning a tolerance of plus 200mm and minus 200mm is allowed. Where appropriate, dimensions and weights are recorded as “minimum” or “maximum” allowed.

In addition, all equipment used in Lifesaving World Championships must comply with the criteria outlined in the commercial identification policy in the Championships handbook.

### Scrutineering of equipment

Competition bulletins/circulars/handbooks shall detail the procedures for checking equipment. The Organising Committee reserves the right to re-inspect competition equipment at any time during the Championships. Equipment found to contravene ILS specifications shall be subject to disqualification, which may result in the disqualification of the competitor using the equipment and the possible disqualification of the full team.

Protests and appeals against rulings of personal equipment ineligibility are permitted.

Some equipment may require detailed specification and testing in advance of the competition due to design features and the nature of the measurement equipment required. Surf skis, boards, IRBs, surf boats and manikins have additional specifications that can be referenced through the ILS at [www.ilsf.org](http://www.ilsf.org).

## 3. POOL EQUIPMENT STANDARDS

### 3.1 Rescue Manikins

#### General

The first Manikins were constructed by the founder of FIS, Mr Raymond Pitet.

For Lifesaving World Championships, Regional Championships, World Games, and ILS managed or sanctioned events the only manikins that shall be used are those assessed and approved by the ILS. The ILS maintains a list of approved competition manikins. The ILS approved competition manikins include the:

- German (DLRG) Manikin.
- Canadian (LSC) Manikin.
- Australian (SLSA) Manikin.
- Wetiz Manikin.

#### Construction and composition

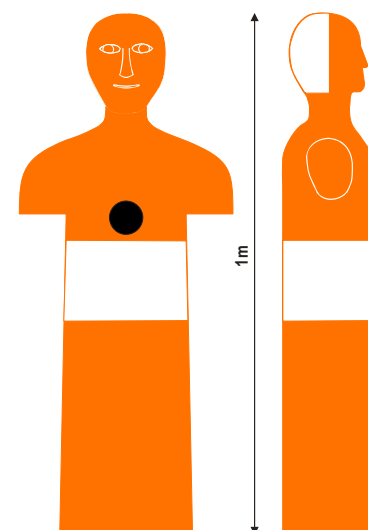

- Manikins are constructed from polyethylene and once moulded, are characterised by a high level of stiffness to stay in shape for competition.
- Manikins must be hermetic (i.e., capable of being filled with water and sealed for competition).
- Material: Polyethylene.
- Colour: Orange.
- Transverse line: must be of contrasting colour with the rest of the manikin and water.
- Thickness: 944 kg/m<sup>2</sup>.
- Fluidity Index: 3.0 dg/min.

#### **Mechanical properties of materials**

- Coefficient of Elasticity: 1000 N/mm<sup>2</sup>.
- Shock resistance Izod at +23°C: 19 Kj/m<sup>2</sup>.
- Shock resistance Izod at -20°C: 6 Kj/m<sup>2</sup>.
- Breaking resistance (ESCR) at 60°C and 2N/mm<sup>2</sup>: 40h.
- Traction resistance at 50mm/min: 31 N/mm<sup>2</sup>.
- Break point in lengthening at 50mm/min: >500%.
- Hardness Shore D: 57.
- Vicat point of softening: 121°C.
- Fusion temperature: 128°C.

#### **Technical measurement and weight specification (refer 8.2 for scrutineering detail)**

- Total height: 1000mm (variance: 980-1000mm, 2% variance).
- Height under armpit: 595mm (permitted variance: 1.7% or 585-595mm).
- Height transition line: 550mm (permitted variance: 1.9% or 540-550mm).
- Width at base: 260mm (permitted variance: 4% or 250-260mm).
- Depth at base: 200mm (permitted variance: 5.3% or 190-200mm).
- Circumference of head at eyes: 590mm (permitted variance: 3.5% or 570-590mm).
- Circumference of breast under arms: 800mm (permitted variance: 2.6% or 780-800mm).
- Circumference of base 1 cm from bottom: 840mm (permitted variance: 2.4% or 820-840mm).
- Weight in water completely submerged: 1500 g (1450-1500 g, 3.4% variance).

#### **Physical features**

- The manikin must resemble a human and possess anthropological features that are required for rescue and resuscitation. The head requires the following features: eyes, nose, mouth, chin, jaw, and throat. The body requires a chest, torso arm buds, abdomen, and pelvis.
- For events in which the manikin is recovered from the bottom, the manikin needs to rest on its back at 2m depth without moving. The manikin needs to be able to rest in this position for a period of 4 hours without leaking water or air. If the manikin has filling holes and plugs, these should be located for ease of filling and emptying and be water and airtight. The manikin weight should be located such that it keeps the manikin positioned on its back.
- The manikin needs to be able to float at the transition line for use in manikin towing events.

#### **Scrutineering procedure**

- A person appointed by the Organising Committee shall check the approved manikin. Minimum measuring equipment required: tape measure (minimum 10m with 1mm increments); weigh scale (minimum 50 kg capacity with 0.01kg increments).
- For ILS LWC or sanctioned events, a declaration from the competition Organisers is required that all pooled rescue manikins to be used in the competition will meet ILS standards.

### **3.2 Obstacles**

- Dimensions: Obstacles used in pool events shall be 700mm (± 10mm) high and 2.4m (± 30mm) wide with no dangerous parts.
- Inner frame: The inner frame shall consist of a net or other element which does not permit passage by a swimmer, and which is of a bright colour that contrasts with the water and is clearly visible.
- Upper line: The upper line of the obstacle is placed on the water level and shall be clearly visible. Use of an additional floating line across the upper line of the obstacles is recommended.

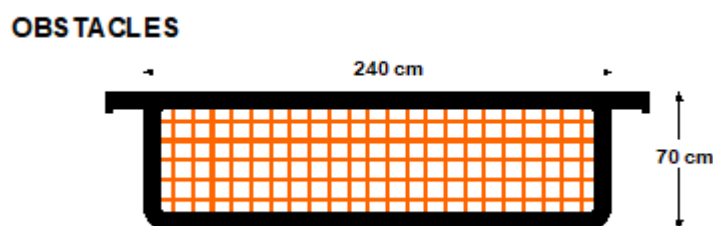

### Scrutineering procedure

- A person appointed by the Organising Committee shall check the obstacles. Minimum measuring equipment required: tape measure (minimum 10m with 1mm increments).
- For ILS-sanctioned events, the sanction application requires a declaration from the competition Organisers that all obstacles to be used in the competition will meet ILS standards.

### 3.3 Rescue Tubes

The ILS has used a range of rescue tubes in Lifesaving World Championships including the:

- Australian (SLSA and RLSSA) Rescue Tubes.
- Canadian (LSC) Rescue Tubes
- Wetiz Rescue Tubes

**Note:** Rescue Tubes are assessed individually for each Lifesaving World Championships and for ILS sanctioned events and other tubes may be used.

#### Construction and composition

- Source of buoyancy: Material to be as specified in Australian Standard AS2259 or equivalent. The material shall be closed cell plastic foam, and durable and flexible.
- Buoyancy: The rescue tube shall have a minimum buoyancy factor of 100 newtons in fresh water.
- Flexibility: The body of the rescue tube shall be of such a nature as to be able to roll within itself with a force of 5-6 kg.
- Strength: Webbing, leash, and fittings shall be able to withstand a minimum of 454.55 kg (1000 lb.) stress in a longitudinal direction without damage.
- Weight: Total weight of the tube should be between 600-750 g.
- Colour: The body of the rescue tube shall be a colour-fast red, yellow, or orange (impregnated, painted, or covered) as per Australian Standard AS1318.
- Stitching/thread: Stitching shall be a locked stitched type 301 of British Standard BS 3870 as illustrated in Australian Standard AS2259. The thread is to have similar properties to the materials being sewn.

#### Technical measurements specification

- A. Rescue Tube Dimensions: The body of the tube (flotation component):
  - Length: Minimum length 875mm; maximum length 1000mm.
  - Breadth: Maximum breadth 150mm.
  - Thickness: Maximum thickness 100mm.
  - The distance from the extremity of the clip to the extremity of the second O-ring shall be a minimum of 1.30m to a maximum of 1.65m.
- B. Leash/line: The length of the leash from the first O-ring to the lanyard webbing shall be a minimum of 1.90m to a maximum of 2.10m and must include a minimum of 2 O-rings. The leash shall be a synthetic type of rope which is UV treated.
- C. Webbing connections: Webbing used for the connection of O-rings/clips to the body of the tube shall be 25mm ( $\pm$  2.5mm) wide woven nylon.
- D. Lanyard/harness: Webbing for the lanyard shall be 50mm ( $\pm$  5.0mm) wide woven nylon with a minimum length of 1.30m to a maximum of 1.60m. The circumference of the lanyard/harness loop shall be a minimum of 1.20m.

- E. O-rings: O-rings shall be brass, stainless steel (welded) or nylon. If nylon, the rings shall be UV treated. O-rings shall be 37.5mm (± 10.0mm) internal diameter, having no sharp edges or protrusions that may cut or injure the rescuer or victim.
- F. Clips: The clip shall be a brass or stainless-steel snap hook KS2470-70 with an overall length of 70mm (± 7.0mm). It shall have no sharp edges or protrusions that may cut or injure the rescuer or victim.
- G. Overall length: The distance from the clip to the end of the lanyard/harness shall be a minimum of 3.65m to a maximum of 4.30m.

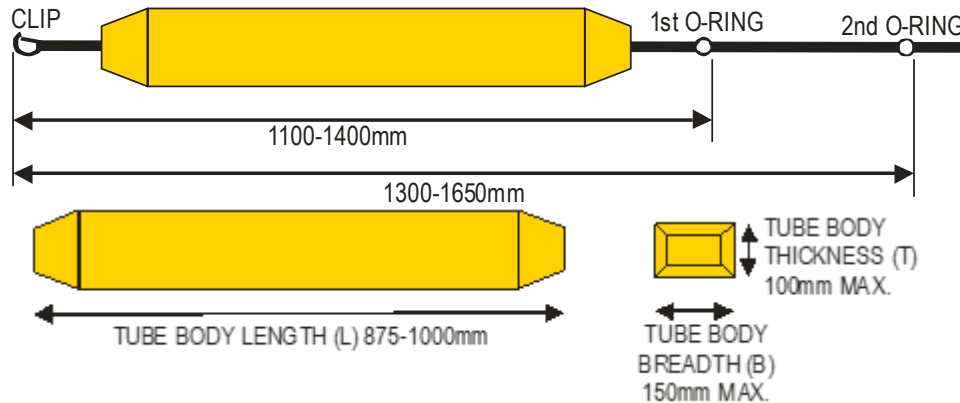

**Total Length: Clip to End of Lanyard/Harness: 3.65m - 4.30m.**

**Scrutineering procedure**

- A person appointed by the Organising Committee shall check the rescue tubes. Minimum measuring equipment required: tape measure (minimum 10m with 1mm increments).
- For ILS LWC or sanctioned events, a declaration from the competition Organisers is required that all pooled rescue tubes to be used in the competition will meet ILS standards.

**3.4 Swim Fins**

Fins are measured while not worn. Swim fins used in competitions shall comply with the following specifications:

- Length: maximum overall length 650mm, including ‘shoe’ or ankle strap (ankle strap extended).
- Width: 300mm maximum at the widest point of the blade

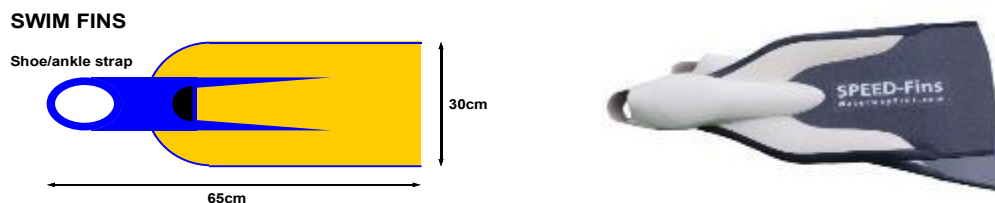

**Scrutineering procedure**

- A person appointed by the Organising Committee shall check the fins at the pool and/or beach. Minimum measuring equipment required: tape measure (minimum 10m with 1mm increments),

or a fin box in which the fins are fully inserted, or another measurement tool for quick and efficient measurement.

- The Organising Committee shall provide a stamp or sticker to be affixed to the fins as proof of the scrutineering check.
- A similar process shall be undertaken for ILS LWC and sanctioned events.

### 3.5 Throw Lines

For the Line Throw event, throw lines shall be plaited, buoyant polypropylene with non-memory characteristics:

- Diameter: 8mm ( $\pm$  1mm).
- Length: minimum 16.5m; maximum 17.5m.

#### **Scrutineering procedure**

- A. A person appointed by the Organising Committee shall check the throw lines. Minimum measuring equipment required: tape measure (minimum 20m with 1mm increments).
- B. For ILS LWC or sanctioned events, a declaration from the competition Organisers is required that all pooled throw lines to be used in the competition will meet ILS standards.

## 4. BEACH/OCEAN EQUIPMENT STANDARDS

### 4.1 Rescue Tubes

See S8-3.3.

### 4.2 Swim fins

See S8-3.4.

### 4.3 Batons (Beach Flags and Beach Relay)

Beach flag batons and beach relay batons shall be approximately 250mm to 300mm long with an external diameter of approximately 25mm to 40mm and made of flexible material (e.g., flexible hose). Batons should be coloured so as to be easily visible.

#### **Scrutineering procedure**

- A person appointed by the Organising Committee shall check the batons. Minimum measuring equipment required: tape measure (minimum 1m with 1mm increments).
- For ILS LWC or sanctioned events, a declaration from the competition Organisers is required that all beach flag batons to be used in the competition will meet ILS standards.

### 4.4 Surf Boards

Surf boards must conform to ILS specifications including the following:

- Weight: minimum 7.6kg\*
- Length: maximum 3.2m

**Video camera:** If a camera is mounted on the board, it must be installed on a mounting device and toggle strap supplied or recommended by the manufacturer of the device. The camera shall be mounted anywhere from the hand grips closest to the nose to the nose of the craft.

\* The weight of any plugs permanently installed into the craft to attach the camera is included in the overall weight of the craft. The weight of other, non-permanently installed mount and camera are not included in the overall weight.

Detailed specifications for surf boards are described in a separate document located at <https://www.ilsf.org/lifesaving-sport/rules/irb-specification/>.

#### **Scrutineering procedure**

- When Boards are scrutineered craft shall be checked for maximum length, minimum weight, and safety (e.g., state of repair). Minimum measuring equipment required: tape measure, minimum 10m with 1mm increments; weigh scale with minimum 10kg capacity with 0.01kg increments. Also recommended is a measuring “jig” to measure length and testing gauges to measure nose diameters and minimum fin width and thickness.
- The host Organising Committee shall provide a stamp or sticker to be affixed to each craft as proof of the scrutineering check.
- For ILS LWC or sanctioned events, a declaration from the competition Organisers is required that all pooled boards to be used in the competition will meet ILS standards.

- Any other scrutineering determined by the competition Organisers.

**Note:** If a surf board is found to be underweight at scrutineering prior to competition, the organiser may allow for weight to be replaced with an approved material provided the material is properly fixed to the craft e.g. Thermoset resin or other approved method such as certified lead weights glued to the deck of the craft. The craft cannot be used in lifesaving competition until the weight is brought up to the correct weight specification.

#### 4.5 Inflatable Rescue Boats (IRB)

Inflatable rescue boats and motors shall meet the specifications of the ILS and the host country and be supplied by the host organising committee. The Organising Committee shall make IRB boat and motor specifications available to teams well in advance of the competition.

**Video camera:** If a camera is mounted on the IRB, it must be installed on a mounting device and toggle strap supplied or recommended by the manufacturer of the device. The camera may only be mounted on the transom or on the cowling of the motor.

Detailed specifications for IRBs are described in a separate document located at:

<https://www.ilsf.org/lifesaving-sport/rules/irb-specification/>.

#### 4.6 Personal Flotation Devices (PFDs)

IRB event competitors (drivers, crewpersons, and patients) must wear solid PFDs (lifejackets) that comply with the international standard – ISO12402-5 Level 50 or equivalent. Inflatable PFDs (lifejackets) cannot be worn in lieu of a solid PFD (lifejacket).

The wearing of PFDs is optional in other craft events. It is highly recommended that the PFDs worn by competitors comply with an international standard or equivalent. (e.g., AS4758 L25 flotation)

In cases where the device does not meet the standard, the wearer is encouraged to complete a risk assessment and read all relevant safety and operational instructions on the product. Not all PFDs meet standards and thus their effectiveness in preventing drowning is unproven. Non-compliance with the International Standard may mean that these devices present other potential risks (e.g., poor fit, easily dislodged in surf conditions and restricted movement and breathing).

##### **Scrutineering procedure**

- A person appointed by the Organising Committee shall check that pooled PFDs meet ILS specifications. A person appointed by Organising Committee shall check the competitor provided PFDs.
- For ILS LWC or sanctioned events, a declaration from the competition Organisers is required that all pooled PFDs to be used in the competition will meet ILS standards.

#### 4.7 Helmets

Approved aquatic helmets are EN 1385 certified (or equivalent). Helmets may be in the manufacturer's original colour, or preferably, painted (provided that the helmets performance is not compromised) or covered in material in accordance with competitors' team/competition caps.

##### **Scrutineering procedure**

- A person appointed by the Organising Committee shall check that pooled helmets meet ILS specifications. A person appointed by the Organising Committee shall check the competitor provided helmets.
- For ILS LWC or sanctioned events, a declaration from the competition Organisers is required that all pooled helmets to be used in the competition will meet ILS standards.

#### 4.8 Wetsuits

Wetsuits may be either full and extend from the neck to the wrists and ankles or can be briefer. With the exception of IRB events, wetsuits worn in swimming events or swimming legs of events shall have a maximum thickness of 5mm at any location on the wetsuit with a tolerance of  $\pm 0.5$ mm. There is no maximum thickness for wetsuits worn in IRB events or non-swimming events.

##### **Scrutineering procedure**

- A person appointed by the Organising Committee shall check the water temperature and wetsuits.
- All wetsuits are subject to random scrutineering. Minimum measuring equipment required: thermometer (minimum 10°C with 0.5°C increments); micrometre.

- A similar process shall be undertaken for ILS-sanctioned event.

#### 4.9 Surf Boats

Surf boats must conform to ILS specifications including the following:

- Weight: minimum 180kg (excluding oars, rowlocks, rescue tube and all optional equipment)  
**Note:** The minimum racing weight for a surfboat is 200 kilograms, including the seats, pumps, and foot blocks. This excludes rowlocks, oars, batteries, and any other additions.
- Length: minimum 6.86m; maximum 7.925m (excluding outrigger)
- Beam: minimum 1.62m (measured in the midship section)

**Video camera:** If a camera is mounted on the surf boat it must be installed on a mounting device and toggle strap supplied or recommended by the manufacturer of the device.

The camera may be mounted on the splash board (front deck), or on the tanks opposite the rowers' seat, and on the rear deck.

\* The weight of any plugs permanently installed into the boat to attach the camera is included in the overall weight of the craft. The weight of other, non-permanently installed mount and camera are not included in the overall weight.

Detailed specifications for surf boats are described in a separate document located at

<https://www.ilsf.org/lifesaving-sport/rules/irb-specification/>.

#### Scrutineering procedure

- When scrutineered boats shall at a minimum, be checked for weight and safety (e.g., state of repair). Oars shall also be checked for competitor safety. Minimum measuring equipment required: tape measure, minimum 10m with 1mm increments; weigh scale with minimum 200kg capacity with 0.1kg increments.
- The host Organising Committee shall provide a stamp or sticker to be affixed to each boat as proof of the scrutineering check.
- For ILS LWC or sanctioned events, a declaration from the competition Organisers is required that all pooled boats to be used in the competition will meet ILS standards.
- Any other scrutineering determined by the competition Organisers.

**Note:** If a surf boat is found to be underweight at scrutineering prior to competition, the organiser may allow for weight to be replaced with an approved material provided the material is properly fixed to the craft e.g. Thermoset resin or other approved method such as certified lead weights glued to the deck of the craft. The craft cannot be used in lifesaving competition until the weight is brought up to the correct weight specification.

#### 4.10 Buoys and Flags

**Ocean event Buoys:** The buoys used in ocean events shall be of distinctive colours, and, with the first buoy being number one (looking from the left, facing the water). The buoys and colours are described in the rules for the various ocean events in this Rule Book. For the straight line of buoys used in particular events the colours are:

- Buoy 1: Red and Yellow halves
- Buoy 2: Black
- Buoy 3: Green with a White stripe
- Buoy 4: Red
- Buoy 5: Blue with a White stripe
- Buoy 6: Yellow
- Buoy 7: White with a Black stripe
- Buoy 8: Orange
- Buoy 9: Green and Yellow Halves

When these buoys are used for the Surf Race, Surf Teams Race, Rescue Tube Rescue, Rescue Tube Race, Board Rescue, Oceanman/Oceanwoman, Oceanman/Oceanwoman Relay races they must be affixed to the buoy line on both ends of the buoy so that they float horizontally in the water and are of equal distance from the beach.

When the buoys are used for the Surf Boat and IRB events, they must be affixed by one end to an individual buoy line so that they float vertically and are of equal distance from the beach.

Where there is more than one area being used it is appropriate to use different coloured turning buoys in each area for board, ski and Oceanman/Oceanwoman craft legs as appropriate (and with matching finish flags) to assist all involved in competition identify and participate in that area.

**Ocean events Flags:** The flags used in ocean events shall be of distinctive colours as described in the rules for the various ocean events in this Rule Book. Where there is more than one arena being used, it is appropriate to use different coloured finish flags for each area with these flags corresponding to the colour of the turning buoys used in each area (see above)

**Note:** When more than one ocean area is used each area may be described by the colour of the turning buoys and flags e.g., pink area, blue area, white area, etc.

#### **Scrutineering procedure**

- For ILS-managed events, a person appointed by the Organising Committee shall check the buoys, flags, poles, beach markers, starting lines etc.
- For ILS LWC or sanctioned events, a declaration from the competition Organisers is required that all equipment to be used in the competition will meet ILS standards.

#### **4.11 Surf Skis**

Surf skis must conform to ILS specifications including the following:

- Weight: minimum 17.5kg (16.5kg from 1 January 2028)\*.
- Length: maximum 5.80m.
- Width: minimum width at widest point of hull is 480mm and shall not include any rubbing strips, moulding or additional protective mouldings.

**Video camera:** If a camera is mounted on the surf ski it must be installed on a mounting device and toggle strap supplied or recommended by the manufacturer of the device. The camera shall be mounted in front of the foot well.

\* The weight of any plugs permanently installed into the craft to attach the camera is included in the overall weight of the craft. The weight of other, non-permanently installed mount and camera are not included in the overall weight.

Detailed specifications for surf skis are described in a separate document located at

<https://www.ilsf.org/lifesaving-sport/rules/irb-specification/>.

#### **Scrutineering procedure**





- When Surf Skis are scrutineered, they shall be checked for maximum length, minimum weight, minimum widths, minimum rocker, and safety (e.g., state of repair). Paddles shall also be checked for competitor safety. Minimum measuring equipment required: tape measure (minimum 10m with 1mm increments); weigh scale (minimum 20 kg capacity with 0.01 kg increments). Also recommended is a measuring “jig” to check rocker and length, and testing gauges to measure minimum rudder and nose diameters, rudder thickness, hull curves and minimum ski width, etc.
- The host Organising Committee shall provide a stamp or sticker to be affixed to each surf ski as proof of the check.  
For ILS LWC or sanctioned events, a declaration from the competition Organisers is required that all pooled skis to be used in the competition will meet ILS standards.





**Note:** If a surf ski is found to be underweight at scrutineering prior to competition, the organiser may allow for weight to be replaced with an approved material provided the material is properly fixed to the craft e.g. Thermoset resin or other approved method such as certified lead weights glued to the deck of the craft. The craft cannot be used in lifesaving competition until the weight is brought up to the correct weight specification.

#### **4.12 Swimwear**

A. Swimwear for both ILS pool and ocean swim events and swim leg of events generally follow World Aquatics (WA) (previously known as FINA) standards for pool swimming events (i.e. not open water, water polo, etc.) and must comply with the following:

- Swimwear worn by men shall not extend above the navel or below the knee.
- Swimwear worn by women shall not cover the neck, shoulders or arms nor extend below the knees. Two-piece swimsuits that conform to this standard may also be worn.

Men's Swimsuits					
Full Length	Long	Long Legs	Knee length	Square Leg	Short
Not Allowed	Not Allowed	Not Allowed	Allowed	Allowed	Allowed
					

Women's Swimsuits				
Full Length	Zippered Back	Knee Length, Open Back	Short, Open Back	Two Piece
Not Allowed	Not Allowed	Allowed	Allowed	Allowed
				

B. The material and construction of swimwear to be worn in all ILS pool and ocean events are:

- Only textile woven fabric(s) shall be permitted.
- The fabric shall be flexible and soft folding.
- Non-woven and/or non-permeable (e.g., synthetic/rubber, wetsuit type) materials shall not be permitted except as a joining seam, an edge, a waistband, or as straps (as per WA standards).
- The material used shall have maximum thickness of 0.8mm.
- Dual layer material is permitted provided the overall maximum thickness is 0.8mm (as per WA standards not including seams, edges, and straps).
- Other than string ties for the tops of men's swimwear, the bottom and top parts of women's two-piece swimwear, and the back of women's one-piece open back swimsuits, no zippers or other fastening systems shall be permitted.
- The swimsuit worn by competitors shall not aid in their buoyancy.
- No outside application on the material shall be permitted. (Note: manufacturer brandings, club names or similar are permitted).
- In addition, swimwear must not:
  - Offend morality and good taste outside of contemporary fashion (in particular, but not exclusively, because of the transparency of the material and/or the cut of the suit).
  - Carry any symbol which may be considered offensive.

**Note 1:** Swimwear stamped as being WA or FINA compliant for Stillwater swimming events shall be acceptable for use in ILS competition.

**Note 2:** Except for swimmers in pool and ocean events, other protective clothing (e.g., shorts, vests, t-shirts, wetsuits etc.) may be worn by competitors in both individual and team events unless otherwise prescribed by these rules or the event organising authority. Vests, t-shirts and shorts, long leg tights, leg stockings and/or compression garments are only permitted to be worn in the pool line throw event and in non-swimming ocean/beach individual events or non-swimming legs of ocean/beach team events.

**Note 3:** Board Paddlers may also wear protective clothing except that sleeves are not permitted to cover the lower arms (i.e. extend beyond the elbows) of competitors unless climatic conditions dictate and are approved by the Chief Referee or their designate.

For rules relating to the wearing of competition attire and swimwear, see Section 2.

***Scrutineering procedure***

When scrutineered a person appointed by the Organising Committee shall check the competitor provided swimwear.